

***italmatic***<sup>®</sup>



**CATALOGO  
ACCESSORI**

*ACCESSORIES CATALOGUE  
CATALOGUE ACCESSOIRES*

**N.20**

Fondata nel 1966, ITALMATIC ha iniziato ad operare nel settore della gomma ed in particolare nella **progettazione, costruzione ed installazione di macchine ed impianti completi per la produzione e la ricostruzione dei pneumatici**, ottenendo in breve tempo un forte riconoscimento internazionale.

Dal 1983 Italmatic ha affiancato al business tradizionale un'ampia gamma di consumabili ed accessori per negozi gommisti e ricostruttori; oggi Italmatic è una società leader nel mondo per la completezza dell'offerta alle aziende che operano nel settore della ricostruzione, riparazione ed assistenza pneumatici. Italmatic produce molti degli articoli trattati tra cui lame di rasatura e raspe, mole carbide e contrappesi di bilanciatura, con rilevanti quote di mercato a livello internazionale.

Ai prodotti di propria fabbricazione viene affiancata la distribuzione, in molti casi in esclusiva, di articoli di primarie aziende internazionali tra le quali ad esempio Mega, Ruff, Patch Rubber, EHA-Alligator, OKU, Kullen, ecc.

Italmatic rivolge la propria offerta:

- ai principali distributori specializzati nel settore del ricambio;
- alle aziende produttrici di autoveicoli e camion (O.E.M.)

Nel corso degli anni, attraverso significativi investimenti tra i quali l'apertura nel 1976 di un secondo stabilimento di 6.000 mq. nei pressi di Lucca, ITALMATIC ha esteso la propria attività a nuove linee di business:

- **Gomme piene industriali superelastiche:** dal 2000 vengono prodotte gomme COMFORT per carrelli elevatori, utilizzando matrici radiali cilindriche in sei settori che garantiscono la massima qualità e performance rispetto alle gomme piene prodotte con la tecnologia tradizionale. Vengono prodotte anche un numero considerevole di presse per il montaggio e lo smontaggio di gomme piene dai cerchi dei carrelli elevatori.
- **Autoclavi:** da oltre 20 anni Italmatic progetta e produce autoclavi per la vulcanizzazione della gomma e per altre applicazioni, tra cui la stratificazione del vetro, il trattamento dei materiali compositi, la fabbricazione di tubi in gomma, ecc.
- **Rivestimento in gomma di cilindri:** dal 1990 Italmatic produce impianti per il rivestimento in gomma di cilindri per il settore della carta, tessile, ecc. e svolge direttamente l'attività di rivestimento.

*Established in 1966, ITALMATIC started operating in the rubber field and, in particular, in the **designing, construction and installation of machines and complete plants to produce and retread tyres**, obtaining in a short time a strong recognition at international level.*

*Since 1983 Italmatic put beside the traditional business a **wide range of consumables and accessories for tyre shops and retreaders**; today Italmatic is a leading company at worldwide level for the completeness of offer to the companies operating in the fields of retreading, repairing and assistance to tyres. Italmatic produces many of the items handled, among which buffing blades and rasps, carbide tools and balancing weights, with relevant market shares at international level.*

*Beside the products of its own manufacture the distribution, in many cases on the exclusivity basis, of primary international companies is put, among which for example Mega, Ruff, Patch Rubber, EHA-Alligator, OKU, Kullen, etc.*

*Italmatic addresses its offer to:*

- *the main skilled distributors in the spare part field;*
- *the companies manufacturing cars and trucks (O.E.M.)*

*In the years, through significant investments among which the establishment in 1976 of a second plant of 6.000 sq.mt. near Lucca, ITALMATIC extended its activities to new business lines:*

- **Superelastic industrial solid tyres:** since 2000 COMFORT tyres for forklifts are produced, employing radial, cylindrical matrices in six segments assuring max. quality and performance compared to solid tyres produced by the traditional technology. Also a considerable number of presses to mount/demount solid tyres onto/from the rims of forklifts are produced.
- **Autoclaves:** since over 20 years Italmatic has been designing and producing autoclaves to cure rubber and for other applications, among which glass stratification, treatment of composite materials, production of rubber hoses, etc.
- **Rollers rubberizing:** since 1990 Italmatic has been producing plants to rubberize rollers for paper, textile fields, etc. and has been carrying out directly the rubberizing activities.

*Établie en 1966, ITALMATIC a commencé à opérer dans le secteur du caoutchouc et, en particulier, dans le **projet, la construction et l'installation de machines et d'installations complètes pour la production et le rechapage de pneus**, en obtenant sous peu de temps une forte reconnaissance à niveau international.*

*Depuis 1983 Italmatic a flanqué le business traditionnel d'une **ample gamme de consommables et d'accessoires pour négoces pneus et rechapageurs**; Aujourd'hui Italmatic est une compagnie leader dans le monde pour le caractère exhaustif de l'offre aux sociétés qui opèrent dans les secteurs de rechapage, réparation et assistance aux pneus. Italmatic produit beaucoup des articles traités, entre lesquels les lames de râpage et râpes, meules carbides et masses d'équilibrage, avec des parts de marché importantes à niveau international.*

*Aux produits de sa fabrication, elle flanque la distribution, en beaucoup de cas en exclusive, d'articles de sociétés internationales primaires, entre lesquelles par exemple Mega, Ruff, Patch Rubber, EHA-Alligator, OKU, Kullen, etc.*

*Italmatic adresse son offre:*

- *aux distributeurs spécialisés principaux du secteur du rechange;*
- *aux sociétés productrices de voitures et camions (Première Monte)*

*Au cours des années, à travers des investissements significatifs, entre lesquels l'ouverture en 1976 d'un deuxième établissement à 6.000 mt. carrés près de Lucca, ITALMATIC a étendu son activité à des nouvelles lignes de business:*

- **Pneus pleins industriels superélastiques:** depuis 2000 on produit des pneus COMFORT pour chariots élévateurs, en utilisant des matrices radiales, cylindriques, en six secteurs qui assurent la qualité et les performances maximums comparé aux pneus pleins produits par la technologie traditionnelle. On produit aussi une quantité considérable de presses pour le montage/démontage des pneus pleins des jantes des chariots élévateurs.
- **Autoclaves:** depuis plus de 20 ans Italmatic projète et produit autoclaves pour la vulcanisation du caoutchouc et pour d'autres applications, entre lesquelles la stratification du verre, le traitement des matériaux composites, la fabrication de tuyaux en caoutchouc, etc.
- **Habillage en caoutchouc des cylindres:** depuis 1990 Italmatic produit des installations pour l'habillage en caoutchouc de cylindres pour le secteur du papier, textile, etc. et elle exerce l'activité d'habillage directement.



# **italmatic**

Gamma completa di accessori e consumabili per la ricostruzione, riparazione, cura ed assistenza pneumatici.

*Complete range of accessories and consumables for retreading, repairing, care and assistance of tyres.*

*Gamme complète d'accessoires et consommables pour rechapage, réparation, soin et assistance des pneus.*



Il presente catalogo è di proprietà ITALMATIC s.r.l. - Ne è vietata la riproduzione, anche parziale, senza autorizzazione.

*This catalogue is ITALMATIC s.r.l. property - Its even partial reproduction without authorization is forbidden.*

*Ce catalogue est propriété d'ITALMATIC s.r.l. - Sa reproduction même partielle sans autorisation est interdite.*

Italmatic si riserva il diritto di modificare i prodotti in qualsiasi momento senza alcun preavviso. Immagini e colori sono da considerarsi puramente indicativi.















*Italmatic reserve themselves the right to modify the products in any moment without any notice: Images and colours are only indicative.*





*Italmatic se réserve le droit de modifier les produits à n'importe quel moment sans aucun préavis. Images et couleurs doivent être considérés seulement indicatifs.*











**[www.italmatic.net](http://www.italmatic.net)**

**Accessori ricostruzione**  
**Retreading accessories**  
**Accessoires pour le rechapage**

	<b>PUNTE IN ACCIAIO PER RASPE E RULLINI</b> <i>STEEL NAILS FOR RASPS AND ROLLERS</i> <i>AIGUILLES EN ACIER POUR RÂPES ET ROULEAUX</i>	Pag. 8
	<b>LAME DI RASPATURA ITALMATIC</b> <i>ITALMATIC BUFFING BLADES</i> <i>LAMES DE RÂPAGE ITALMATIC</i>	Pag. 8
	<b>RASPE ITALMATIC</b> <i>ITALMATIC RASPS</i> <i>RÂPES ITALMATIC</i>	Pag. 10
	<b>DISTANZIALI ITALMATIC PER RASPA</b> <i>ITALMATIC RASP SPACERS</i> <i>INTERCALAIRES ITALMATIC POUR RÂPE</i>	Pag. 11
	<b>PERNI ITALMATIC</b> <i>ITALMATIC PINS</i> <i>GOUJONS ITALMATIC</i>	Pag. 11
	<b>SCORTICATORI E SGORBIE ITALMATIC</b> <i>ITALMATIC PEELING TEETH AND GOUGES</i> <i>ÉCORCHEURS ET GOUGES ITALMATIC</i>	Pag. 12
	<b>MOLE ED UTENSILI CARBIDE ITALMATIC</b> <i>ITALMATIC CARBIDE WHEELS AND TOOLS</i> <i>MEULES ET OUTILS CARBIDE ITALMATIC</i>	Pag. 13
	<b>ESTRUSORI PORTATILI</b> <i>PORTABLE EXTRUDERS</i> <i>EXTRUDEUSES PORTATIVES</i>	Pag. 17
	<b>SPAZZOLE</b> <i>BRUSHES</i> <i>BROSSES</i>	Pag. 19
	<b>MOLE PER METALLO E GOMMA</b> <i>WHEELS FOR METALLIC AND RUBBER</i> <i>MEULES POUR MÉTAL ET CAOUTCHOUC</i>	Pag. 21
	<b>RULLINI E RASPETTE</b> <i>STITCHERS AND RASPS</i> <i>ROULEAUX ET RÂPES</i>	Pag. 22
	<b>SMERIGLIATRICI PROFESSIONALI</b> <i>PROFESSIONAL GRINDERS</i> <i>PONCEUSES PROFESSIONNELLES</i>	Pag. 23
	<b>ACCESSORI DA TAGLIO</b> <i>TOOLS FOR CUTTING</i> <i>ACCESSOIRES À COUPER</i>	Pag. 24
	<b>PORTALAMETTE E LAMETTE</b> <i>TYRE TRIMMING TOOLS AND TRIMMING BLADES</i> <i>PORTE-LAMES ET LAMES À ÉBARBER</i>	Pag. 25
	<b>ACCESSORI E RICAMBI VARI</b> <i>ACCESSORIES AND SPARE PARTS</i> <i>ACCESSOIRES ET PIÈCES DE RECHANGE</i>	Pag. 26

	<b>ACCESSORI ANTINFORTUNISTICA</b> <i>ACCESSORIES FOR INDUSTRIAL ACCIDENTS PREVENTION</i> <i>ACCESSOIRES POUR LA PRÉVENTION DES ACCIDENTS SUR LE TRAVAIL</i>	Pag. 37
	<b>CAMERE DI COTTURA</b> <i>CURING TUBES</i> <i>CHAMBRES DE CUISSON</i>	Pag. 38
	<b>FUSTINI DI COTTURA</b> <i>CURING BLADDERS</i> <i>MEMBRANES DE CUISSON</i>	Pag. 40
	<b>ENVELOPES</b> <i>ENVELOPES</i> <i>ENVELOPES</i>	Pag. 41
	<b>PRODOTTI CHIMICI E ACCESSORI</b> <i>CHEMICAL PRODUCTS AND ACCESSORIES</i> <i>PRODUITS CHIMIQUES ET ACCESSOIRES</i>	Pag. 46

**Accessori per negozi gommisti**  
*Accessories for tyre shops*  
*Accessoires pour vendeurs et réparateurs de pneus*

	<b>CRICCHI A BOTTIGLIA</b> <i>BOTTLE JACKS</i> <i>CRICS À BOUTEILLE</i>	Pag. 50
	<b>CRICCHI A CARRELLO</b> <i>TROLLEY JACKS</i> <i>CRICS À CHARIOT</i>	Pag. 52
	<b>PIATTAFORME, TAVOLI E CUSCINI DI SOLLEVAMENTO</b> <i>LIFTING PLATFORMS, TABLES AND PADS</i> <i>PLATE-FORMES, TABLES ET COUSSINS DE LEVAGE</i>	Pag. 55
	<b>TAMPONI IN GOMMA PER PONTI SOLLEVATORI</b> <i>RUBBER PADS FOR AUTO LIFTS</i> <i>TAMPONS EN CAOUTCHOUC POUR PONTS ÉLEVATEURS</i>	Pag. 56
	<b>TAMPONI PER STAZIONAMENTO</b> <i>PADS FOR PARKING</i> <i>TAMPONS POUR STATIONNEMENT</i>	Pag. 58
	<b>RUOTE PER PICCOLI CARRELLI E CARRIOLE</b> <i>TYRES FOR SMALL TROLLEYS AND BARROWS</i> <i>PNEUS POUR PETIT CHARIOTS ET BROUETTES</i>	Pag. 59
	<b>VULCANIZZATORI PNEUMATICI E MANUALI</b> <i>MANUAL AND PNEUMATIC VULCANIZERS</i> <i>VULCANISATEURS PNEUMATIQUES ET MANUELS</i>	Pag. 61
	<b>VULCANIZZATORI PER PNEUMATICI OTR</b> <i>OTR TYRE VULCANIZERS</i> <i>VULCANISATEURS POUR PNEUS OTR</i>	Pag. 62

	<b>RIGATORI</b> <i>GROOVERS</i> <i>SCULPTEURS</i>	Pag. 63
	<b>DISPOSITIVI DI GONFIAGGIO OMOLOGATI CE</b> <i>INFLATING DEVICES EC HOMOLOGATED</i> <i>DISPOSITIFS DE GONFLAGE HOMOLOGUÉS CE</i>	Pag. 66
	<b>MISURATORI DI PRESSIONE OMOLOGATI CE</b> <i>PRESSURE MEASURERS EC HOMOLOGATED</i> <i>MESUREURS DE PRESSION HOMOLOGUÉS CE</i>	Pag. 68
	<b>DISPOSITIVI DI GONFIAGGIO AUTOMATICI ARIA E AZOTO</b> <i>AUTOMATIC AIR AND NITROGEN INFLATION DEVICES</i> <i>DISPOSITIFS DE GONFLAGE AUTOMATIQUES AIR ET AZOTE</i>	Pag. 70
	<b>TUBERIA</b> <i>AIR HOSES</i> <i>TUYAUX AIR</i>	Pag. 72
	<b>GONFIATORI PORTATILI</b> <i>PORTABLE INFLATORS</i> <i>GONFLEURS PORTABLES</i>	Pag. 73
	<b>PISTOLE PER SOFFIAGGIO ARIA</b> <i>AIR BLOWING GUNS</i> <i>PISTOLETS POUR SOUFFLAGE AIR</i>	Pag. 73
	<b>LAMPADE ED AVVOLGITORI CAVI ELETTRICI</b> <i>LAMPS AND ELECTRIC CABLES WINDERS</i> <i>LAMPES ET ENROULEURS DE CÂBLES ÉLECTRIQUES</i>	Pag. 74
	<b>ATTREZZATURE PER CHIODATURA E DISPOSITIVI ANTINEVE</b> <i>TYRE STUDDING EQUIPMENTS AND ANTISNOW DEVICES</i> <i>ÉQUIPEMENTS POUR LE CLOUAGE DES PNEUS ET DISPOSITIFS ANTINEIGE</i>	Pag. 75
	<b>LEVE</b> <i>LEVERS</i> <i>LEVIERS</i>	Pag. 76
	<b>BUSSOLE E AVVITATORI</b> <i>IMPACT SOCKETS AND IMPACT WRENCHES</i> <i>DOUILLES ET CLEFS DE VISSAGE</i>	Pag. 79
	<b>CHIAVI DINAMOMETRICHE PROFESSIONALI</b> <i>PROFESSIONAL DYNAMOMETRIC WRENCHES</i> <i>CLEFS DYNAMOMÉTRIQUES PROFESSIONNELLES</i>	Pag. 85
	<b>VALVOLE ED ACCESSORI</b> <i>VALVES AND ACCESSORIES</i> <i>VALVES ET ACCESSOIRES</i>	Pag. 86
	<b>CONNETTORI E INDICATORI DI CONTROLLO PER DADI</b> <i>CONNECTORS AND INDICATORS FOR TRUCK WHEEL NUTS</i> <i>CONNECTEURS ET INDICATEURS POUR ÉCROUS</i>	Pag. 124
	<b>COPERCHIETTI PER DADI CERCHI AUTOCARRO E VETTURA</b> <i>TRUCK AND CARS WHEEL NUT CAPS</i> <i>BOUCHONS POUR ÉCROUS JANTES CAMION ET VOITURE</i>	Pag. 125



**TASSELLI E COLONNETTE**  
*SMALL BLOCKS AND STUDS*  
*PETITS BLOCS ET BOULONS*

Pag. 126



**ATTREZZI PER CONTRAPPESI**  
*TOOLS FOR BALANCING WEIGHTS*  
*OUTILS POUR MASSES D'ÉQUILIBRAGE*

Pag. 128



**CONTRAPPESI DI BILANCIATURA IN PIOMBO**  
*LEAD BALANCING WEIGHTS*  
*MASSES D'ÉQUILIBRAGE EN PLOMB*

Pag. 130

**CONTRAPPESI DI BILANCIATURA IN PIOMBO - PACKING LIST**  
*LEAD BALANCING WEIGHTS - PACKING LIST*  
*MASSES D'ÉQUILIBRAGE EN PLOMB - LISTE DE COLISAGE*

Pag. 134



**CONTRAPPESI DI BILANCIATURA SENZA PIOMBO**  
*NO LEAD BALANCING WEIGHTS*  
*MASSES D'ÉQUILIBRAGE SANS PLOMB*

Pag. 135

**CONTRAPPESI DI BILANCIATURA SENZA PIOMBO - PACKING LIST**  
*NO LEAD BALANCING WEIGHTS - PACKING LIST*  
*MASSES D'ÉQUILIBRAGE SANS PLOMB - LISTE DE COLISAGE*

Pag. 142



**SISTEMA DI BILANCIATURA ECOLOGICO CON MICROSFERE**  
*BALANCING SYSTEM WITH MICROBEADS*  
*SYSTEME D'ÉQUILIBRAGE AVEC MICROSPHÈRES*

Pag. 143



**MATERIALE AUTOVULCANIZZANTE PATCH RUBBER**  
*PATCH RUBBER SELF-CURING MATERIAL*  
*MATÉRIEL AUTOVULCANISANT PATCH RUBBER*

Pag. 145



**PASTA MONTAGGIO PNEUMATICI**  
*PASTE TO MOUNT TYRES*  
*PÂTE POUR LE MONTAGE DES PNEUS*

Pag. 168



**GESSI**  
*CHALKS*  
*CRAIES*

Pag. 170



**ARTICOLI VARI**  
*DIFFERENT ITEMS*  
*ARTICLES DIFFÉRENTS*

Pag. 171



**STALLONATORI**  
*BEAD BREAKERS*  
*DÉ TALONNEURS*

Pag. 174



**ATTREZZATURE VARIE**  
*VARIOUS EQUIPMENTS*  
*ÉQUIPEMENTS DIVERS*

Pag. 175



**CUFFIE UNIVERSALI PER GIUNTI**  
*UNIVERSAL SHROUDS FOR JOINTS*  
*CACHES UNIVERSELLES POUR JOINTS*

Pag. 184

**INDICE ALFABETICO**  
*ALPHABETIC INDEX*  
*INDEX ALPHABÉTIQUE*

Pag. 188

# **ACCESSORI RICOSTRUZIONE**

*RETREADING ACCESSORIES  
ACCESSOIRES POUR LE RECHAPAGE*





**PUNTE IN ACCIAIO PER RASPE E RULLINI**  
**STEEL NAILS FOR RASPS AND ROLLERS**  
**AIGUILLES EN ACIER POUR RÂPES ET ROULEAUX**

Codice Code Code	Dimensioni Sizes Dimensions	Confezione Box Conditionnement
2010002	1,5 x 10	3.000 pcs.
2010003	1,5 x 12	3.000 pcs.
2010004	2 x 17	5.000 pcs.
2010005	2,5 x 17	10.000 pcs.
2010006	2 x 20	5.000 pcs.
2010007	2,5 x 20	5.000 pcs.
2010008	2 x 22	10.000 pcs.
2010009	2,5 x 25	5.000 pcs.



**LAME DI RASPATURA ITALMATIC**  
**ITALMATIC BUFFING BLADES**  
**LAMES DE RÂPAGE ITALMATIC**



Codice Code Code	Modello Model Modèle	Numero lame per set Number of blades per set Numéro de lames par jeu	Numero set per scatola Number of sets per box Numéro de jeux par boîte	Numero lame per scatola Number of blades per box Numéro de lames par boîte
2020010	I - 3 - 25	28	50	1.400
2020011	I - 3 - 24	28	50	1.400
2020013	I - 156 - 17/18	32	50	1.600



Codice Code Code	Modello Model Modèle	Numero lame per set Number of blades per set Numéro de lames par jeu	Numero set per scatola Number of sets per box Numéro de jeux par boîte	Numero lame per scatola Number of blades per box Numéro de lames par boîte
2020014	Long life II US (I-4-20)	28	50	1.400
2020015	I - 4 - 25	28	50	1.400
2020016	I - 4 - 24	28	50	1.400
2020017	I - 4 - 16	28	50	1.400
2020018	Long life II EUROPA	28	50	1.400



Codice Code Code	Modello Model Modèle	Numero lame per set Number of blades per set Numéro de lames par jeu	Numero set per scatola Number of sets per box Numéro de jeux par boîte	Numero lame per scatola Number of blades per box Numéro de lames par boîte
2020019	I - 115 - 20	25	50	1.250
2020020	I - 115 - 25	25	50	1.250
2020020S	I - 115 - 25 SUPERVENT	25	50	1.250
2020021	I - 115 - 24	25	50	1.250
2020022	I - 115 - 16	25	50	1.250
2020023	Long life III	30	50	1.500
2020023B	Long life III B	30	50	1.500

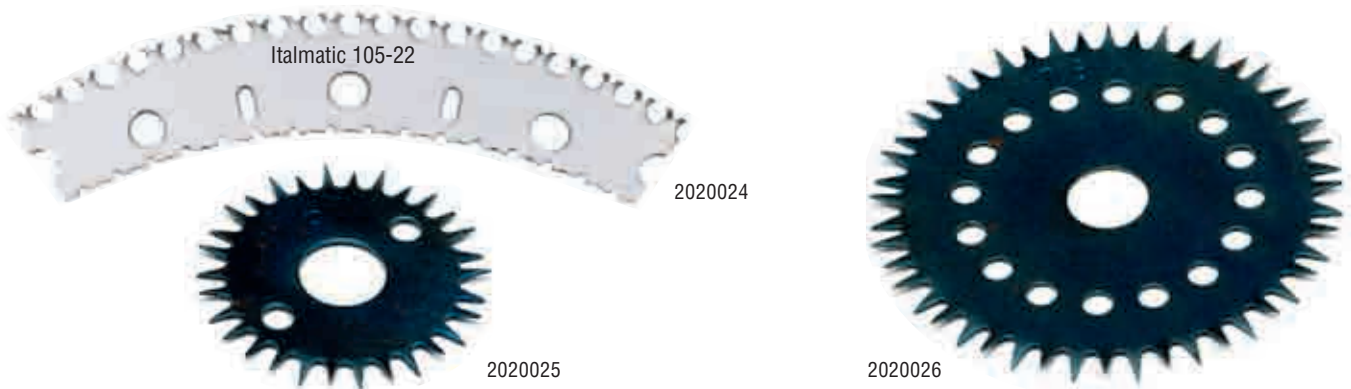

Codice Code Code	Modello Model Modèle	Numero lame per set Number of blades per set Numéro de lames par jeu	Numero set per scatola Number of sets per box Numéro de jeux par boîte	Numero lame per scatola Number of blades per box Numéro de lames par boîte
2020024	I - 105 - 22	35	40	1.400
2020025	I - 5	5	1	5
2020026	I - 6	6	1	6

Codice Code Code	Descrizione Description Description
2020028	Scorticatore diritto/Peeling tooth/Lamette à écorcher
2020029	Affila lama completo di mola Blades sharpener c/w sharpening tool Affûteuse de lames avec meule
2020030	Mola smeriglio per affila lama 150x50x20 Spare sharpening tool for blades sharpener 150x50x20 Meule-émeri pour affûteuse de lames 150x50x20



# RASPE ITALMATIC

## ITALMATIC RASPS

## RÂPES ITALMATIC

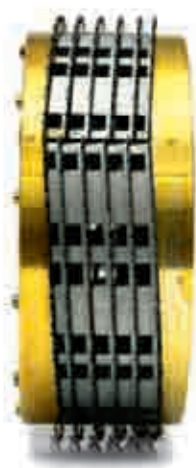

2030036



2030038



2030042



2030043



2030040



2030048



2030049

Codice Code Code	Modello Model Modèle	Foro Hole Forure	Chiavette Keyways Clavettes	Altezza Height Hauteur	Perni Pins Goujons	Ø esterno Ø external Ø extérieur
2030031	I - 156 - AP	Ø 25	–	H 96	Ø 6,3	155
2030032	I - 4 AP	Ø 32	n° 2 (10 mm)	H 85	Ø 6,3	227
2030033	I - 4 NS	Ø 32	n° 2 (10 mm)	H 85	Ø 6,3	227
2030034	I - 4 NS	Ø 40	n° 2 (10 mm)	H 85	Ø 6,3	227
2030035	I - 4 AP CONVEX	Ø 32	n° 2 (10 mm)	H 96	Ø 6,3	240
2030036	LL II AP BANDAG	Ø 32	n° 2 (10 mm)	H 96	Ø 8	227
2030037	LL II USA AP	Ø 32	n° 2 (10 mm)	H 96	Ø 6,3	227
2030038	I - 115 NS	Ø 32	n° 2 (10 mm)	H 78	Ø 8	291
2030039	I - 115 NS	Ø 40	n° 2 (10 mm)	H 78	Ø 8	291
2030040	I - 115 SPECIAL <div style="display: inline-block; vertical-align: middle; margin-left: 10px;">                     { con scorticatori                      c/w peeling teeth                      avec lamettes à écorcher                 </div>	Ø 40	n° 2 (10 mm)	H 72	Ø 8	291
2030041	LL III AP	Ø 40	n° 2 (10 mm)	H 96	Ø 8	291
2030042	LL III AP CONVEX	Ø 40	n° 2 (10 mm)	H 96	Ø 8	305
2030043	I - 105 REGULAR	Ø 32	n° 2 (10 mm)	H 102	Ø 8	267
2030048	I - 5	Ø est. / out. / ext. 43		Gambo / stem / tige Ø 6		43
2030049	I - 6	Ø est. / out. / ext. 74		Gambo / stem / tige Ø 6		74

- In sede d'ordine, per favore specificare spessore distanziali e tipo lama.
- When placing your order, please specify spacers thickness and type of blade.
- Au moment de Vt. commande, svp indiquez épaisseur des intercalaires et type de lame.

- Su richiesta realizzazione di raspe per qualsiasi esigenza.
- Upon request we manufacture rasps for any need.
- Sur demande nous fabriquons râpes pour toutes nécessités.

**DISTANZIALI ITALMATIC PER RASPA**  
**ITALMATIC RASP SPACERS**  
**INTERCALAIRES ITALMATIC POUR RÂPE**

italmatic

Codice Code Code	Modello Model Modèle
2040050	156 x 1/4"
2040051	156 x 3/8"
2040052	4 x 1/4"
2040053	4 x 3/8"
2040054	LL II x 1/4" USA
2040055	LL II x 3/8" USA
2040056	LL II x 1/4" EUROPA
2040057	LL II x 3/8" EUROPA
2040058	105 x 1/4"
2040059	105 x 3/8"
2040060	115 x 1/4"
2040061	115 x 3/8"
2040062	LL III x 1/4"
2040063	LL III x 3/8"

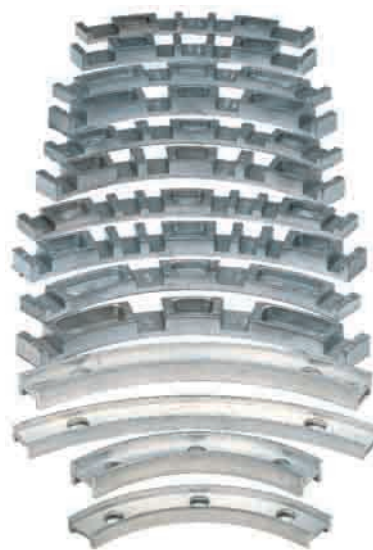

**PERNI ITALMATIC**  
**ITALMATIC PINS**  
**GOUJONS ITALMATIC**

**Perni zigrinati - Knurled pins - Goujons crénelés**

Codice Code Code	Dimensioni Sizes Dimensions	Tipo raspa Type of rasp Type de râpe
2040065	Ø 6,3 x 85	I - 4
2040066	Ø 6,3 x 96	I - 156 / I - 4
2040067	Ø 6,3 x 102	I - 4
2040068	Ø 8 x 78	I - 115
2040069	Ø 8 x 85	I - 115
2040070	Ø 8 x 96	I - 115 / LL II E / LL III
2040071	Ø 8 x 102	I - 105



**Perni zigrinati speciali - Special knurled pins - Goujons crénelés spéciaux**

Codice Code Code	Dimensioni / Modello Sizes / Model Dimensions / Modèle	Tipo raspa Type of rasp Type de râpe
2040072	Ø 8 x 72	I - 115 Special
2040073	Perno cilindrico porta scorticatori Cylindrical pin supporting peeling teeth Goujon cylindrique supportant les écorcheurs	
2040074	Perno fresato porta scorticatori Milled pin supporting peeling teeth Goujon fraisé supportant les écorcheurs	



2040073



2040074

**Perni sagomati - Shaped pins - Goujons modelés**

Codice Code Code	Dimensioni Sizes Dimensions	Tipo raspa Type of rasp Type de râpe
2040075	Ø 6,3 x 96	I - 4 CONVEX
2040076	Ø 8 x 96	I - 115 / LL III



**SCORTICATORI E SGORBIE ITALMATIC**  
**ITALMATIC PEELING TEETH AND GOUGES**  
**ÉCORCHEURS ET GOUGES ITALMATIC**



2040080



2040081



2040082



2040083



2040084



2040085



2040086



2040087



2040088

<b>Codice</b> <i>Code</i> <i>Code</i>	<b>Dimensioni</b> <i>Sizes</i> <i>Dimensions</i>	<b>Modello</b> <i>Model</i> <i>Modèle</i>
<b>2040080</b>	Ø 80 x 90 x 40	Scorticatore cilindrico - <i>Cylindrical peeling tooth</i> - <i>Écorcheur cylindrique</i>
<b>2040081</b>	Ø 60 x 70 x 30	Scorticatore cilindrico - <i>Cylindrical peeling tooth</i> - <i>Écorcheur cylindrique</i>
<b>2040082</b>	Ø 70 x 85 x 45	Scorticatore conico <i>Conical peeling tooth</i> <i>Écorcheur conique</i>
<b>2040082A</b>	Ø 83 x 100 x 50	Scorticatore conico per Matic PL 20 & PL 80 <i>Conical peeling tooth for Matic PL 20 &amp; PL 80</i> <i>Écorcheur conique pour Matic PL 20 &amp; PL 80</i>
<b>2040083</b>	–	Scorticatore speciale a ferro di cavallo <i>Special horse-shoe peeling tooth</i> <i>Écorcheur spécial en forme de fer à cheval</i>
<b>2040083A</b>	–	Scorticatore riscaldato a ferro di cavallo per Matic PL 20 & PL 80 <i>Heated horse-shoe peeling tooth for Matic PL 20 &amp; PL 80</i> <i>Écorcheur chauffé en forme de fer à cheval pour Matic PL 20 &amp; PL 80</i>
<b>2040084</b>	Ø est/out/ext 25 Ø int/ins/int 20 - H 45 Gambo/Stem/Tige Ø 7	Sgorbia cilindrica <i>Cylindrical gouge</i> <i>Gouge cylindrique</i>
<b>2040085</b>	Ø est/out/ext 45 Ø int/ins/int 40 - H 45 Gambo/Stem/Tige Ø 7	Sgorbia cilindrica <i>Cylindrical gouge</i> <i>Gouge cylindrique</i>
<b>2040086</b>	Ø est/out/ext 30	Sgorbia a tazza - <i>Cup gouge</i> - <i>Gouge en forme de tasse</i>
<b>2040087</b>	Ø est/out/ext 50	Sgorbia a tazza - <i>Cup gouge</i> - <i>Gouge en forme de tasse</i>
<b>2040088</b>	Ø est/out/ext 50	Sgorbia a tazza Ø est. 50 con nocche <i>Cup gouge out. Ø 50 with knuckles</i> <i>Gouge en forme de tasse Ø Ext. 50 avec noeuds</i>

- Per favore specificare sempre il tipo di grana desiderato
- Please always specify the type of grit you desire
- Svp, indiquez toujours le type de grain désiré



**UW** **Mola combinata**  
**Unit wheel**  
**Meule combinée**

Codice Code Code	Dimensioni Sizes Dimensions	Foro Hole Forure
2050100	Ø 50 x 25	14
2050101	Ø 76 x 25	14
2050102	Ø 102 x 25	14
2050103	Ø 102 x 38	14



**CW** **Mola a profilo curvo**  
**Contour wheel**  
**Meule à profil courbe**

Codice Code Code	Dimensioni Sizes Dimensions	Foro Hole Forure
2050110	Ø 50 x 25	3/8" x 24 UNF
2050111	Ø 65 x 13	10
2050112	Ø 76 x 32	14
2050113	Ø 102 x 38	14
2050114	Ø 150 x 38	60



**UWF** **Mola speciale per raspatura fianchi**  
**Sidewall buffing wheel**  
**Meule spéciale pour le râpage des flancs**

Codice Code Code	Dimensioni Sizes Dimensions	Foro Hole Forure	Chiavette Keyways Clavettes
2050120	Ø 150 x 25	60	-
2050121	Ø 150 x 38	32 RTS	n° 2 (10 mm)
2050122	Ø 150 x 38	60	-
2050123	Ø 200 x 25	60	-
2050124	Ø 200 x 38	60	-
2050125	Ø 225 x 25	60	-
2050126	Ø 225 x 38	60	n° 2 (10 mm)
2050127	Ø 270 x 60	32	n° 2 (10 mm)



**CWG** **Mola a profilo curvo**  
**Contour wheel**  
**Meule à profil courbe**

Codice Code Code	Dimensioni Sizes Dimensions	Foro Hole Forure
2050130	Ø 150 x 25	60
2050131	Ø 150 x 38	60



# MOLE ED UTENSILI CARBIDE ITALMATIC

## ITALMATIC CARBIDE WHEELS AND TOOLS

### MEULES ET OUTILS CARBIDE ITALMATIC

#### RFBOT **Mola rotonda** *Round face buff out tool* *Meule ronde*

Codice Code Code	Dimensioni Sizes Dimensions	Foro Hole Forure
2050140	Ø 50 x 3,5	3/8" x 24 UNF
2050141	Ø 50 x 5	3/8" x 24 UNF
2050142	Ø 50 x 7	3/8" x 24 UNF
2050143	Ø 50 x 10	3/8" x 24 UNF
2050144	Ø 50 x 13	3/8" x 24 UNF
2050145	Ø 50 x 19	3/8" x 24 UNF
2050146	Ø 70 x 3,5	3/8" x 24 UNF
2050147	Ø 100 x 3,5	3/8" x 24 UNF



#### CAYMAN **Mola con gambo Cayman** *Cayman wheel c/w stem* *Meule Cayman complète de tige*

Codice Code Code	Dimensioni Sizes Dimensions	Gambo Stem Tige
2050148	Ø 50 x 3	Ø 6
2050149	Ø 50 x 12	Ø 6



2050148



2050149

#### TBOTP **Mola conica** *Tapered buff out tool* *Meule conique*

Codice Code Code	Dimensioni Sizes Dimensions	Foro Hole Forure
2050150	Ø 19 x 38	3/8" x 24 UNF
2050151	Ø 19 x 50	3/8" x 24 UNF
2050152	Ø 25 x 50	3/8" x 24 UNF
2050153	Ø 19 x 102	3/8" x 24 UNF
2050154	Ø 25 x 102	3/8" x 24 UNF



#### DW **Mola smerigliatura fianchi** *Sidewall buffing wheel* *Meule-émeri pour les flancs*

Codice Code Code	Dimensioni Sizes Dimensions	Foro Hole Forure
2050158	Ø 50 x 10	10
2050159	Ø 75 x 16	14
2050160	Ø 100 x 13	14
2050161	Ø 100 x 19	18
2050162	Ø 125 x 25	18
2050163	Ø 125 x 25	50
2050163A	Ø 150 x 15	60
2050164	Ø 150 x 32	18
2050165	Ø 150 x 32	60



**PR Raspetta a matita - Pencil rasp - Râpe en forme de crayon**

Codice Code Code	Dimensioni Sizes Dimensions	Gambo Stem Tige
2050170	Ø 6 x 65	Ø 6
2050171	Ø 6 x 102	Ø 6



**PRB Raspetta sferica - Ball rasp - Râpe sphérique**

Codice Code Code	Dimensioni Sizes Dimensions	Gambo Stem Tige
2050172	Ø 20 x 55	Ø 6



**FD Disco piatto - Flat disc - Disque plat**

Codice Code Code	Dimensioni Sizes Dimensions		Gambo Stem Tige
2050178	Ø 125 x 2	22	-
2050179	Ø 125 x 2	22	Areato - Ventilated - Aéré
2050180	Ø 175 x 2	22	-
2050181	Ø 175 x 2	22	Areato - Ventilated - Aéré
2050182	Ø 200 x 2	30	-



2050178



2050181



2050180

**ID Tubo carbide/Abrasivo - Carbide tube/Abrasive - Tube carbide/Abrasif**

Codice Code Code	Dimensioni Sizes Dimensions	Spessore tubo Tube thickness Épaisseur du tube
2050190	Ø 30 x 30 Carbide	2
2050191	Ø 45 x 30 Carbide	2
2050192	Ø 75 x 30 Carbide	2
2050193A	Ø 30 x 30 Abrasive	1
2050193B	Ø 45 x 30 Abrasive	1



2050193A

**Adattatore per tubo carbide - Adaptor for carbide tube - Adaptateur pour tube carbide**

Codice Code Code	Dimensioni Sizes Dimensions	Gambo Stem Tige
2050194	Ø 30 x 30	Ø 6
2050195	Ø 45 x 30	Ø 6
2050196	Ø 75 x 30	Ø 8





# MOLE ED UTENSILI CARBIDE ITALMATIC

## ITALMATIC CARBIDE WHEELS AND TOOLS

### MEULES ET OUTILS CARBIDE ITALMATIC

#### CD Disco per taglio fascia prestampato

*Abrasive cutting disc for precured tread*  
*Disque à couper la bande prévulcanisée*

Codice Code Code	Dimensioni Sizes Dimensions	Foro Hole Forure
2050199	Ø 150 x 2	50
2050200	Ø 160 x 2	32
2050201	Ø 180 x 2	32
2050202	Ø 200 x 2,5	30
2050203	Ø 300 x 3,5	35



2050200

#### GW Mola per rettifica pneumatici

*Wheel for tyres' grinding machine*  
*Meule pour rectifieuse*

Codice Code Code	Dimensioni Sizes Dimensions	Foro Hole Forure
2050210	Ø 145 x 150	30
2050211	Ø 160 x 60	32



2050211

#### SW Mola a stella - Star wheel - Meule en forme d'étoile

Codice Code Code	Dimensioni Sizes Dimensions	Foro Hole Forure
2050219	Ø 57 x 9,5	10
2050220	Ø 150 x 5 x 15 H	60
2050221	Ø 150 x 5 x 30 H	60



2050219



2050221

#### RG Mola carbide per sgrossare e rettificare i cilindri rivestiti in gomma

*Carbide wheel to rough and to grind rubberized cylinders*  
*Meule carbide pour dégrossir et pour rectifier les cylindres habillés en caoutchouc*

Codice Code Code	Dimensioni Sizes Dimensions	Grana Grit Grain	Foro Hole Forure
2050230	Ø 160 x 40	60 / 16	on request
2050231	Ø 200 x 40	60 / 16	on request
2050232	Ø 250 x 60	80 / 18	on request
2050233	Ø 400 x 60	60 / 16	on request



2050232

- Su richiesta realizzazione di mole per qualsiasi esigenza
- Upon request manufacturing of wheels for any need
- Sur demande nous fabriquons meules pour toutes nécessités

#### Adattatore per mole - Adaptor for wheels - Adaptateur pour meules

Codice Code Code	Dimensioni Sizes Dimensions	Gambo Stem Tige	Mole corrispondenti Corresponding wheels Meules correspondantes
2050240	Ø 3/8" x 24 UNF H 47	Ø 6	RFBOT / CW
2050241	Ø 1/2" w H 52	Ø 6	I-5 / I-6 blades
2050242	Ø10 mm H 60	Ø 6	CW 65 x 13
2050243	M 14x2 H 80	Ø 8	CW 76 x 32



2050240

2050241



2050242

2050243

- Su richiesta realizzazione di bocche per qualsiasi esigenza
- Upon request manufacturing of bushings for any need
- Sur demande fabrication de boucles pour toutes nécessités



2060245B



2060246



2060247



2060248

**Estrusori portatili per riempimento dei crateri di riparazione**  
**Portable extruders for filling up cracks**  
**Extrudeuses portatives pour le remplissage des cratères de réparation**

Codice Code Code	Modello Model Modèle	Produzione gomma Rubber production Production caoutchouc	Potenza in watt Watt power Puissance en watt	Resistenza elettrica Heating element Résistance électrique	Consumo aria Air consumption Consommation de l'air	Peso kg Weight kg Poids kg	Temp. di estrusione Extruding temperature Température d'extrusion
2060245	<b>MINIEXTRUDER</b> Ingersoll	18 kg/H	550 watt	350 watt 220 V / 110 V	12,5 lt/sec	3,8	0-120 °C
2060245B	<b>MINIEXTRUDER</b> Bosch	18 kg/H	550 watt	350 watt 220 V / 110 V	12,5 lt/sec	3,8	0-120 °C
2060246	<b>MAGNUM</b>	24 kg/H	550 watt	350 watt 220 V / 110 V	12,5 lt/sec	4,3	0-120 °C
2060247	<b>GIANT</b>	28 kg/H	750 watt	800 watt 220 V / 110 V	13,5 lt/sec	4,5	0-120 °C
2060248	<b>EM</b>	40 kg/H	1050 watt	800 watt 220 V / 110 V	Elettrico Electrical/Électrique	7	0-120 °C

# ESTRUSORI PORTATILI

## PORTABLE EXTRUDERS

### EXTRUDEUSES PORTATIVES

#### Optionals e parti di ricambio

#### Optionals and spare parts

#### Options et pièces de rechange

Codice Code Code	Descrizione Description Description
2060250	Bilanciatore da 2÷4 kg / Balancer with 2÷4 kg capacity Compensateur 2÷4 kg
2060251	Bilanciatore da 6÷8 kg / Balancer with 6÷8 kg capacity Compensateur 6÷8 kg
2060252	Cavalletto per estrusore portatile / Portable extruder stand Support pour extrudeuse portative
2060253	Parte frontale estrusore portatile Front body for minieextruder Partie frontale pour mini extrudeuse
2060254	Ugello per estrusore portatile - Codice 2060245/2060245B Shaped nozzle for portable minieextruder - Code 2060245/2060245B Buse pour extrudeuse portative - Code 2060245/2060245B
2060255	Vite per minieextruder portatile Portable minieextruder screw Vis pour minieextrudeuse portative
2060256	Resistenza, 220 V / 110 V - 350 W per estrusore portatile Heating element, 220 V / 110 V - 350 W for portable minieextruder Résistance électrique, 220 V / 110 V - 350 W pour extrudeuse portative
2060257	Termostato per estrusore portatile Thermostat for portable minieextruder Thermostat pour extrudeuse portative

- Altre parti di ricambio disponibili su richiesta
- Other spare parts available on request
- Autres pièces de rechange disponibles sur demande



2060250



2060253



2060254



2060255



2060256



2060257

#### Estrusore tubeless per le riparazioni delle forature da chiodi su pneumatici tubeless

#### Tubeless extruder for repairing nail holes on tubeless tyres

#### Extrudeuse tubeless pour les réparations des crevaisons par clous des pneus tubeless

Codice Code Code	Peso Weight Poids	Tensione Power supply Voltage	Temp. di estrusione Extruding temperature Température d'extrusion
2060258	2 kg	220 V / 110 V	0-120 °C



2060258

#### Gomma per estrusore portatile

#### Rubber for portable extruder

#### Caoutchouc pour extrudeuse portative

Codice Code Code	Descrizione Description Description	Rif. Ref. Réf.
2060259	Rotolo di gomma per estrusore portatile (5 kg) per riparazioni a caldo Roll of rubber for portable extruder (5 kg) for hot repairing Rouleau de caoutchouc pour extrudeuse portative (5 kg) pour réparation à chaud	-
2060259B	Rotolo di gomma per estrusore portatile (14 kg) per riparazioni a caldo Roll of tread rubber for extruder (14 kg) for hot repairing Rouleau de caoutchouc pour extrudeuse portative (14 kg) pour réparation à chaud	18-122
2060259C	Rotolo di gomma battistrada per estrusore (14 kg) per riparazioni a caldo Roll of rubber for portable extruder (14 kg) for hot repairing Rouleau de caoutchouc pour chape pour extrudeuse (14 kg) pour réparation à chaud	18-118
2060259E	Corda bianca per estrusore (5 kg) per riparazioni a freddo (usare con 2060259F) White extruder rope (5 kg) for cold repairing (use with 2060259F) Corde blanche pour extrudeuse (5 kg) pour réparation à froid (utiliser avec 2060259F)	18-120
2060259F	Corda nera per estrusore (5 kg) per riparazioni a freddo (usare con 2060259E) Black extruder rope (5 kg) for cold repairing (use with 2060259E) Corde noire pour extrudeuse (5 kg) pour réparation à froid (utiliser avec 2060259E)	18-121



2060259



2060259C



2060259E/F



**Spazzole ottonate**  
**Brass brushes**  
**Brosses cuivrées**

<b>Codice</b> <i>Code</i> <i>Code</i>	<b>Riferimento</b> <i>Reference</i> <i>Référence</i>	<b>Dimensioni</b> <i>Sizes</i> <i>Dimensions</i>	<b>Foro interno</b> <i>Inside hole</i> <i>Forure intérieure</i>	<b>Foro con flange</b> <i>Hole with flanges</i> <i>Forure avec brides</i>	<b>Giri min.</b> <i>R.p.m.</i> <i>Tours min.</i>	<b>Modello</b> <i>Model</i> <i>Modèle</i>
2070260	R 4103	100 x 25	Ø 40	Ø 16	6.000	Lit Kullen
2070261	R 8153	150 x 30	Ø 80	Ø 25	6.000	Lit Kullen
2070261B	R 8154	150 x 35	Ø 77	Ø 25	6.000	Lit Kullen
2070262	R 6154 W	150 x 40	Ø 60	Ø 18,5	6.000	Lit Kullen
2070263	R 8167	160 x 60	Ø 80	Ø 25	6.000	Lit Kullen
2070263B	R 8185	180 x 45	Ø 77	Ø 25	6.000	Lit Kullen
2070263D	R 8204	200 x 40	Ø 77	Ø 25	3.600	Lit Kullen
2070263F	R 10204	200 x 40	Ø 100	Ø 32	3.600	Lit Kullen
2070264	R 10223 B	225 x 35	Ø 100	Ø 32	3.600	Lit Kullen
2070265	R 10236 B	230 x 60	Ø 100	Ø 32	3.600	Lit Kullen



2070271



2070272



2070273

**Spazzole con gambo**  
**Brushes c/w stem**  
**Brosses complètes de tige**

Codice Code Code	Dimensioni Sizes Dimensions	Foro Hole Forure	Giri min. R.p.m. Tours min.
2070271	Ø 40 x 15	Ø 6	15.000
2070272	Ø 50 x 15	Ø 6	15.000
2070273	Ø 60 x 15	Ø 6	15.000



2070277



2070278



2070279

**Spazzole gommate con fili di acciaio**  
**Rubber brushes c/w steel wires**  
**Brosses habillées en caoutchouc avec câbles en acier**

Codice Code Code	Dimensioni Sizes Dimensions	Foro Hole Forure	Giri min. R.p.m. Tours min.
2070277	2" Ø 50 x 6,35	Ø 12,7	15.000
2070278	3" Ø 75 x 6,35	Ø 12,7	15.000
2070279	4" Ø 100 x 12,7	Ø 12,7	8.000
2070280	6" Ø 150 x 25	Ø 50	6.000



2070300



2070301



2070302



2070303

**Spazzole abrasive**  
**Abrasive brushes**  
**Brosses abrasives**

Codice Code Code	Dimensioni Sizes Dimensions	Gambo Stem Tige
2070300	Ø 30 x 20	Ø 6
2070301	Ø 50 x 30	Ø 6
2070302	Ø 40 x 20	Ø 6
2070303	Ø 60 x 30	Ø 6

**MOLE PER METALLO E GOMMA**  
**WHEELS FOR METALLIC AND RUBBER**  
**MEULES POUR MÉTAL ET CAOUTCHOUC**

italmatic



**Mole per metallo - Wheels for metallic - Meules pour métal**

Codice Code Code	Dimensioni Sizes Dimensions	Foro Hole Forure	Gambo Stem Tige	Giri min. R.p.m. Tours min.	Descrizione Description Description
2080285	Ø 75 x 7	Ø 9,53	-	8.390	
2080286	Ø 75 x 7	Ø 16	-	8.390	
2080287	Ø 75 x 15	Ø 16	-	8.390	
2080288	Ø 100 x 16	Ø 16	-	6.300	
2080289	Ø 127 x 16	Ø 16	-	5.040	
2080290	Ø 30 x 6	-	Ø 6	19.700	A disco / Disc / À disque
2080291	Ø 35 x 8	-	Ø 6	18.000	A disco / Disc / À disque
2080292	Ø 20 x 40	-	Ø 6	31.500	Conica / Conical / Conique
2080293	Ø 10 x 30	-	Ø 6	63.000	Conica / Conical / Conique
2080293B	Ø 10 x 30	-	Ø 6	63.000	Conica a miscela rosa / Conical pink compound / Conique mélange rose
2080294	Ø 40 x 30	-	Ø 6	15.670	Cilindrica / Cylindrical / Cylindrique
2080295	Ø 50 x 12	-	Ø 6	12.600	Cilindrica / Cylindrical / Cylindrique

Nota: le mole per metallo sono disponibili su richiesta anche con miscela rosa (più dura)  
 Note: wheels for metallic are available on request also in pink compound (harder)  
 Note: les meules pour métal sont disponibles sur demande aussi en mélange rose (plus dur)



**Mole per gomma - Wheels for rubber - Meules pour caoutchouc**

Codice Code Code	Dimensioni Sizes Dimensions	Foro Hole Forure	Gambo Stem Tige	Giri min. R.p.m. Tours min.	Descrizione Description Description
2080300	Ø 100 x 25	Ø 16	-	6.300	Verde / Green / Verte
2080301	Ø 127 x 25	Ø 16	-	5.040	Verde / Green / Verte
2080302	Ø 100 x 25	Ø 16	-	6.300	Bianca / White / Blanche
2080303	Ø 127 x 25	Ø 16	-	5.040	Bianca / White / Blanche
2080304	Ø 40 x 50	-	Ø 6	15.670	Conica verde / Conical green / Conique verte
2080305	Ø 50 x 18	-	Ø 6	12.600	Cilindrica verde / Cylindrical green / Cylindrique verte
2080306	Ø 35	-	Ø 6	18.000	Sferica verde / Spheric green / Sphérique verte
2080306A	Ø 40	-	Ø 6	4.500	Sferica bianca emulsione ceramica Spheric white ceramic emulsion Sphérique blanche émulsion céramique
2080307	Mola CARBORUNDUM con impugnatura CARBORUNDUM grinding stone with handle Meule CARBORUNDUM avec poignée			mm 150 x 50 x 23 mm 150 x 50 x 23 mm 150 x 50 x 23	

# RULLINI E RASPETTE STITCHERS AND RASPS ROULEAUX ET RÂPES

## Rullini a punte intercambiabili Stitchers with interchangeable pins - Rouleaux à aiguilles interchangeables



Codice Code Code	Dimensioni Sizes Dimensions	Punta Pin Aiguille
2090310	Ø 52 x 12	1,5 x 12 cod. 2010003
2090311	Ø 52 x 18	1,5 x 12 cod. 2010003
2090312	Ø 52 x 27	1,5 x 12 cod. 2010003
2090313	Ø 52 x 46	1,5 x 12 cod. 2010003
2090314	Ø 52 x 76	1,5 x 12 cod. 2010003



## Raspette a punte intercambiabili Rasps with interchangeable pins - Râpes à aiguilles interchangeables

Codice Code Code	Dimensioni Sizes Dimensions	Punta Pin Aiguille	Descrizione Description Description
2090316	Ø 47 x 48	1,5 x 10	Conica / Conical / Conique
2090317	Ø 39		Sferica / Spherical / Sphérique
2090318	Ø 75 x 34	1,5 x 12	Bombata / Convex / Bombée
2090319	Ø 52 x 18	-	Rinforzo in gomma per raspa bombata Rubber reinforcement for convex rasp Renfort en caoutchouc pour râpe bombée



2090316



2090317



2090318



2090319

- Punte per rullini e raspette: vedere pagina 8  
- Nails for rasps and rollers: see page 8  
- Aiguilles pour râpes et rouleaux: voir page 8

## Rullini zigrinati, lisci e da taglio Serrated, smooth and cutting stitchers - Rouleaux crénelés, lisses et à couper



Codice Code Code	Dimensioni Sizes Dimensions	Descrizione Description Description
2090320	Ø 40 x 2,5	Zigrinato / Serrated / Crénelé
2090321	Ø 40 x 10	Zigrinato / Serrated / Crénelé
2090322	Ø 40 x 18	Zigrinato / Serrated / Crénelé
2090323	Ø 40 x 46	Zigrinato / Serrated / Crénelé
2090324	Ø 40 x 76	Zigrinato / Serrated / Crénelé
2090325	Ø 40 x 12	Cilindrico liscio / Smooth cylindrical / Lisse cylindrique
2090326	Ø 40 x 18	Cilindrico liscio / Smooth cylindrical / Lisse cylindrique
2090327	Ø 40 x 46	Cilindrico liscio / Smooth cylindrical / Lisse cylindrique
2090328	Ø 40 x 46	Per scanalature / For grooves / Pour rainures
2090329	Ø 60 x 18	Per talloni / For beads / Pour talons
2090330	Ø 60 x 18	Da taglio / For cutting / À couper



2090326



2090328



2090329



2090330



2100330



2100331

2100331D



2100332



2100333

**Smerigliatrici professionali ad alte prestazioni URYU**  
**Professional grinders high performances URYU**  
**Ponceuses professionnelles à hautes performances URYU**

Codice Code Code	Modello Model Modèle	Giri min R.p.m. Tours min.	Peso kg Weight kg Poids kg	Watt Watt Watt	Consumo aria L/Min. Air consumption L/min. Consommation air L/min.	Attacco aria Air connection Connexion air	db db db	Utilizzo Utilization Utilisation
2100330	UG 38 NA	25.000	0,65	315	400	1/4"	75	Pneum. vettura / Car tyres / Pneus tourisme
2100331	UG 65 EBR	14.600	1,5	412	600	1/4"	95	Pneum. vettura / Car tyres / Pneus tourisme
2100332	UG 125 OL	7.200	3,2	750	900	1/4"	88	Pneum. giganti / Truck tyres / Pneus camion
2100333	UD 50S 45	5.000	0,85	0,18	400	1/4"	77	Pneum. vettura / Car tyres / Pneus tourisme

**2100331D** Scarico aria silenziatore per cod. 2100331 / Silencing air release for code 2100331 / Purge air silencieuse pour code 2100331

Nota: per smerigliatrici a 4.000 e 22.000 giri/min. vedere codici 3060896G e 3070108S

Note: for grinders at 4.000 and 22.000 r.p.m. see codes 3060896G and 3070108S

Note: pour ponceuses de 4.000 et 22.000 tours/min. voir les codes 3060896G et 3070108S

**Optionals e parti di ricambio**  
**Optionals and spare parts**  
**Options et pièces de rechange**

Codice Code Code	Descrizione Description Description
2100343	Pinza per smerigliatrice UG 65 EBR mm 6 Pliers for grinder UG 65 EBR mm 6 Pincès pour ponceuse UG 65 EBR mm 6
2100344	Pinza per smerigliatrice UG 65 EBR mm 8 Pliers for grinder UG 65 EBR mm 8 Pincès pour ponceuse UG 65 EBR mm 8
2100345	Mandrino autobloccante 0-8mm attacco 3/8" 24UNF Self-locking chuck 0-8mm connection 3/8" 24UNF Mandrin à blocage automatique 0- mm connexion 3/8" 24UNF
2100346	Mandrino a cremagliera 0-8mm attacco 3/8" 24UNF Rack chuck 0-8mm connection 3/8" 24UNF Mandrin à crémaillère 0-8mm connexion 3/8" 24UNF



2100343



2100345



2100344



2100346



**ACCESSORI DA TAGLIO**  
**TOOLS FOR CUTTING**  
**ACCESSOIRES À COUPER**



2110350



2110353



2110352



2110354

**Accessori da taglio**  
**Tools for cutting**  
**Accessories à couper**

<b>Codice</b> <i>Code</i> <i>Code</i>	<b>Descrizione</b> <i>Description</i> <i>Description</i>
<b>2110350</b>	Coltello speciale per gomma tipo scimitarra da 9" <i>Bail cutting knife for rubber 9"</i> <i>Couteau spécial pour caoutchouc type cimenterre de 9"</i>
<b>2110351</b>	Coltello speciale per gomma tipo scimitarra da 12" <i>Bail cutting knife for rubber 12"</i> <i>Couteau spécial pour caoutchouc type cimenterre de 12"</i>
<b>2110352</b>	Coltello speciale tipo trincetto O.T. <i>Special knife type O.T.</i> <i>Couteau spécial type tranchet O.T.</i>
<b>2110353</b>	Acciarino affila coltelli <i>Sharpener for knives</i> <i>Affûteuse pour couteaux</i>
<b>2110354</b>	Pietra speciale affila coltelli <i>Special stone for knives sharpening</i> <i>Pierre spéciale pour affûter les couteaux</i>
<b>2110355</b>	Coltello taglia bave a una via <i>Trimming knife - one way</i> <i>Couteau à couper les bavures à une voie</i>
<b>2110356</b>	Taglierino rigido con lama retrattile <i>Stiff cutter with retractable blade</i> <i>Coupoir rigide avec lame rétractile</i>
<b>2110357</b>	Lama di ricambio diritta per taglierino rigido. Scatola da 10 pz. <i>Straight spare blade for stiff cutter. Box of 10 pcs.</i> <i>Lame de rechange droite pour coupoir rigide. Boîte à 10 pcs.</i>
<b>2110358</b>	Forbice speciale per gomma da 8" <i>Shears for rubber 8"</i> <i>Ciseaux spéciaux pour caoutchouc de 8"</i>
<b>2110360</b>	Forbice speciale per gomma da 10" <i>Shears for rubber 10"</i> <i>Ciseaux spéciaux pour caoutchouc de 10"</i>
<b>2110361</b>	Seghetto circolare per crateri Ø 6x220 <i>Tyre hole reamer Ø 6x220</i> <i>Scie passe-partout circulaire pour cratères Ø 6x220</i>
<b>2110362</b>	Seghetto circolare Ø 6x100x6 <i>Serrated hole reamer Ø 6x100x6</i> <i>Scie passe-partout circulaire Ø 6x100x6</i>
<b>2110363</b>	Tronchesino per fili acciaio da 7 1/2" <i>Steel wire cutting nippers 7 1/2"</i> <i>Tricoises pour fils en acier de 7 1/2"</i>
<b>2110364</b>	Punteruolo a punta conica <i>Picking awl with conical nail</i> <i>Poinçon à pointe conique</i>
<b>2110368</b>	Scalda coltello con termostato regolabile <i>Knife heater with adjustable thermostat</i> <i>Réchauffeur pour couteaux avec thermostat réglable</i>



2110355



2110356



2110357



2110360



2110361



2110362



2110363



2110364



2110368

**PORTALAMETTE E LAMETTE**  
**TYRE TRIMMING TOOLS AND TRIMMING BLADES**  
**PORTE-LAMES ET LAMES À ÉBARBER**

italmatic



**Portalamette - Tyre trimming tools - Porte-lames à ébarber**

Codice Code Code	Modello Model Modèle	Utilizzo Utilization Utilisation
2120370	Curvo con appoggio regolabile Curved with adjustable support Courbe avec appui réglable	Pneumatici vettura Car tyres Pneus tourisme
2120371	Piatto normale Flat normal Normal plat	Pneumatici vettura Car tyres Pneus tourisme
2120372	Curvo con appoggio regolabile Curved with adjustable support Courbe avec appui réglable	Pneumatici autocarro Truck tyres Pneus camion
2120372B	Speciale ricurvo per lame 2120378B, per raggiungere zone difficili e strette Special curved for blades 2120378B, to reach difficult and narrow areas Spécial courbe pour lames 2120378B, pour joindre des zones difficiles et étroites	Pneumatici autocarro Truck tyres Pneus camion
2120373	Piatto normale Flat normal Normal plat	Pneumatici autocarro Truck tyres Pneus camion

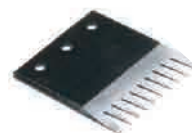

2120374



2120375



2120376



2120377

**Lamette - Trimming blades - Lames à ébarber**

Codice Code Code	Nr. denti Nr. of teeth Nr. de dents	Descrizione Description Description	Utilizzo Utilization Utilisation
2120374	10	49 x 52	Vettura / Car / Tourisme
2120375	10	49 x 52 doppia curvata double curved double courbe	Vettura / Car / Tourisme
2120376	8	49 x 52	Autocarro / Truck / Camion
2120377	15	75 x 75	Autocarro / Truck / Camion
2120378	15	75 x 75 curvata curved courbe	Autocarro / Truck / Camion
2120378B	5	51 x 25 curvata curved courbe	Autocarro / Truck / Camion

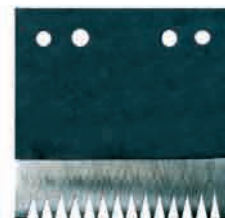

2120378



2120378B

**ACCESSORI E RICAMBI VARI**  
**ACCESSORIES AND SPARE PARTS**  
**ACCESSOIRES ET PIÈCES DE RECHANGE**

**Pistole - Guns - Pistolets**

Codice Code Code	Descrizione Description Description
2130380	Pistola spruzzapara "AZZ 1,8" Para rubber gun "AZZ 1,8" Pistolet pour caoutchouc "AZZ 1,8"
2130381	Pistola soffiaggio "AZZ" Blowing gun "AZZ" Pistolet de soufflage "AZZ"
2130382	Pistola per Italmatic Matic Airless codice 101105 Gun for Italmatic Matic Airless code 101105 Pistolet pour Matic Airless Italmatic code 101105

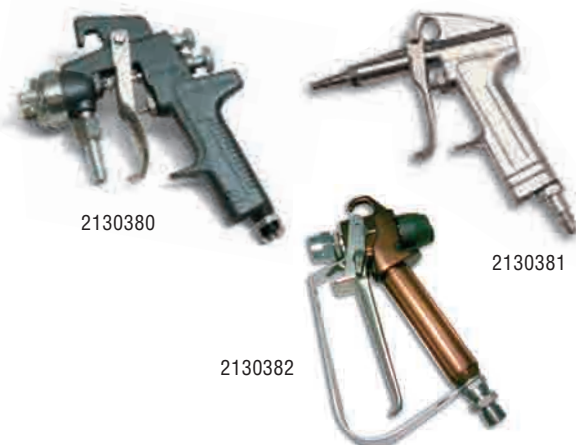

**Tubi speciali flessibili - Special flexible hoses - Tuyaux spéciaux flexibles**

Codice Code Code	Diametro interno Inside diameter Diamètre intérieur
2130384	Ø 70
2130385	Ø 80
2130386	Ø 90
2130387	Ø 100
2130388	Ø 110
2130389	Ø 120
2130390	Ø 130
2130391	Ø 150



2130386

**Tubi in gomma - Rubber hoses - Tuyaux en caoutchouc**

Codice Code Code	Modello Model Modèle	Misura Size Dimension	Tipo Type Type
2130392	Tubo aria normale per gonfiaggio camere di cottura per presse Normal air hose for curing tubes inflation or presses Tuyau air normal pour gonflage chambres de cuisson pour presses	Ø 6 x 14	ISEO 20
2130392A	Tubo aria normale per gonfiaggio camere di cottura per presse Normal air hose for curing tubes inflation for presses Tuyau air normal pour gonflage chambres de cuisson pour presses	Ø 8 x 17	ISEO 20
2130393	Tubo aria corazzato per gonfiaggio camere di cottura per presse Armored air hose for curing tubes inflation for presses Tuyau air cuirassé pour gonflage chambres de cuisson pour presses	Ø 8 x 17	SAE 100 R2



2130393

**Accessori per tubi in gomma**  
**Accessories for rubber hoses - Accessoires pour tuyaux en caoutchouc**

Codice Code Code	Descrizione Description Description
2130395	Attacco rapido aria 1 / 4" Air quick connector 1 / 4" - Connecteur rapide air 1 / 4"
2130396	Nipple aria tipo "L" - 1 / 4" Air "L" nipple - 1 / 4" - Nipple air à "L" 1 / 4"
2130397	Portagomma da 17 mm Rubber support 17 mm - Support du caoutchouc 17 mm
2130398	Prolunga a vite tipo "L" da mm 8 Screw extension type "L" 8 mm - Rallonge à vis type "L" 8 mm



**Tubi teflon**  
**Teflon hoses**  
**Tuyaux en teflon**

Codice Code Code	Descrizione Description Description	Tipo Type Type	Misura Size Dimension	Lunghezza Length Longueur
2130400	Per presse completo di raccordo maschio o femmina <i>For presses c/w male or female coupler</i> <i>Pour presses complet de raccord mâle ou femelle</i>	W3	1 / 4"	on req.
2130401	Per presse completo di raccordo maschio o femmina <i>For presses c/w male or female coupler</i> <i>Pour presses complet de raccord mâle ou femelle</i>	W4	3 / 8"	on req.
2130402	Per presse completo di raccordo maschio o femmina <i>For presses c/w male or female coupler</i> <i>Pour presses complet de raccord mâle ou femelle</i>	W6	1 / 2"	on req.
2130403A	Per autoclave / <i>For autoclave / Pour autoclave</i>	-	1 / 4"	1200 mm
2130403B	Per autoclave / <i>For autoclave / Pour autoclave</i>	-	1 / 4"	1400 mm
2130403C	Per autoclave / <i>For autoclave / Pour autoclave</i>	-	1 / 4"	1600 mm
2130403D	Per autoclave / <i>For autoclave / Pour autoclave</i>	-	1 / 4"	2000 mm
2130403E	Per autoclave / <i>For autoclave / Pour autoclave</i>	-	1 / 4"	2400 mm
2130403F	Per autoclave / <i>For autoclave / Pour autoclave</i>	-	1 / 4"	2800 mm



2130400

**Serie valvole per camere di cottura per pressa**  
**Valves kit for curing tubes for press**  
**Série de valves pour chambres de cuisson pour presse**

Codice Code Code	Descrizione Description Description
2130404	Valvola in ottone tipo B diam. 12/8 speciale per U-Tubes <i>Brass valve type B 12/8 special for U-Tubes</i> <i>Valve en laiton type B diam. 12/8 spéciale pour U-Tubes</i>
2130404A	Valvola in ottone tipo A 1/4" <i>Brass valve type A 1/4"</i> <i>Valve en laiton type A 1/4"</i>
2130404E	Piastrella grande per camere di cottura <i>Large protection diaphragm for curing tubes</i> <i>Protection grande pour chambres de cuisson</i>
2130404F	Piastrella piccola per camere di cottura <i>Small protection diaphragm for curing tubes</i> <i>Protection petite pour chambres de cuisson</i>



2130404



2130404A



2130404E



2130404F

**Valvole per camere di cottura in autoclave**  
**Valves for curing tubes in autoclave**  
**Valves pour chambres de cuisson en autoclave**

Codice Code Code	Descrizione Description Description	Misura Size Dimension
2130404M	Attacco aria per camere per autoclavi <i>Air connector for tubes for autoclaves</i> <i>Connecteur air pour chambres pour autoclaves</i>	1 / 4"
2130404N	Nipple aria per camere per autoclavi <i>Air nipple for tubes for autoclaves</i> <i>Nipple air pour chambres pour autoclaves</i>	1 / 4"



2130404M



2130404N



- Vengono combinati con articoli codice 2130404A e codice 2130404E o 2130404F.  
 - They are combined with items code 2130404A and code 2130404E or 2130404F.  
 - Ils sont combinés avec les articles code 2130404A et code 2130404E ou 2130404F.

**Kit valvole per envelopes per autoclavi**  
**Valves kit for envelopes for autoclaves**  
**Kit de valves pour envelopes pour autoclaves**

**Kit 1**

 2130404P	
<b>Codice</b> <i>Code</i> <b>2130404P</b>	<b>Descrizione</b> <i>Description</i> Valvola envelope tipo "1" <i>Valve for envelope type "1"</i> <i>Valve pour envelope type "1"</i>
 2130404R	
<b>Codice</b> <i>Code</i> <b>2130404R</b>	<b>Descrizione</b> <i>Description</i> Riduttore 5/16" femmina 1/4" maschio <i>Reducer 5/16" female 1/4" male</i> <i>Reducteur 5/16" femelle 1/4" mâle</i>
 2130404T	
<b>Codice</b> <i>Code</i> <b>2130404T</b>	<b>Descrizione</b> <i>Description</i> Nipple aria per envelopes per autoclavi <i>Air nipple for envelopes for autoclaves</i> <i>Nipple air pour envelopes pour autoclaves</i>
 2130404U	
<b>Codice</b> <i>Code</i> <b>2130404U</b>	<b>Descrizione</b> <i>Description</i> Attacco aria per envelopes per autoclavi <i>Air connector for envelopes for autoclaves</i> <i>Connecteur air pour envelopes pour autoclaves</i>

**Kit 2**

 2130404Q	
<b>Codice</b> <i>Code</i> <b>2130404Q</b>	<b>Descrizione</b> <i>Description</i> Valvola envelope tipo "2" - Filetto 482-26 <i>Valve for envelope type "2" - Tread 482-26</i> <i>Valve pour envelope type "2" - Fil 482-26</i>
 2130404S	
<b>Codice</b> <i>Code</i> <b>2130404S</b>	<b>Descrizione</b> <i>Description</i> Riduttore 482 - 26 - R 1/4" <i>Reducer 482 - 26 - R 1/4"</i> <i>Réducteur 482 - 26 - R 1/4"</i>
 2130404T	
<b>Codice</b> <i>Code</i> <b>2130404T</b>	<b>Descrizione</b> <i>Description</i> Nipple aria per envelopes per autoclavi <i>Air nipple for envelopes for autoclaves</i> <i>Nipple air pour envelopes pour autoclaves</i>
 2130404U	
<b>Codice</b> <i>Code</i> <b>2130404U</b>	<b>Descrizione</b> <i>Description</i> Attacco aria per envelopes per autoclavi <i>Air connector for envelopes for autoclaves</i> <i>Connecteur air pour envelopes pour autoclaves</i>

**Attacchi - Connectors - Connecteurs**

<b>Codice</b> <i>Code</i> <i>Code</i>	<b>Modello</b> <i>Model</i> <i>Modèle</i>
<b>2130405</b>	Attacco vapore femmina da 1/2" in ottone <i>Brass female steam connector 1/2"</i> <i>Connecteur vapeur femelle 1/2" en laiton</i>
<b>2130406</b>	Attacco aria 1 canale da 1/4" femmina <i>One way air connector - 1/4" female</i> <i>Connecteur air à 1 voie - 1/4" femelle</i>
<b>2130408</b>	Attacco rapido aria tipo "L" da 3/8" femmina <i>Air quick connector type "L" 3/8" female</i> <i>Connecteur rapide air type "L" 3/8" femelle</i>
<b>2130409</b>	Attacco rapido aria da 1/4" tipo RTS <i>Air quick connector 1/4" type RTS</i> <i>Connecteur rapide air 1/4" type RTS</i>
<b>2130410</b>	Portagomma da 23 mm <i>Rubber support 23 mm / Support du caoutchouc 23 mm</i>



2130405



2130406



2130408



2130410

**Attacchi - Connectors - Connecteurs**

<b>Codice</b> <i>Code</i> <i>Code</i>	<b>Modello</b> <i>Model</i> <i>Modèle</i>
<b>2130411</b>	Nipple vapore maschio in ottone da 1/2" <i>Brass steam male nipple 1/2"</i> <i>Nipple vapeur mâle 1/2" en laiton</i>
<b>2130412</b>	Nipple vapore femmina in ottone da 1/2" <i>Brass steam female nipple 1/2"</i> <i>Nipple vapeur femelle 1/2" en laiton</i>
<b>2130413</b>	Nipple aria tipo "L" 3/8" maschio <i>Air "L" nipple - 3/8" male</i> <i>Nipple air à "L" - 3/8" mâle</i>
<b>2130414</b>	Nipple aria tipo "L" 1/4" femmina <i>Air "L" nipple - 1/4" female</i> <i>Nipple air à "L" - 1/4" femelle</i>
<b>2130415</b>	Nipple aria tipo RTS da 1/4" femmina <i>Air nipple type RTS - 1/4" female</i> <i>Nipple air type RTS 1/4" femelle</i>
<b>2130416</b>	Nipple aria in ottone 1 canale da 1/4" <i>One way brass air nipple - 1/4"</i> <i>Nipple air en laiton à 1 voie - 1/4"</i>
<b>2130417</b>	Nipple aria in ottone 1 canale filetto valvola <i>One way brass air nipple - valve thread</i> <i>Nipple air en laiton à 1 voie - filet valve</i>
<b>2130418</b>	Nipple aria in ottone da 1/4" codulo per tubo diam. 8 mm <i>Brass air nipple 1/4" spigot for tube diam. 8 mm</i> <i>Nipple air en laiton 1/4" queue pour tube diam. 8 mm</i>



2130411



2130412



2130413



2130416



2130417



2130418

**Raccordi - Couplers - Raccords**

<b>Codice</b> <i>Code</i> <i>Code</i>	<b>Modello</b> <i>Model</i> <i>Modèle</i>
<b>2130420</b>	Prolunga a vite in ottone tipo "L" da mm 12 per attacco 3/8" <i>Brass screw extension type "L" 12 mm for connector 3/8"</i> <i>Rallonge à vis en laiton type "L" 12 mm pour connecteur 3/8"</i>
<b>2130421</b>	Raccordo maschio da 1/4" codulo a vite 7 mm <i>Male coupler 1/4" screw spigot 7 mm</i> <i>Raccord mâle 1/4" queue à vis 7 mm</i>



2130420



2130421

**Guarnizioni**  
**Gaskets**  
**Joints**

<b>Codice</b> <i>Code</i> <i>Code</i>	<b>Modello</b> <i>Model</i> <i>Modèle</i>
<b>2130424</b>	Guarnizione da 1/2" per attacco vapore nera <i>Black gasket 1/2" for steam connector</i> <i>Joint noir 1/2" pour connecteur vapeur</i>
<b>2130425</b>	Guarnizione aria tipo "A" al silicone <i>Air silicone gasket type "A"</i> <i>Joint à la silicone air type "A"</i>
<b>2130426</b>	Guarnizione aria tipo "A" nera <i>Black air gasket type "A"</i> <i>Joint air noir type "A"</i>
<b>2130427</b>	Guarnizione aria tipo "B" al silicone <i>Air silicone gasket type "B"</i> <i>Joint à la silicone air type "B"</i>
<b>2130428</b>	Guarnizione aria tipo "B" nera <i>Black air gasket type "B"</i> <i>Joint air noir type "B"</i>
<b>2130429</b>	Guarnizione aria tipo "L" da 1/4" <i>Air gasket type "L" 1/4"</i> <i>Joint air type "L" 1/4"</i>
<b>2130430</b>	Guarnizione aria tipo "L" da 3/8" <i>Air gasket type "L" 3/8"</i> <i>Joint air type "L" 3/8"</i>



2130424



2130425



2130426



2130427



2130428



2130429

**Rubinetti**  
**Taps**  
**Robinets**

<b>Codice</b> <i>Code</i> <i>Code</i>	<b>Modello</b> <i>Model</i> <i>Modèle</i>	<b>Filettatura interna</b> <i>Inside thread</i> <i>Filet intérieure</i>
<b>2130432</b>	Rubinetto a sfera <i>Ball tap / Robinet à billes</i>	Ø 1/4"
<b>2130433</b>	Rubinetto a sfera <i>Ball tap / Robinet à billes</i>	Ø 3/8"
<b>2130434</b>	Rubinetto a sfera <i>Ball tap / Robinet à billes</i>	Ø 1/2"
<b>2130435</b>	Rubinetto a sfera <i>Ball tap / Robinet à billes</i>	Ø 3/4"
<b>2130436</b>	Rubinetto a sfera <i>Ball tap / Robinet à billes</i>	Ø 1"



2130434



2130432

**Calibri**  
**Gauges**  
**Calibres**

<b>Codice</b> <i>Code</i> <i>Code</i>	<b>Modello</b> <i>Model</i> <i>Modèle</i>
<b>2130440</b>	Calibro digitale mm 150 <i>Digital gauge mm 150</i> <i>Calibre digital mm 150</i>
<b>2130440B</b>	Calibro meccanico mm 150 <i>Mechanical gauge mm 150</i> <i>Calibre mécanique mm 150</i>



2130440



2130440B

**Metri decimali**  
**Decimal meters**  
**Mètres décimaux**

Codice Code Code	Lunghezza in metri Length in meters Longueur en mètres	Materiale Material Matériel
2130441	5	Fibra di vetro / Fiber glass / Fibre de verre
2130442	10	Fibra di vetro / Fiber glass / Fibre de verre
2130443	10	Acciaio rivestito in nylon Nylon coated steel Acier habillé en nylon
2130446	20	Acciaio smaltato / Enameled steel / Acier émaillé



2130442



2130446

**Termometri**  
**Thermometers**  
**Thermomètres**

Codice Code Code	Modello Model Modèle	Scala Scale Echelle
2130447	Termometro con microprocessore a tenuta stagna - precisione $\pm 0,5^{\circ}\text{C}$ completo di termocoppia per superfici Thermometer c/w microprocessor with water seal - precision $\pm 0,5^{\circ}\text{C}$ c/w thermocouple for surfaces Thermomètre avec microprocesseur à étanche d'eau - précision $\pm 0,5^{\circ}\text{C}$ complet de thermocouple pour surfaces	- 50°C + 850°C
2130448	Sonda termocoppia per superfici per codice 2130447 Thermocouple probe for surfaces for code 2130447 Sonde thermocouple pour surfaces pour code 2130447	
2130448C	Termometro ad infrarossi Infra-red rays thermometer Thermomètre rayons infrarouges	- 50°C + 750°C



2130447



2130448C



2130448

**Durometro per gomma**  
**Hardness measuring device for rubber**  
**Mesureur de dureté pour caoutchouc**

Codice Code Code	Shores - A Shores - A Shores - A	Custodia Sheath Étui
2130449	0 ÷ 100	Legno / Wood / Bois



2130449





2130450



2130451D

**Marcatore elettrico**  
**Electric marker**  
**Dispositif électrique pour marquer**

<b>Codice</b> <i>Code</i> <i>Code</i>	<b>Descrizione</b> <i>Description</i> <i>Description</i>
<b>2130450</b>	Marcatore elettrico volt 220 - 300 W completo di compositoio 70x30mm <i>Electric marker volt 220 - 300 W complete with composing stick 70x30mm</i> <i>Dispositif électrique pour marquer volt 220 - 300 W avec composteur 70x30mm</i>
<b>2130451</b>	Stampo in ottone con diciture fisse <i>Brass mould with fix engravings</i> <i>Moule en laiton avec gravures fixes</i>
<b>2130451B</b>	Stampo in ottone per marcatore con logo aziendale <i>Brass mould for marker with company's logo</i> <i>Moule en laiton pour dispositif électrique pour marquer avec logo de la société</i>
<b>2130451D</b>	Carattere alfanumerico per marcatore <i>Alpha-numerical type for marker</i> <i>Caractère alpha-numérique pour dispositif électrique pour marquer</i>
<b>2130452</b>	Set resistenza per marcatore (2 elementi da 150W/cad.) completi di isolamento <i>Set heating element for marker (2 elements of 150W/each) complete with insulation</i> <i>Set résistance pour dispositif pour marquer (2 éléments de 150W/chacun) complet d'isolation</i>
<b>2130452B</b>	Set di isolanti <i>Set of insulating plates</i> <i>Jeu de plaques isolantes</i>
<b>2130452D</b>	Spessori <i>Shims</i> <i>Épaisseurs</i>
<b>2130453</b>	Smarcatore completo di lama <i>Erasing device complete with blade</i> <i>Outil defaceur complet de lame</i>
<b>2130454</b>	Lama di ricambio <i>Spare blade</i> <i>Lame de rechange</i>



2130452

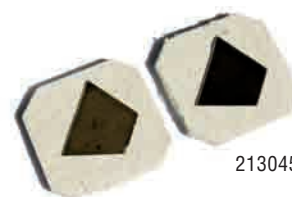

2130452B



2130452D



2130453

**Fasce in gomma nera Italmatic per mandrini a 8 settori standard**  
**Italmatic black rubber bands for standard chucks in 8 segments**  
**Bandes en caoutchouc noir Italmatic pour mandrins standard en 8 secteurs**

<b>Codice</b> <i>Code</i> <i>Code</i>	<b>Dimensioni</b> <i>Sizes</i> <i>Dimensions</i>	<b>Tipo mandrino</b> <i>Type of chuck</i> <i>Type de mandrin</i>
<b>2130455</b>	10" x 147	10/12" x 140
<b>2130456</b>	12-14" x 147	12/14" x 140
<b>2130457</b>	13-15" x 187	13/15" x 180
<b>2130458</b>	14-16" x 147	14/16" x 140
<b>2130458S</b>	16-18" x 203	16/18" x 190
<b>2130459</b>	17,5-19,5" x 228	17,5-19,5" x 220
<b>2130460</b>	19,5-22,5" x 228	19,5-22,5" x 220
<b>2130461</b>	22,5-24,5" x 262	22,5-24,5" x 250
<b>2130462</b>	Attrezzo per il montaggio fasce mandrino Tool to mount chuck rubber bands Outil pour le montage des bandes en caoutchouc pour mandrin	

- Su richiesta, fasce di qualsiasi tipo
- Upon request, rubber bands of any size
- Sur demande, bandes en caoutchouc de toutes dimensions

**Silicone per presse**  
**Silicone for presses**  
**Silicone pour presses**

<b>Codice</b> <i>Code</i> <i>Code</i>	<b>Descrizione</b> <i>Description</i> <i>Description</i>
<b>2130463</b>	Silicone spray <i>Spray silicone</i> <i>Silicone en vaporisateur</i>
<b>2130464</b>	Silicone in tanica da 25 kg <i>Silicone in drum of 25 kg</i> <i>Silicone en fut à 25 kg</i>
<b>2130464A</b>	Silicone in tanica da 50 kg <i>Silicone in drum of 50 kg</i> <i>Silicone en fut à 50 kg</i>
<b>2130465</b>	Silicone liquido concentrato - contenitore kg 60 <i>Concentrated liquid silicone - container capacity 60 kg</i> <i>Silicone liquide concentrée - récipient à 60 kg</i>
<b>2130466</b>	Nebulizzatore per silicone con serbatoio carrellato da 24 lt completo di accessori <i>Nebulizer for silicone with tank on trolley capacity 24 lt complete with accessories</i> <i>Atomiseur pour silicone avec réservoir sur chariot capacité 24 lt complet d'accessoires</i>
<b>2130466A</b>	Nebulizzatore in acciaio inox per silicone con serbatoio carrellato da 24lt completo di accessori <i>Stainless steel nebulizer for silicone with tank on trolley capacity 24lt complete with accessories</i> <i>Atomiseur inox pour silicone avec reservoir sur chariot capacité 24lt complet d'accessoires</i>
<b>2130467</b>	Lancia speciale spruzza silicone per codice 2130466 <i>Special nozzle for silicone spraying for code 2130466</i> <i>Lance spéciale pour vaporiser la silicone pour code 2130466</i>
<b>2130467A</b>	Lancia speciale inox spruzza silicone per codice 2130466A <i>Special stainless steel nozzle for silicone spraying for code 2130466A</i> <i>Lance spéciale inox pour vaporiser la silicone pour code 2130466A</i>



2130456



2130462



2130463



2130465



2130466



2130475A

**Guarnizioni per autoclavi**  
**Seals for autoclaves**  
**Joints pour autoclaves**

<b>Codice</b> <i>Code</i> <i>Code</i>	<b>Descrizione</b> <i>Description</i> <i>Description</i>	<b>Spessore</b> <i>Thickness</i> <i>Épaisseur</i>	<b>Tipo autoclave</b> <i>Autoclave model</i> <i>Modèle autoclave</i>
2130470B	Guarnizione anello chiuso / <i>Closed ring seal</i> / <i>Joint à anneau fermé</i>	15 mm	AI Ø 1000
2130470D	Guarnizione anello chiuso / <i>Closed ring seal</i> / <i>Joint à anneau fermé</i>	13 mm	AI Ø 1000
2130470F	Guarnizione anello chiuso / <i>Closed ring seal</i> / <i>Joint à anneau fermé</i>	15 mm	AI Ø 1050
2130470H	Guarnizione anello chiuso doppio labbro <i>Closed ring seal with double lip</i> / <i>Joint à anneau fermé à double lèvre</i>	15 mm	AI Ø 1050
2130470K	Guarnizione anello chiuso / <i>Closed ring seal</i> / <i>Joint à anneau fermé</i>	15 mm	AI Ø 1300
2130471B	Guarnizione anello chiuso / <i>Closed ring seal</i> / <i>Joint à anneau fermé</i>	15 mm	AI Ø 1500
2130471D	Guarnizione anello chiuso / <i>Closed ring seal</i> / <i>Joint à anneau fermé</i>	13 mm	AI Ø 1500
2130472B	Guarnizione anello chiuso / <i>Closed ring seal</i> / <i>Joint à anneau fermé</i>	15 mm	AI Ø 1700
2130472C	Guarnizione anello chiuso doppio labbro / <i>Closed ring seal with double lip</i> / <i>Joint à anneau fermé à double lèvre</i>	15 mm	AI Ø 1700
2130472D	Guarnizione anello chiuso / <i>Closed ring seal</i> / <i>Joint à anneau fermé</i>	15 mm	AI Ø 2100
2130472F	Guarnizione anello chiuso doppio labbro <i>Closed ring seal with double lip</i> / <i>Joint à anneau fermé à double lèvre</i>	15 mm	AI Ø 2100
2130472H	Guarnizione anello chiuso doppio labbro <i>Closed ring seal with double lip</i> / <i>Joint à anneau fermé à double lèvre</i>	17 mm	AI Ø 2100
2130472K	Guarnizione anello chiuso / <i>Closed ring seal</i> / <i>Joint à anneau fermé</i>	15 mm	AI Ø 2300
2130472N	Guarnizione anello chiuso / <i>Closed ring seal</i> / <i>Joint à anneau fermé</i>	15 mm	AI Ø 2600
2130472Q	Guarnizione anello chiuso doppio labbro <i>Closed ring seal with double lip</i> / <i>Joint à anneau fermé à double lèvre</i>	15 mm	AI Ø 2600
2130472S	Guarnizione anello chiuso / <i>Closed ring seal</i> / <i>Joint à anneau fermé</i>	15 mm	AI Ø 2800
2130473B	Guarnizione anello chiuso / <i>Closed ring seal</i> / <i>Joint à anneau fermé</i>	15 mm	AI Ø 3000
2130473D	Guarnizione anello chiuso doppio labbro <i>Closed ring seal with double lip</i> / <i>Joint à anneau fermé à double lèvre</i>	15 mm	AI Ø 3000
2130473F	Guarnizione anello chiuso / <i>Closed ring seal</i> / <i>Joint à anneau fermé</i>	15 mm	AI Ø 3300
2130473H	Guarnizione anello chiuso profilo speciale <i>Closed ring seal special profile</i> / <i>Joint à anneau fermé profil spécial</i>	–	AI Ø 3800
2130473K	Guarnizione anello chiuso profilo speciale <i>Closed ring seal special profile</i> / <i>Joint à anneau fermé profil spécial</i>	–	AI Ø 4200
2130474A	Rotolo da 20 m <i>Roll of 20 m</i> / <i>Rouleau à 20 m</i>	15 mm	AI Ø 3300-3000 2600-2100-1050
2130474C	Rotolo da 20 m doppio labbro <i>Roll of 20 m with double lip</i> / <i>Rouleau à 20 m à double lèvre</i>	15 mm	AI Ø 3300-3000 2600-2100-1050
2130474E	Rotolo da 20 m / <i>Roll of 20 m</i> / <i>Rouleau à 20 m</i>	13 mm	AI Ø 1000-1500
2130474G	Rotolo da 20 m doppio labbro <i>Roll of 20 m with double lip</i> / <i>Rouleau à 20 m à double lèvre</i>	17 mm	AI Ø 2100
2130474J	Rotolo da 25 m profilo speciale <i>Roll of 25 m special profile</i> / <i>Rouleau à 25 m profil spécial</i>	–	AI Ø 3800
2130474M	Rotolo da 27 m profilo speciale <i>Roll of 27 m special profile</i> / <i>Rouleau à 27 m profil spécial</i>	–	AI Ø 4200



2130475C



2130475G



2130475H



2130475K

**Altri accessori autoclavi e cilindri**  
**Other accessories for autoclaves and rollers**  
**Autres accessoires pour autoclaves et cylindres**

<b>Codice</b> <i>Code</i> <i>Code</i>	<b>Descrizione</b> <i>Description</i> <i>Description</i>
<b>2130475C</b>	Colla al silicone in tubetto da g 100 per incollare le estremità della guarnizione <i>Silicone glue in g 100 tube for sticking together the gasket ends</i> <i>Colle à la silicone en tube de 100 g pour agglutiner les extrémités du joint</i>
<b>2130475E</b>	Grasso per lubrificazione cuscinetti motori pressurizzati, kg 1 <i>Grease for pressurized motor bearings lubrication, kg 1</i> <i>Graisse pour lubrifier les roulements des moteurs pressurisés, kg 1</i>
<b>2130475F</b>	Grasso per lubrificazione denti rotazione porta, kg 1 <i>Grease for door rotation teeth lubrication, kg 1</i> <i>Graisse pour lubrifier les dents rotation porte, kg 1</i>
<b>2130475G</b>	Grasso per lubrificazione delle guarnizioni kg 1 <i>Grease for gaskets lubrication kg 1</i> <i>Graisse pour lubrifier les joints kg 1</i>
<b>2130475H</b>	Pennini per registratore (colori disponibili: rosso/blu/verde) <i>Pens for recorder (available colours: red/blue/green)</i> <i>Petits stylos pour enregistreur (couleurs disponibles: rouge/bleu/vert)</i>
<b>2130475K</b>	Set carta per registratore a display 100 mm x 30 m <i>Paper set for display recorder 100 mm x 30 m</i> <i>Jeu de papier pour enregistreur avec display 100 mm x 30 m</i>
<b>2130475L</b>	Diagrammi per registratore (confezione 100 pz.) - circolare <i>Diagrams for recorder (box of 100 pcs.) - round</i> <i>Diagrammes pour enregistreur (conditionnement à 100 pcs.) - ronds</i>
<b>2130475M</b>	Vernice antiruggine speciale per autoclavi alluminio alta temperatura - contenitore 5 lt <i>Rustproof special paint for high temperature aluminium autoclaves - container 5 lt</i> <i>Peinture antirouille spéciale pour autoclaves aluminium hautes températures - récipient 5 lt</i>
<b>2130475S</b>	Film per rivestimento cilindri in nylon trasparente <i>Nylon transparent film for rollers wrapping</i> <i>Film de nylon transparent pour habillage cylindres</i>
<b>2130475T</b>	Benda per rivestimento cilindri in tessuto di nylon 70 mm - 1 metro <i>Nylon tissue wrapping tape for rollers 70 mm - 1 meter</i> <i>Bandage de tissu de nylon pour habillage cylindres 70 mm - 1 mètre</i>
<b>2130475TW</b>	Benda per rivestimento cilindri in tessuto di nylon 120 mm - 1 metro <i>Nylon tissue wrapping tape for rollers 120 mm - 1 meter</i> <i>Bandage de tissu de nylon pour habillage cylindres 120 mm - 1 mètre</i>
<b>2130475U</b>	Carta per rivestimento cilindri (sottostrato per codice 2130475T) - 300 mt <i>Paper for rollers wrapping (underlying strata for code 2130475T) - 300 mt</i> <i>Papier pour habillage cylindres (sous-couche pour code 2130475T) - 300 mt</i>
<b>2130475Z</b>	Guarnizione per motore autoclave (tutti i tipi di autoclave) <i>Gasket for autoclave motor (all models of autoclave)</i> <i>Joint pour moteur autoclave (tous modèles d'autoclave)</i>

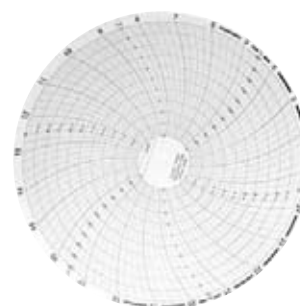

2130475L



2130475S



2130475T



2130475U



2130475Z

**ACCESSORI E RICAMBI VARI**  
**ACCESSORIES AND SPARE PARTS**  
**ACCESSOIRES ET PIÈCES DE RECHANGE**

**Spazzole parapolverino**  
**Brushes for rubber dust**  
**Brosses pour poudrette**

<b>Codice</b> <i>Code</i> <i>Code</i>	<b>Descrizione</b> <i>Description</i> <i>Description</i>
<b>2130476</b>	Spazzola parapolverino al metro senza alette <i>Brush for rubber dust in meters without wings</i> <i>Brosse pour poudrette en mètres sans ailettes</i>
<b>2130477</b>	Spazzola parapolverino al metro con alette <i>Brush for rubber dust in meters c/w wings</i> <i>Brosse pour poudrette en mètres avec ailettes</i>



2130477

2130476

**Graffatrice pneumatica**  
**Pneumatic stapler**  
**Agrafeuse pneumatique**

<b>Codice</b> <i>Code</i> <i>Code</i>	<b>Descrizione</b> <i>Description</i> <i>Description</i>	<b>Confezione</b> <i>Box</i> <i>Conditionnement</i>
<b>2130478</b>	Graffatrice pneumatica per prestampato 8/14 <i>Pneumatic stapler for precured tread 8/14</i> <i>Agrafeuse pneumatique pour la bande de roulement 8/14</i>	–
<b>2130479</b>	Punti metallici per graffatrice 8/6 - 6x12 da 1/4" <i>Metal staples for stapler 8/6 - 6x12 - 1/4"</i> <i>Points métalliques pour agrafeuse 8/6 - 6x12 - 1/4"</i>	10.000 pcs.
<b>2130480</b>	Punti metallici per graffatrice 8/8 - 8x12 da 5/16" <i>Metal staples for stapler 8/8 - 8x12 - 5/16"</i> <i>Points métalliques pour agrafeuse 8/8 - 8x12 - 5/16"</i>	10.000 pcs.



**Solvente per pulizia stampi e tallonette**  
**Cement to clean moulds and bead rims**  
**Diluant pour nettoyage moules et talonnettes**

<b>Codice</b> <i>Code</i> <i>Code</i>	<b>Descrizione</b> <i>Description</i> <i>Description</i>
<b>2140468</b>	Solvente per la pulizia di stampi e tallonette - 25 kg <i>Cement to clean moulds and bead rims - 25 kg</i> <i>Diluant pour nettoyage de moules et talonnettes - 25 kg</i>
<b>2140469</b>	Contenitore in acciaio inox per decantazione stampi cm 100x100 H 40 completo di rubinetto, coperchio e piedi supporto <i>Inox steel container for moulds' decantation cm 100x100 H 40 c/w tap, cover and support feet</i> <i>Récipient en acier inox pour décantage diluant sur les moules cm 100x100 H 40 complet de robinet, couvercle et pieds de support</i>



2140468

# ACCESSORI ANTINFORTUNISTICA

## ACCESSORIES FOR INDUSTRIAL ACCIDENTS PREVENTION

## ACCESSOIRES POUR LA PRÉVENTION DES ACCIDENTS SUR LE TRAVAIL



2140477

Codice / Code / Code	Descrizione / Description / Description
2140477	Guanti bianchi da lavoro in pelle fiore bovina White work gloves in cow soft leather Gants blancs de travail en peau bovine souple



2140481

Freq.	H	M	L	SNR
Attenuaz. in DB Attenuation in DB Atténuation en DB	31	21	12	24

Codice / Code / Code	Descrizione / Description / Description
2140481	Cuffia antirumore g 130 Noise protecting cap g 130 Coiffe antibruit g 130



2140477S

Ideali per  
ricostruzione  
pneumatici  
  
Ideal for tyre re-  
treading  
  
Idéaux pour  
rechapage pneus

Codice / Code / Code	Descrizione / Description / Description
2140477S	Guanti grigi da lavoro in crosta 7cm Grey work gloves in leather 7 cm Gants gris de travail en peau 7 cm



2140482

Freq.	H	M	L	SNR
Attenuaz. in DB Attenuation in DB Atténuation en DB	30	24	22	28

Codice / Code / Code	Descrizione / Description / Description
2140482	Tappi antirumore (1 paio) Noise protecting plugs (1 pair) Bouchons antibruit (1 paire)



2140478

Codice / Code / Code	Descrizione / Description / Description
2140478	Guanti per alte temperature a manichetta High temperatures gloves with sleeve Gants pour hautes températures avec manche



2140483



2140484

Codice / Code / Code	Descrizione / Description / Description
2140483	Occhiali neutri a stanghetta Neutral spectacles with arm Lunettes neutres avec branches
2140484	Lenti temperate di ricambio per occhiali Tempered spare lens for spectacles Verres trempés de rechange pour lunettes

Per polveri a  
bassa nocività

For low har-  
mfulness dusts

Pour poudres à  
basse nocivité



2140479



2140480

Per polveri ad  
alta nocività

For high har-  
mfulness dusts

Pour poudres à  
haute nocivité

Codice / Code / Code	Descrizione / Description / Description
2140479	Maschera antipolvere 3M Dust protecting mask 3M Masque antipoudre 3M
2140480	Maschera con filtro in carbone 3M Mask with coal filter 3M Masque avec filtre en charbon 3M



2140485 / 2140485A

Codice / Code / Code	Descrizione / Description / Description
2140485	Schermo in policarbonato antiurto Shockproof polycarbonate shield Écran antichoc en polycarbonate
2140485A	Caschetto ABS blu con regolazione a cricchetto ABS blue helmet with jack adjustment Casque en ABS bleu avec réglage à cric

**Butyl tipo "S"**  
**Butyl type "S"**  
**Butyl type "S"**

Codice Code Code	Ø Ø Ø	Dimensione dei pneumatici suggeriti Size of suggested tyres Dimension des pneus conseillés	
2150500	5	350 - 5	
2150503	10	450 - 10	
2150504	10	145 - 10	
2150505	12	125 - 12	
2150506	12	135 - 12	
2150507	12	145/155 - 12	520/560/600 - 12
2150509	13	135 - 13	
2150510	13	145 - 13	
2150511	13	155 - 13	615 - 13
2150512	13	165 - 13	560 - 13
2150513	13	175 - 13	640 - 13
2150513S	13	185/60 - 13	
2150514	14	145 - 14	
2150515	14	155 - 14	560 - 14
2150516	14	165 - 14	650 - 14
2150517	14	175/185 - 14	
2150518	14	185/195/60 - 14	
2150519	14	195/205 - 14	750 - 14
2150520	14	215/225/70 - 14	
2150521	15	135/145 - 15	
2150523	15	155 - 15	560/600 - 15
2150525	15	175/185 - 15	
2150526	15	185/195/60 - 15	
2150527	15	205/215 - 15	
2150527S	15	650/670 - 15	
2150528A	16	175 - 16	600/640 - 16
2150528B	16	195 - 16	650 - 16
2150530	16	205 - 16	700 - 16
2150531	16	750 - 16	
2150532	16	825 - 16	
2150532A	17	425 - 17	130/80 - 17
2150533	17.5	8/8.5 - 17.5	
2150533A	18	425 - 18	130/80 - 18
2150533D	18	225/45 - 17.18	
2150534	20	750 - 20	
2150535	20	825 - 20	
2150536	20	900 - 20	
2150537	20	1000 - 20	
2150538	20	1100 - 20	
2150539	20	12/1300 - 20	
2150540	22.5	11/12 - 22.5	
2150541	22.5	315/80 - 22.5	
2150541A	22.5	385/65 - 22.5	

**NOTE / NOTES / NOTES:**

- Per le camere tipo "S" l'uso del flap dipende dalle condizioni d'uso.
- For "S" model curing tubes the flap use depends on use conditions.
- Pour les chambres de cuisson modèle "S" l'utilisation du flap dépend des conditions d'utilisation.

**Butyl tipo "R"**  
**Butyl type "R"**  
**Butyl type "R"**

Codice Code Code	Ø Ø Ø	Dimensione dei pneumatici suggeriti Size of suggested tyres Dimension des pneus conseillés	
2150542	14	195/205 - 14	
2150543	15	175/185 - 15	
2150544	15	205/215 - 15	
2150545A	16	195 - 16	650 - 16
2150545B	16	205 - 16	700 - 16
2150546	16	750 - 16	
2150547	16	825 - 16	
2150548	19.5	265/70 - 19.5	
2150548A	19.5	305/70 - 19.5	
2150549	20	750 - 20	
2150550	20	825 - 20	
2150551	20	900 - 20	
2150552	20	1000 - 20	
2150553	20	1100 - 20	
2150554	20	12/1300 - 20	
2150555	22.5	11/12 - 22.5	
2150556	22.5	315/80 - 22.5	
2150557	24	13/1400 - 24	
2150558	24.5	11 - 24.5	1200 - 24

**NOTE / NOTES / NOTES:**

- La camera tipo "R" richiede sempre l'uso del flap
- "R" model curing tubes should always be used with flap
- Les chambres de cuisson modèle "R" doivent toujours être utilisées avec le flap



**Butyl flaps per ricostruzione pneumatici - Anello**  
**Butyl flaps for tyres' retreading - Ring**  
**Flaps butyl pour rechapage pneus - Anneau**

Codice Code Code	Ø Ø Ø	Misura Size Dimension	Peso Weight kg Poids	Dimensione pneumatici Tyre sizes Dimensions pneus
2150570	16	B - 16	1.2	600 / 640 / 650 / 700 / 750 - 16
2150571	20	B - 20	2.7	750 / 825 / 900 - 20
2150572	20	E - 20	3.4	10 / 11 / 1200 - 20
2150573	22.5	P - 22.5	3.7	315 / 80 - 22.5 - 11 / 12 / 13 - 22.5



**Butyl flaps per ricostruzione pneumatici - Striscia**  
**Butyl flaps for tyres' retreading - Strip**  
**Flaps butyl pour rechapage pneus - Bande**

Codice Code Code	Ø Ø Ø	Misura Size Dimension	Peso Weight kg Poids	Dimensione pneumatici Tyre sizes Dimensions pneus
2150573S	24	F - 24	5.2	1300 - 24 / 1400 - 24
2150574	25	F - 25	7.5	15 / 17.5 - 25
2150574A	25	F - 25 L	8.3	20.5 - 25 / 23.5 - 25
2150575	28	F - 28	6.8	13 - 28
2150576	30	F - 30	8.3	Cerchio / Rim / Jante 30"
2150577	34	F - 34	9.5	Cerchio / Rim / Jante 34"



**Butyl tipo "U-Tube"**  
**Butyl type "U-Tube"**  
**Butyl type "U-Tube"**

Codice Code Code	Ø Ø Ø	Dimensione pneumatici Tyre sizes Dimensions pneus
2150600	15	750 - 15
2150602	16	700 - 16
2150604	16	750 - 16
2150606	17	750 - 17
2150608	20	900 - 20
2150610	20	1000 - 20
2150612	20	1100 - 20
2150614	20	1200 - 20
2150616	22.5	275 / 295 - 22.5
2150618	22 - 22.5	11 - 22 / 22.5
2150620	24.5	11 - 24.5



Tipo "U-TUBE" con piastrina di protezione, valvola estraibile, piede piatto.  
 Le camere di cottura U-TUBE sono leggere e facili da maneggiare, così da essere utilizzate nel processo di ricostruzione prevulcanizzato (sistema a freddo). Sono realizzate con una speciale miscela per ottenere le migliori prestazioni in termini di numero di camere.

Type "U-TUBE" with rubber base, stem valve, flat basis.  
 The curing tubes "U-TUBE" are light and easy to handle, to be used in cold retreading system. They are made of a special compound to gain the best performances in terms of number of curing tubes.

Type "U-TUBE" avec plaquette de protection, valve extractible, base plate.  
 Les chambres de cuisson U-TUBE sont légères et faciles à manier, pour être utilisées en le procès de rechapage pré-vulcanisé (système à froid). Elles sont faites en un mélange spécial pour obtenir les performances les meilleures en termes de nombre de chambres.



**FUSTINI DI COTTURA**  
**CURING BLADDERS**  
**MEMBRANES DE CUISSON**

Codice Code Code	Misura Size Dimension	H	A	B	C	D	kg	Pneumatico suggerito Suggested tyre Pneu conseill�
2160581	C0 (4776)	311	302	203	21	12,7	3,1	125-12 • 135-12
2160582	C1 (6299)	330	325	217	22	13	3,7	135-13 • 145-13
2160583	C2 (6228)	330	370	217	22	13	4,5	155-13 • 165-13
2160584	C3 (6297)	464	412	248	21	13	5,8	T.L./Light Van
2160584A	C4 (6390)	410	400	248	21	13	5,2	T.L./Light Van
2160584B	C5 (6319)	460	435	270	21	13	7,4	T.L./Light Van
2160584C	C6 (6320)	550	435	270	21	13	8,5	T.L./Light Van
2160584F	C83 (8376)	525	600	375	26	12,5	13,4	Truck 20"/22"/22.5" medium
2160584G	C28 (2895)	615	600	375	26	12,5	15,3	Truck 20"/22.5" large
2160584H	C20/6 (H20/6)	455	663	445	32	16	18,4	Truck 24"
2160584L	C76 (7646)	545	822	375	26	13	18,8	Truck 22.5" large
2160584P	MO (RP-12/1)	227	420	207	23	11	2,8	10"/12"
2160585	M1 (RP-13/3)	300	410	225	23	11	3,7	135-13 • 145-13
2160586	M2 (RP-13/4)	320	410	225	23	11	3,9	155-13 • 165-13
2160587	M3 (RP-13/5)	345	450	225	23	12,5	4,5	175-14 • 185-14
2160588	M4 (RP-13/7)	395	450	225	23	12,5	4,9	195-14 • 205-15
2160589	M5 (RP-13/9)	490	467	225	23	11	6,4	T.L./Light Van
2160590	M20/35 (RP-20/3)	480	665	345	28	15,5	11,4	Truck 20"/22.5" medium
2160591	M20/5 (RP-20/5)	550	665	345	28	15,5	12,6	Truck 20"/22.5" large

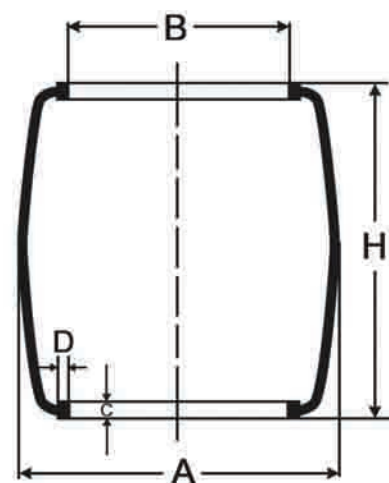

**Envelopes esterni**  
**Outer envelopes**  
**Envelopes extérieurs**

<b>Codice</b> <i>Code</i> <i>Code</i>	<b>Modello</b> <i>Model</i> <i>Modèle</i>	<b>Diam. est</b> x <b>tall. / tall.</b> <i>Out. diam. x bead / bead</i> <i>Diam. ext. x talon / talon</i>	<b>Dimensione dei pneumatici suggeriti</b> <i>Size of suggested tyres</i> <i>Dimension des pneus conseillés</i>
<b>2170598</b>	SL - 13	mm 1130 x 800 inch 44.4 x 31.5	1200 - 20 • 385/65 - 22.5 • 15 - 22.5 • 445/65 - 19.5 13 - 22.5 • 425/65 - 22.5 • 1200 - 24
<b>2170599</b>	SL - 12	mm 1160 x 780 inch 45.6 x 30	1200 - 20 • 1300 - 20 • 365/80 - 20 • 13 - 22.5 • 15 - 22.5 385/65 - 22.5 • 1200 - 24
<b>2170600</b>	SL - 11/12	mm 1067 x 710 inch 42 x 28	1100 - 20 • 1200 - 20 • 1100 - 22 • 12 - 22.5 • 315/80 - 22.5 11 - 24.5 • 285/75 - 24.5
<b>2170601</b>	SL - 11	mm 1020 x 700 inch 40 x 27.5	1100 - 20 • 11 - 22.5 • 12 - 22.5 • 315/75 - 22.5
<b>2170602</b>	SL - 10	mm 1000 x 680 inch 39.3 x 26.7	1000 - 20 • 11 - 22.5 • 275/70 - 22.5 • 275/80 - 22.5 295/80 - 22.5 • 305/70 - 22.5 • 315/70 - 22.5 • 425/55 - 19.5
<b>2170602A</b>	SL - 9	mm 960 x 610 inch 37.8 x 24	900 - 20 • 10 - 22.5 • 305/70 - 19.5 • 305/60 - 22.5
<b>2170603</b>	SL - 8	mm 945 x 570 inch 37.4 x 22.4	700 - 20 • 750 - 20 • 825 - 20 8 - 22.5 • 9 - 22.5 • 255/70 - 22.5 • 305/70 - 19.5
<b>2170604</b>	SL - 78	mm 890 x 590 inch 35 x 23.2	285/70 - 19.5 • 650 - 20 900 - 15 • 10 - 15 • 10 - 17.5
<b>2170604A</b>	SL - 76	mm 840 x 540 inch 33 x 22	825 - 15 • 825-16 • 245/70 - 19.5 • 265/70 - 19.5
<b>2170605</b>	SL - 7	mm 795 x 500 inch 31.3 x 20	10 - 16.5 • 12 - 16.5 • 215/75 - 16 • 225/75 - 16 • 215 - 16 750 - 16 • 205 - 16 • 10 - 15 • 7.50 - 15 • 825 - 15 300 - 15 • 8.5/17.5 • 9.5/17.5 • 235/70 - 19.5 • 245/70 - 19.5
<b>2170606</b>	SL - 6	mm 714 x 440 inch 28 x 17.3	8 - 17.5 • 700 - 16 • 205/75 - 16 235/75 - 15 • 215 - 15 • 215 - 14 28x9 - 15 • 700 - 15 • 2.50 - 15 • 215/75 - 17.5
<b>2170607</b>	SL - 4	mm 650 x 430 inch 25.6 x 17	195 - 14 • 205 - 14 • 185 - 15 • 600 - 16 • 650 - 16 175/75 - 16 • 185 - 16 • 195 - 16 • 7.00 - 12 • 27x10-12 7 - 17.5
<b>2170608</b>	SL - 2	mm 610 x 380 inch 24 x 15	165 - 14 • 165/70 - 14 • 175 - 14 • 175/70 - 14 • 185 - 14 185/75 - 14 • 750-10 • 23x10-12 • 7.00 - 12
<b>2170609A</b>	SL - 1	mm 530 x 390 inch 20.8 x 14.9	23x9-10 • 6.50 - 10
<b>2170609B</b>	SL - 0	mm 506 x 335 inch 19.9 x 13.1	21x8-9 • 6.00 - 9
<b>2170609C</b>	SMALL	mm 492 x 360 inch 19.5 x 14.1	18x7-8 • 500 - 8
<b>2170609D</b>	18x13	mm 457 x 330 inch 18 x 13	16x6-8 • 15x4 - 1/2-8 • 500 - 8 • 400 - 8



**Envelopes esterni tipo "XL" - Outer envelopes type "XL"**  
**Envelopes extérieurs type "XL"**

Envelopes esterni tipo "XL" quando è richiesta una gonna più lunga.

Quando è usato un cerchio tipo "Oliver" o equivalente

*Outer envelopes "XL" type when extra skirt is needed. When a rim type "Oliver" or equivalent flanges are used*

*Envelopes ext. type "XL" quand on a besoin d'une bordure plus longue. Quand on utilise une jante type "Oliver" ou correspondante*

<b>Codice</b> <i>Code</i> <i>Code</i>	<b>Modello</b> <i>Model</i> <i>Modèle</i>	<b>Diam. est x tall. / tall.</b> <i>Out. diam. x bead / bead</i> <i>Diam. ext. x talon / talon</i>	<b>Dimensione dei pneumatici suggeriti</b> <i>Size of suggested tyres</i> <i>Dimension des pneus conseillés</i>
<b>2170610</b>	XL - 13	mm 1130 x 880 inch 44,4 x 34.6	1200 - 20 • 385/65 - 22.5 • 15 - 22.5 • 445/65 - 19.5 13 - 22.5 • 425/65 - 22.5 • 1200 - 24
<b>2170610A</b>	XL - 11/12	mm 1067 x 790 inch 42 x 31	315/80 - 22.5 • 12 - 22.5 1100 - 20 • 1200 - 20
<b>2170610C</b>	XL - 11	mm 1020 x 770 inch 40 x 30	305/70 - 22.5 • 315/70 - 22.5 295/80 - 22.5 • 11 - 22.5 • 1000 - 20
<b>2170610E</b>	XL - 10	mm 1000 x 740 inch 39 x 29	275/80 - 22.5 • 305/70 - 19.5 900 - 20
<b>2170610F</b>	XL - 9	mm 960 x 660 inch 37.8 x 26	
<b>2170610G</b>	XL - 8	mm 945 x 640 inch 37 x 25	700 - 20 • 750 - 20 825 - 20
<b>2170610L</b>	XL - 76	mm 840 x 570 inch 33 x 23	245/70 - 19.5
<b>2170610N</b>	XL - 7	mm 795 x 600 inch 31 x 24	8-17.5 • 8.5 - 17.5 750 - 16 • 205 - 16

**Envelopes esterni - Outer envelopes - Envelopes extérieurs**

Quando è usato un cerchio tipo "Arc" o equivalente - *When a rim type "Arc" or equivalent is used*

*Quand on utilise une jante type "Arc" ou correspondante*

<b>Codice</b> <i>Code</i> <i>Code</i>	<b>Modello</b> <i>Model</i> <i>Modèle</i>	<b>Diam. est x tall. / tall.</b> <i>Out. diam. x bead / bead</i> <i>Diam. ext. x talon / talon</i>	<b>Dimensione dei pneumatici suggeriti</b> <i>Size of suggested tyres</i> <i>Dimension des pneus conseillés</i>
<b>2170611N</b>	48 X 45	mm 1230 x 1220 inch 48.7 x 48	1400 - 24 • 445/65 - 22.5
<b>2170612</b>	44 X 38	mm 1130 x 980 inch 44.4 x 38.5	1200 - 20 • 385/65 - 22.5 • 15 - 22.5 • 445/65 - 19.5 13 - 22.5
<b>2170612A</b>	44 X 36	mm 1130 x 980 inch 44.4 x 36	385/65 - 22.5
<b>2170613</b>	42 X 36	mm 1075 x 920 inch 42.3 x 36.2	315/80 - 22.5 • 315/75 - 22.5 • 335/80 - 20 13/80 - 20 • 12/80 - 20 • 1100 - 20 • 1000 - 20
<b>2170613A</b>	42 X 34	mm 1075 x 864 inch 42.3 x 34	11-24.5 • 295/80-24.5 • 12-22.5
<b>2170614</b>	40 X 34	mm 1020 x 870 inch 40 x 34.2	285/75 - 24.5 • 11 - 22.5 • 10 - 22.5
<b>2170614A</b>	40 X 32	mm 1020 x 813 inch 40 x 32	285/75 - 24.5 • 295/70 - 22.5 • 295/75 - 22.5 275/80 - 22.5 • 295/80 - 22.5 • 11 - 22.5
<b>2170614D</b>	35 X 29	mm 889 x 752 inch 35 x 29.6	255/70 - 22.5 • 275/70 - 22.5 • 305/70 - 19.5 285/70 - 19.5 • 265/70 - 19.5 • 245/70 - 19.5
<b>2170614F</b>	32 X 28	mm 816 x 712 inch 32.1 x 28	225/70 - 19.5 • 235/70 - 19.5 • 245/70 - 19.5 225/90 x 17.5 • 9.5 - 17.5 • 8.25 - 16
<b>2170614H</b>	32 X 26	mm 816 x 660 inch 32.1 x 26	225/75 - 17.5 • 235/75 - 17.5
<b>2170614L</b>	29 X 25	mm 725 x 650 inch 28.5 x 25.6	700-16 • 225/75 - 16 • 205/75 - 16 215/85 - 16 • 215/75 - 15
<b>2170614N</b>	27 X 21	mm 680 x 590 inch 26.8 x 23.2	185/75 - 16 • 195/75 - 16 • 195/75 - 14

**Envelopes interni "Universal"**  
**"Universal" inner envelopes**  
**Envelopes intérieurs "Universal"**

Codice Code Code	Misura Size Dimension	Dimensioni dei pneumatici suggerite Suggested tyre sizes Dimensions pneu conseillées	Dimensioni (mm) Sizes (mm) Dimensions (mm)		
			A	B	C
<b>2170615</b>	1300 x 500	16.5-22.5 • 18-22.5 425/65-22.5 • 445/65-22.5 • 1200 - 24	1300	500	900
<b>2170615B</b>	1340 x 560	11-24 • 12-24 • 13-24 • 12-24,5 • 562-22,5	1340	560	900
<b>2170616</b>	1200 x 560	1100-24 • 11-24.5 • 12-24.5 285/75-24.5 • 295/75-24.5 • 305/75-24.5 • 315/75-24.5 285/80-24.5 • 295/80-24.5 • 305/80-24.5	1200	560	870
<b>2170616D</b>	1160 x 480	385/65 - 22.5 • 12.00-20 • 13.00-20 • 13.80-20 14.80-20 • 365/80-20 • 15.22.5	1160	480	900
<b>2170616M</b>	1180 x 580	11 - 24.5	1180	580	940
<b>2170617</b>	1100 x 480	1100-20 • 1200-20 • 1100-22 • 425/55-19.5 12-22.5 • 13-22.5 • 15-22.5 • 305/70-22.5 • 315/75-22.5 315/80-22.5 • 385/65-22.5	1100	480	860
<b>2170618</b>	1060 x 480	11-22.5 • 275/80-22.5 • 295/80-22.5	1060	480	810
<b>2170619</b>	1010 x 480	8.25-20 • 900-20 • 1000-20 • 10-22.5 • 305/70-19.5 • 305/60 - 22.5 255/70-22.5 • 275/70-22.5 • 285/70-22.5 • 305/70-22.5 • 12-16.5	1010	480	790
<b>2170620</b>	960 x 440	265/70-19.5 • 285/70-19.5	960	440	690
<b>2170621</b>	880 x 380	825-15 • 825-16 • 9.5-17.5 • 10-17.5 • 245/70 - 19.5 • 235/75 - 19.5	880	380	675
<b>2170622</b>	780 x 400	7.50-15 • 750-16 • 215/75-16 • 225/75-16 8-17.5 • 8.5-17.5 • 9-17.5 • 205/75-17.5 215/75-17.5	780	400	640
<b>2170623</b>	700 x 315	195-14 • 205-14 • 215-14 • 250/70-15 • 700-15 • 10-16.5 185/75-16 • 195/75-16 • 600-16 • 6.50-16 • 205/75-16	700	315	570

L'envelope ha un foro per la valvola e questa zona è rinforzata - I prezzi delle envelopes non includono la valvola.  
 The envelope has a hole for the valve and this area is reinforced. Envelopes prices do not include the valve.  
 L'enveloppe a un trou pour la valve et cette zone est renforcée - La valve n'est pas incluse dans les prix des envelopes.

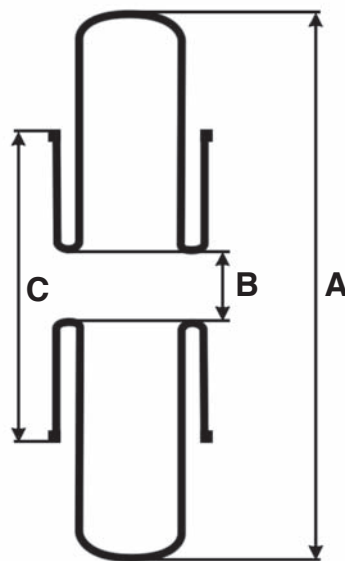

**Envelopes interni per gomma piena**  
**Inner envelopes for solid tyres**  
**Envelopes intérieurs pour pneus pleins**

Codice Code Code	Misura Size Dimension	Dimensioni dei pneumatici suggerite Suggested tyre sizes Dimensions pneu conseillées	Dimensioni Sizes Dimensions		
			A	B	C
2170701	5.00-8	15x4 1/2-8 • 125/75-8 • 4.00-8 • 5.00-8	350	190	105
2170703	18x7-8 (16x6-8)	18x7-8 • 180/70-8 • 16x6-8 • 150/75-8 • 18x7-8	350	190	130
2170711	6.00-9	6.00-9 • 6.50-10	420	210	120
2170712	21x8-9	21x8-9 • 200/75-9	420	210	185
2170721	6.50-10	6.50-10	480	230	150
2170722	200/50-10	200/50-10	400	230	180
2170723	23x9-10	23x9-10 • 225/75-10	490	230	180
2170731	7.00-12	7.00-12	510	280	155
2170732	23x10-12	23x10-12	460	280	230
2170733	27x10-12	27x10-12 • 250/75-12	530	280	230
2170741	8.25-15	2.00-15 • 7.50-15 • 8.25-15	650	380	170
2170742	2.50-15	2.50-15 • 225/75-15 • 250/70-15 • 28x9-15	570	380	186
2170743	3.00-15	3.00-15 • 315/70-15	650	380	220
2170744	10.00-20	10.00-20 • 12.00-20	865	470	270

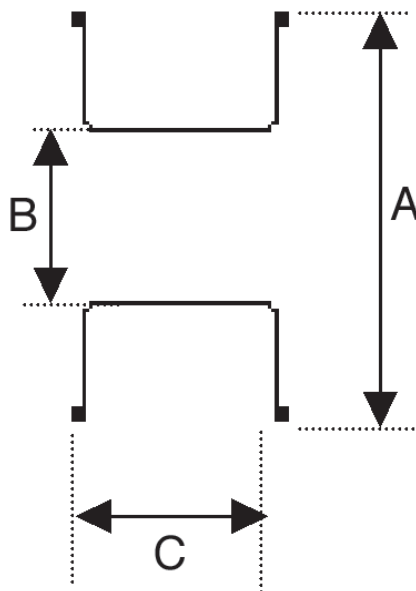

**Cuscini per vuoto Envelope**  
**Envelope vacuum pads**  
**Coussins pour vide Envelope**

- Prodotto in gomma butilica particolarmente resistente al calore (da 100°C a 150°C);
- L'elasticità della miscela non provoca deformazione al battistrada;
- Idoneo a qualsiasi tipo di sistema prestampato;
- Evita l'impronta della valvola envelope sul battistrada;
- Estetica perfetta del pneumatico (nessuna impronta);
- Applicazione semplice e veloce - non necessita fissaggio;
- Lunga durata.

- Produced in butyl rubber particularly heat resistant (from 100°C to 150°C);
- The high elasticity of the compound doesn't generate deformations to the tread;
- Suitable for any kind of precured tread system;
- It avoids the impression of the envelope valve on the tread;
- Perfect design of tyre (no impression);
- Easy and quick application - no fixing required;
- Long life.

- Produit en caoutchouc butylique particulièrement résistant à la chaleur (de 100°C à 150°C);
- La haute élasticité du mélange ne cause pas de déformations à la chape;
- Indiqué pour tous types de système bande pré-vulcanisée;
- Il évite l'empreinte de la valve envelope sur la chape;
- Design parfait du pneu (pas d'empreinte);
- Application facile et rapide - pas besoin de fixation;
- Longue durée.

Codice Code Code	Descrizione Description Description	Dimensioni (mm) Sizes (mm) Dimensions (mm)		Sistema Prestampato Precured tread system Système bande pré-vulcanisée
		A	B	
2170800	Cuscino per vuoto Envelope Super single <i>Super single envelope vacuum pad</i> <i>Coussin pour vide envelope Super single</i>	1385	165	Sistema doppio envelope <i>Double envelope system</i> <i>Système envelope double</i>
2170801	Cuscino per vuoto envelope Super single <i>Super single envelope vacuum pad</i> <i>Coussin pour vide envelope Super single</i>	740	165	Envelope / Cerchio / Camera - Sistema ARC <i>Envelope / Rim / Tube - ARC system</i> <i>Envelope / Jante / Chambre - Système ARC</i>
2170802	Cuscino per vuoto envelope Autocarro <i>Truck envelope vacuum pad</i> <i>Coussin pour vide envelope camion</i>	1250	175	Sistema doppio envelope <i>Double envelope system</i> <i>Système envelope double</i>
2170803	Cuscino per vuoto envelope Autocarro <i>Truck envelope vacuum pad</i> <i>Coussin pour vide envelope camion</i>	670	175	Envelope / Cerchio / Camera - Sistema ARC <i>Envelope / Rim / Tube - ARC system</i> <i>Envelope / Jante / Chambre - Système ARC</i>
2170804	Cuscino per vuoto envelope Trasporto medio leggero <i>Medium light truck envelope vacuum pad</i> <i>Coussin pour vide envelope petite camionnette</i>	835	135	Sistema doppio envelope <i>Double envelope system</i> <i>Système envelope double</i>
2170805	Cuscino per vuoto envelope Trasporto medio leggero <i>Medium light truck envelope vacuum pad</i> <i>Coussin pour vide envelope petite camionnette</i>	450	135	Envelope / Cerchio / Camera - Sistema ARC <i>Envelope / Rim / Tube - ARC system</i> <i>Envelope / Jante / Chambre - Système ARC</i>



**Accessori per cura e riparazione envelope**  
**Accessories for care and repairing of envelopes**  
**Accessoires pour soin et réparation envelopes**

Codice Code Code	Descrizione Description Description	Rif. Ref. Réf.
2190100	Nastro in polipropilene perforato per alte temperature (>137°C). Facilita il procedimento e aumenta la durata degli envelopes - 305mm x 0,015mm (14kg) <i>Polypropylene perforated tape for high temperature (&gt;137°C). It makes the processing easy and improves the envelope life - 305mm x 0,015mm (14kg)</i> <i>Bande en polypropylène perforée pour hautes températures (&gt;137°C). Elle facilite le procédé et augmente la durée des envelopes - 305mm x 0,015mm (14kg)</i>	15-008
2190100A	Nastro in polipropilene perforato per temperature <137°C - 305mm x 0,04mm (23kg) <i>Polypropylene perforated tape for temperatures &lt;137°C - 305mm x 0,04mm (23kg)</i> <i>Bande en polypropylène perforée pour températures &lt;137°C - 305mm x 0,04mm (23kg)</i>	15-010
2190100B	Nastro in polipropilene perforato per temperature <137°C - 460mm x 0,04mm (36kg) <i>Polypropylene perforated tape for temperatures &lt;137°C - 460mm x 0,04mm (36kg)</i> <i>Bande en polypropylène perforée pour températures &lt;137°C - 460mm x 0,04mm (36kg)</i>	15-012
2190101	Kit riparazione envelope. Per riparazioni permanenti di envelope danneggiate. Contiene: 2 rotoli da 1kg gomma riparazione envelope / 1 kg soluzione adesiva / 1 kg liquido buffer / 1 raschietto <i>Envelope repair kit. For permanent repairs to damaged curing envelopes. Contains: 2 rolls of 1 kg of envelope repair gum/ 1kg envelope repair cement / 1kg cleaner fluid / 1 scraper</i> <i>Jeu pour réparation envelope. Pour réparations permanentes d'envelopes endommagés. Il contient: 2 rouleaux à 1 kg de caoutchouc pour réparation envelope / 1 kg solution adhésive / 1 kg liquide buffer / 1 racloir</i>	14-340



2190100



2190101

**Soluzione a base acqua**  
**Water base Retread Cement**  
**Solution à base d'eau**

Si utilizza come la soluzione tradizionale, ma non contiene sostanze pericolose e non è infiammabile. Il colore varia da grigio chiaro a nero quando la soluzione asciuga, indicando in tal modo quando è possibile continuare il processo di ricostruzione. Compatibile con tutti i sistemi di ricostruzione. Sufficiente per circa 300 pneumatici, molto più di una soluzione a base solvente.

*Performs like conventional retreading cements, contains no hazardous materials, and is non-flammable. Colour changes from light gray to flat black as cement dries, indicating when it is ready to continue the retread process. Compatible with all mold cure and precure retreading systems. Yields over 300 tires per pail, much more than solvent based cements.*

*On la utilise comme la solution traditionnelle, mais elle ne contient pas de substances dangereuses et elle n'est pas inflammable. La couleur change de gris clair à noir quand la solution sèche, en indiquant de cette façon quand il est possible de continuer avec le procédé de rechapage. Compatible avec tous systèmes de rechapage. Suffisante pour env. 300 pneus, beaucoup plus que solutions avec solvant.*

Codice Code Code	Descrizione Description Description	Kg Kg Kg	Rif. Ref. Réf.
2190200	Soluzione WB EF-10 Spray - 18,9 lt (5 galloni) <i>Cement WB EF-10 Spray - 18,9lt (5 gallons)</i> <i>Solution WB EF-10 Vaporisateur - 18,9 lt (5 gallons)</i>	20	16-360
2190201	Soluzione per pulizia WB - 18,9 lt (5 galloni) per pulire il nebulizzatore dopo l'uso <i>WB cleaning solution - 18,9 lt (5 gallons) to clean the sprayer after use</i> <i>Solution pour nettoyage WB - 18,9 lt (5 gallons) pour nettoyer l'atomiseur après l'usage</i>	20	16-370
2190205	Apparecchio airless inox per soluzioni a base acqua (2190200) <i>Inox airless sprayer for water base retread cement (2190200)</i> <i>Vaporisateur airless inox pour solution à base d'eau (2190200)</i>	--	56-287



2190200



2190201



2190205

**Soluzione legante / Fiber bond cement / Solution liante**

Soluzione a presa rapida per applicazione gomma battistrada a caldo e freddo. Disponibile in versione spray o a pennello per ricostruzione e riparazione. Adesione eccellente in tutte le condizioni di umidità.

*A high solid content cement for hot and cold tread rubber application. Available in spray or brush type for retreading and repairing. Excellent adhesion and tack in all humidity conditions.*

*Solution à prise rapide pour application chape à chaud et à froid. Disponible en version vaporisateur ou avec pinceau pour rechapage et réparation. Adhé- sion excellente en toutes conditions de humidité.*

Codice Code Code	Descrizione Description Description	Kg Kg Kg	Rif. Ref. Réf.
2190210	Soluzione spray – 18,9 lt (5 galloni) Spray cement – 18,9lt (5 gallons) Solution vaporisateur – 18,9lt (5 gallons)	16	16-354
2190211	Soluzione spray – 205lt (54 galloni) Spray cement – 205lt (54 gallons) Solution vaporisateur – 205lt (54 gallons)	173	16-355
2190212	Soluzione a pennello – 3,8lt (1 gallone) Brush cement – 3,8lt (1 gallon) Solution avec pinceau – 3,8lt (1 gallon)	4	16-349
2190213	Soluzione a pennello - 18,9lt (5 galloni) Brush cement – 18,9lt (5 gallons) Solution avec pinceau – 18,9lt (5 gallons)	16	16-350
2190214	Soluzione a pennello – 205lt (54 galloni) Brush cement – 205lt (54 gallons) Solution avec pinceau – 205lt (54 gallons)	188	16-351



2190213

**Soluzione V-IO per estrusore / V-IO extruder cement / Solution extrudeuse V-IO**

Soluzione per ricostruzione formulata per avere la massima adesione per applicazioni di fasce estruse a caldo. L'umidità e/o la temperatura non influenzano le proprietà dell'adesione.

*Retread cement formulated for maximum green tack on hot extruder strip applications. Humidity and/or temperature does not affect green tack properties.*

*Solution pour rechapage formulée pour avoir une adhésion max. pour applications des bandes extrudées à chaud. Humidité et température n'in- fluencent pas les propriétés de l'adhésion.*

Codice Code Code	Descrizione Description Description	Kg Kg Kg	Rif. Ref. Réf.
2190220	Soluzione per estrusore – 18,9lt (5 galloni) Extruder cement – 18,9 lt (5 gallons) Solution pour extrudeuse – 18,9 lt (5 gallons)	16	16-346
2190221	Soluzione per estrusore – 205lt (54 galloni) Extruder cement – 205 lt (54 gallons) Solution pour extrudeuse – 205 lt (54 gallons)	173	16-348



2190220

**Sigillante butile profili interni / Butyl innerliner sealer / Solution butyle Innerliner**

Questa miscela di due parti, quando viene appli- cata con il pennello sui profili interni danneggiati, si vulcanizza a temperatura ambiente e rigenera le proprietà di ritenzione aria del profilo interno. Soluzione pesante, viscosa al butile da mescolare con l'attivatore. Il sigillante è utilizzabile per 3 ore dopo che gli ingredienti sono stati mescolati.

*This two part mixture, when brushed onto dama- ged innerliners, will cure at room temperature and renew the air retention properties of the innerliner. Heavy, viscous butyl cement to be mixed with ac- tivator. Once ingredients are mixed, sealer is usa- ble for up to 3 hours.*

*Ce mélange de deux parties, quand il est appliqué par le pinceau sur le profil intérieur endommagé, vulcanise à température ambiante et réactive les propriétés de rétention de l'air du profil intérieur. Solution butyle visqueuse, lourde à être mélangée avec l'activateur. La solution peut être utilisée pour 3 heures après le mélange des ingrédients.*

Codice Code Code	Descrizione Description Description	Kg Kg Kg	Rif. Ref. Réf.
2190230	Sigillante - 3,8 lt (1 gallone) Sealer - 3,8 lt (1 gallon) Solution - 3,8 lt (1 gallon)	4	16-290
2190231	Attivatore - 3,8 lt (1 gallone) (per 2190230) Activator - 3,8 lt (1 gallon) (for 2190230) Activateur - 3,8 lt (1 gallon) (pour 2190230)	4	16-239
2190232	Sigillante - 18,9 lt (5 galloni) Sealer - 18,9 lt (5 gallons) Solution - 18,9 lt (5 gallons)	18	16-291
2190233	Attivatore - 18,9 lt (5 galloni) (per 2190232) Activator - 18,9 lt (5 gallons) (for 2190232) Activateur - 18,9 lt (5 gallons) (pour 2190232)	18	16-240



2190230



2190232



**Solvente per gomma**  
**Rubber solvent**  
**Solvant pour caoutchouc**

Soluzione per diluire i prodotti a base di solvente quando si seccano a causa di un'eventuale evaporazione degli ingredienti originali.

*A high grade solvent used for thinning solvent based products that may have become thick due to evaporation of the original solvent based mixture.*

*Solution pour diluer les produits à base de solvant quand ils sèchent à cause de l'évaporation éventuelle des ingrédients originaux.*

<b>Codice</b> Code Code	<b>Descrizione</b> Description Description	<b>Kg</b> Kg Kg	<b>Rif.</b> Ref. Réf.
2190240	Solvente - 3,8 lt (1 gallone) Solvent - 3,8lt (1 gallon) Solvant - 3,8lt (1 gallon)	3	16-220
2190241	Solvente - 18,9 lt (5 galloni) Solvent - 18,9lt (5 gallons) Solvant - 18,9lt (5 gallons)	16	16-221
2190242	Solvente - 205 lt (54 galloni) Solvent - 205lt (54 gallons) Solvant - 205lt (54 gallons)	173	16-222



2190241

**Vernice nera rigenerante a base d'acqua per pneumatici**  
**Water based "new look" black tyre paint**  
**Peinture noire réactivante à base d'eau pour pneus**

Dona alle gomme ricostruite e riparate un aspetto come nuovo. Può essere usato con spray o pennello. Asciuga in 20 minuti a temperatura ambiente. Ricopre tutti i segni dei gessi.

*Give retreads and repaired tires a semi-dull new tire look. Can be sprayed or brushed. Dries in 20 minutes at room temperature. Covers all chalk marks.*

*Elle donne aux pneus rechapés un aspect comme neuf. Elle peut être utilisée avec vaporisateur ou pinceau. Elle sèche dans 20 minutes à température ambiante. Elle couvre toutes traces des craies.*

<b>Codice</b> Code Code	<b>Descrizione</b> Description Description	<b>Kg</b> Kg Kg	<b>Rif.</b> Ref. Réf.
2190251	Vernice nera "new look" - 18,9lt (5 galloni) "New look" black tyre paint - 18,9lt (5 gallons) Peinture noire réactivante - 18,9lt (5 gallons)	22	16-365
2190252	Vernice nera "new look" - 215lt (55 galloni) "New look" black tyre paint - 215lt (55 gallons) Peinture noire réactivante - 215lt (55 gallons)	241	16-363
2190260	Apparecchio economico per applicazione vernice nera a spray Economy tyre paint sprayer Vaporisateur économique pour peinture noire	9	56090
2190261	Pistola di ricambio per apparecchio spray 2190260 Spare gun for sprayer 2190260 Pistolet de rechange pour vaporisateur 2190260	2	56091



2190251



2190260

# **ACCESSORI PER NEGOZI GOMMISTI**

*ACCESSORIES FOR TYRE SHOPS  
ACCESSOIRES POUR VENDEURS ET  
RÉPARATEURS DE PNEUS*



# CRICCHI A BOTTIGLIA

## BOTTLE JACKS

### CRICS À BOUTEILLE

#### Cricchi a bottiglia certificati CE

#### Bottle jacks EC certified

#### Crics à bouteille certifiés CE

Codice Code Code	Descrizione Description Description	Portata tonnellate Capacity tons Capacité tonnes
3010001	Cricco a bottiglia Bottle jack <b>MG 2</b> Cric à bouteille	2
3010002	Cricco a bottiglia Bottle jack <b>MG 3</b> Cric à bouteille	3
3010002A	Cricco a bottiglia Bottle jack <b>MG 3A</b> Cric à bouteille	3
3010003	Cricco a bottiglia Bottle jack <b>MG 5</b> Cric à bouteille	5
3010004	Cricco a bottiglia Bottle jack <b>MG8</b> Cric à bouteille	8
3010005	Cricco a bottiglia Bottle jack <b>MG10</b> Cric à bouteille	10
3010006	Cricco a bottiglia Bottle jack <b>MG 12</b> Cric à bouteille	12

Codice Code Code	Descrizione Description Description	Portata tonnellate Capacity tons Capacité tonnes
3010007	Cricco a bottiglia Bottle jack <b>MG 15</b> Cric à bouteille	15
3010008	Cricco a bottiglia Bottle jack <b>MG 20</b> Cric à bouteille	20
3010008A	Cricco a bottiglia Bottle jack <b>MG 25</b> Cric à bouteille	25
3010009	Cricco a bottiglia Bottle jack <b>MG 30</b> Cric à bouteille	30
3010009A	Cricco a bottiglia Bottle jack <b>MG 40</b> Cric à bouteille	40
3010010	Cricco a bottiglia Bottle jack <b>MG 50</b> Cric à bouteille	50
3010011	Cricco a bottiglia Bottle jack <b>MGD 50</b> Cric à bouteille	50
3010012	Cricco a bottiglia Bottle jack <b>MGD 100</b> Cric à bouteille	100

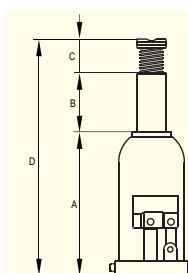

Capacity (t)	2	3	3	5	8	10	12	15	20	25	30	40	50	50	100
A	160	168	210	212	219	219	226	228	234	240	242	246	252	270	300
B	100	105	150	150	150	150	150	150	150	150	150	150	150	150	150
C	50	65	65	75	75	75	75	75	75	75	75	75	75	75	75
D	310	338	425	437	444	444	451	453	459	465	467	396	402	420	450
Weight (Kg)	3,6	3,9	4,2	5	5,9	6,5	8	9	12,1	15	15,5	23,5	28,5	40	87
Reference	MG-2	MG-3	MG-3A	MG-5	MG-8	MG-10	MG-12	MG-15	MG-20	MG-25	MG-30	MG-40	MG-50	MGD-50	MGD-100

**Cricchi a bottiglia oleopneumatici certificati CE**  
**Air hydraulic bottle jacks EC certified**  
**Crics à bouteille oléopneumatiques certifiés CE**

Codice Code Code	Descrizione Description Description	Portata tonnellate Capacity tons Capacité tonnes
3010013	Cricco a bottiglia Bottle jack Cric à bouteille <b>MGH 12</b>	12
3010015	Cricco a bottiglia Bottle jack Cric à bouteille <b>MGH 20</b>	20
3010016	Cricco a bottiglia Bottle jack Cric à bouteille <b>MGH 30</b>	30
3010017	Cricco a bottiglia Bottle jack Cric à bouteille <b>MGH 30A</b>	30



**Cricchi a bottiglia speciali certificati CE**  
**Special bottle jacks EC certified**  
**Crics à bouteille spéciaux certifiés CE**

Codice Code Code	Descrizione Description Description	Portata tonnellate Capacity tons Capacité tonnes
3010018	Cricco a bott. ribassato Lowered bottle jack Cric à bouteille baissé <b>MGS 10</b>	10
3010019	Cricco a bott. speciale (MG10 + struttura) Special bottle jack (MG10 + frame) Cric à bouteille spécial (MG10 + structure) <b>MGL 10</b>	10

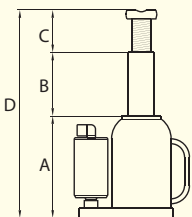

Capacity (t)	12	15	20	30	30	10
A	226	228	234	240	242	131
B	140	140	138	138	138	62
C	75	75	75	75	75	30
D	441	443	447	455	468	223
Weight (Kg)	14	15	15,5	23,5	25,5	5,5
Air pressure required	7 bar / 100 psi					-
Necessary air flow	270 l/min / 9,5 cfm					-
Reference	<b>MGH-12 MGH-15 MGH-20 MGH-30 MGH-30A</b>					<b>MGS-10</b>

# CRICCHI A CARRELLO

## TROLLEY JACKS

## CRICS À CHARIOT

### Cricchi a carrello certificati CE

### Trolley jacks EC certified

### Crucs à chariot certifiés CE

Codice Code Code	Descrizione Description Description	Portata tonnellate Capacity tons Capacité tonnes
3010022	Cricco a carrello Trolley jack Cric à chariot	T1'5H 1,5
3010023	Cricco a carrello Trolley jack Cric à chariot	T2 2
3010023B	Cricco a carrello ribassato Lowered trolley jack Cric à chariot baissé	T2X 2
3010024	Cricco a carrello Trolley jack Cric à chariot	T3 3
3010025	Cricco a carrello Trolley jack Cric à chariot	T6 6
3010026	Cricco a carrello Trolley jack Cric à chariot	T10 10
3010027	Cricco a carrello Trolley jack Cric à chariot	T12 12
3010028	Cricco a carrello Trolley jack Cric à chariot	T15 15
3010029	Cricco a carrello Trolley jack Cric à chariot	T20 20



3010022



3010023



3010024

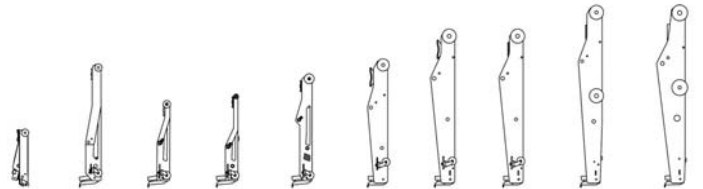

Capacity (t)	2	1,5	2	2	3	6	10	12	15	20
A	120	110	75	48	140	170	170	190	195	200
B	370	665	390	455	385	410	435	390	405	415
C	165	165	135	135	185	220	270	270	265	310
D	490	775	465	520	525	580	605	580	600	615
E	590	1250	880	920	1150	1310	1600	1550	1750	1777
F	1255	2180	1810	1850	2080	2215	2530	2480	2680	2707
G	345	360	360	360	360	414	414	414	375	415
H	275	360	260	260	260	336	386	386	255	302
Weight (Kg)	30	60,5	32	44,5	46	81	123	120,5	145	234,5
Reference	TJE-2	T1,5H	T2	T2X	T3	T6	T10	T12	T15	T20

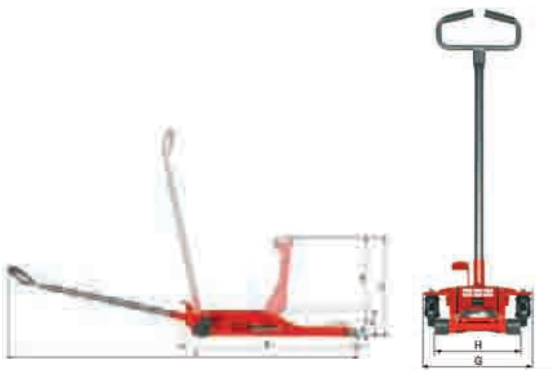

**Cricchi a carrello oleopneumatici certificati CE**  
**Air hydraulic trolley jacks EC certified**  
**Crics à chariot oléopneumatiques certifiés CE**

Codice Code Code	Descrizione Description Description	Portata tonnellate Capacity tons Capacité tonnes
3010041A	Cricco a carrello Trolley jack Cric à chariot	N10-3L 10-20-35
3010043A	Cricco a carrello Trolley jack Cric à chariot	N15-2L 15-30
3010043C	Cricco a carrello Trolley jack Cric à chariot	N15-2BL 15-30
3010046A	Cricco a carrello Trolley jack Cric à chariot	N15-4C 15-30-50-80
3010052	Cricco a carrello Trolley jack Cric à chariot	N20-3C 20-35-65
3010055	Cricco a carrello Trolley jack Cric à chariot	N35L 35
3010058	Cricco a carrello Trolley jack Cric à chariot	N30HC 30

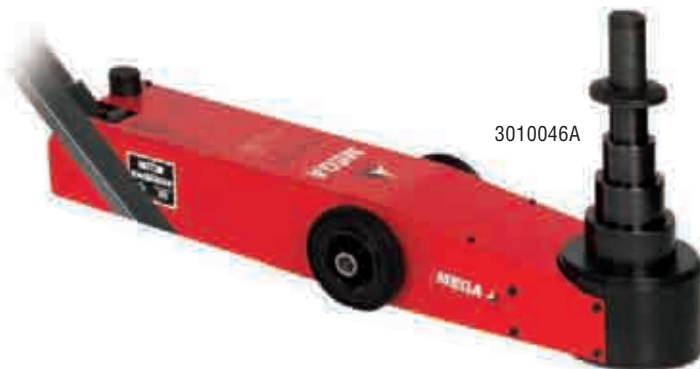

Capacity (t)	10-20-35	15-30	15-30	35	15-30-50-80	20-35-65	30
A	807	807	807	807	810	793	720
B	160	185	150	115	235	235	250
C	345	470	400	430	490	515	710
D	157	157	157	157	212	194	157
E	260	280	280	280	317	317	280
Weight (Kg)	41	46,5	43,5	52,5	70,5	69,5	78
Reference	N10-3L	N15-2L	N15-2BL	N35L	N15-4C	N20-3C	N30HC

# CRICCHI A CARRELLO

## TROLLEY JACKS

## CRICS À CHARIOT

**Cricchi a carrello oleopneumatici compatti certificati CE**  
**Air hydraulic compact trolley jacks EC certified**  
**Crics à chariot oléopneumatiques compact certifiés CE**

Codice Code Code	Descrizione Description Description	Portata tonnellate Capacity tons Capacité tonnes
3010060	Cricco a carrello Trolley jack Cric à chariot <b>NP15-2B</b>	15-30
3010060C	Cricco a carrello Trolley jack Cric à chariot <b>N15-2C</b>	15-30
3010060F	Cricco a carrello Trolley jack Cric à chariot <b>N15-2BC</b>	15-30
3010060L	Cricco a carrello Trolley jack Cric à chariot <b>N35-C</b>	35
3010060P	Cricco a carrello Trolley jack Cric à chariot <b>N25</b>	25

Nota: Migliore manovrabilità grazie alle dimensioni compatte

Note: Improved handling thanks to compact size

Note: Manoeuvrabilité améliorée grâce aux dimensions compactes



3010060



3010060C

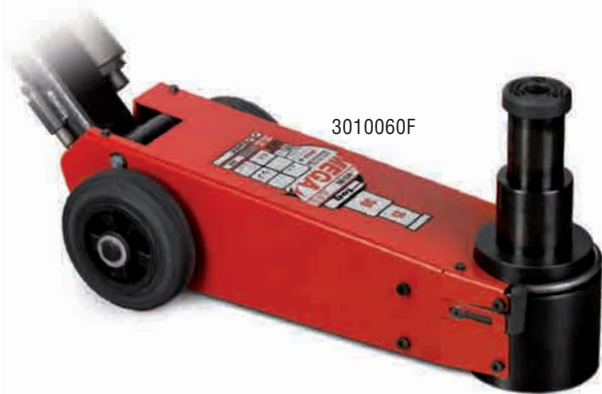

3010060F



3010060L



3010060P

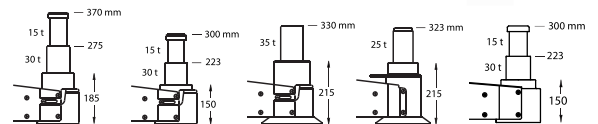

Capacity (t)	15-30	15-30	35	25	15-30
A	600	600	600	560	518
B	185	150	115	108	150
C	470	400	430	423	400
D	157	157	157	157	154
E	280	280	280	280	253
Weight (Kg)	45	42	51	47	31
Reference	<b>N15-2C</b>	<b>N15-2BC</b>	<b>N35C</b>	<b>N25</b>	<b>N15-2B</b>

# PIATTAFORME, TAVOLI E CUSCINI DI SOLLEVAMENTO

## LIFTING PLATFORMS, TABLES AND PADS

## PLATE-FORMES, TABLES ET COUSSINS DE LEVAGE

italmatic



3010080



3010094

Codice Code Code	Descrizione Description Description	Portata kg Capacity kg Capacité kg
3010080	Piattaforma pneumatica per motocicli <b>PTM-2</b> <i>Pneumatic platform for motorcycles</i> <i>Plate-forme pneumatique pour motocycles</i>	450
3010090	Tavolo di sollevamento idraulico <b>ME-650</b> <i>Hydraulic lifting table</i> <i>Table hydraulique de levage</i>	650
3010091	Tavolo di sollevamento idraulico <b>MEP-650</b> <i>Hydraulic lifting table</i> <i>Table hydraulique de levage</i>	650
3010092	Tavolo di sollevamento idraulico <b>ME-1200</b> <i>Hydraulic lifting table</i> <i>Table hydraulique de levage</i>	1200
3010093	Tavolo di sollevamento idraulico <b>ME-1500</b> <i>Hydraulic lifting table</i> <i>Table hydraulique de levage</i>	1500
3010094	Tavolo di sollevamento idraulico <b>ME-2500</b> <i>Hydraulic lifting table</i> <i>Table hydraulique de levage</i>	2500

Codice Code Code	Descrizione Description Description	Portata tonnellate Capacity tons Capacité tonnes
3010098	Cuscino sollevatore pneumatico (ideale per carrelli elevatori) <i>Pneumatic lifting pad (ideal for forklifts)</i> <i>Coussin de levage pneumatique (idéal pour chariots élévateurs)</i> L90 x W60 x H12/40 4,8 Bar	20



3010098

Codice Code Code	Descrizione Description Description
3010095	Ganasce fissaggio motocicli per piattaforma PTM-2 (opzionale) <i>Fixing jaws for motorcycles for platform PTM-2 (optional)</i> <i>Mâchoires de fixation motocycles pour plate-forme PTM-2 (option)</i>
3010096	Filtro aria regolatore e lubrificatore (opzionale) <i>Adjusting and lubricating air filter (optional)</i> <i>Filtre air de réglage et lubrification (option)</i>



Capacity (t)	650	650	1200	1500	2500
A	320	215	250	210	300
B	755	645	840	880	880
C	830	830	1020	1020	1060
D	500	500	500	500	540
E	1060	1060	1380	1380	1440
F	645	645	690	690	795
Weight (Kg)	45	42	51	47	31
Reference	MEP-650	ME-650	ME-1200	ME-1500	ME-2500

3010095



3010096





**TAMPONI IN GOMMA PER PONTI SOLLEVATORI**  
**RUBBER PADS FOR AUTO LIFTS**  
**TAMPONS EN CAOUTCHOUC POUR PONTS ÉLEVATEURS**



**Tamponi in gomma per ponti sollevatori**  
**Rubber pads for auto lifts**  
**Tampons en caoutchouc pour ponts éleveurs**

Codice Code Code	Descrizione Description Description	Misure (mm) Sizes (mm) - Dimensions (mm)			Pz. / scatola Pcs. / box Pcs. / boîte
		A	B	C	
3010200	Tamponi per ponti sollevatori Pads for auto lifts Tampons pour ponts éleveurs	160	120	20	50
3010201	Tamponi per ponti sollevatori Pads for auto lifts Tampons pour ponts éleveurs	160	120	30	32
3010201A	Tamponi per ponti sollevatori Pads for auto lifts Tampons pour ponts éleveurs	160	120	35	32
3010202	Tamponi per ponti sollevatori Pads for auto lifts Tampons pour ponts éleveurs	160	120	40	28
3010203	Tamponi per ponti sollevatori Pads for auto lifts Tampons pour ponts éleveurs	160	120	60	20
3010204	Tamponi per ponti sollevatori Pads for auto lifts Tampons pour ponts éleveurs	160	120	70	16
3010205	Tamponi per ponti sollevatori Pads for auto lifts Tampons pour ponts éleveurs	160	120	80	14
3010205A	Tamponi per ponti sollevatori Pads for auto lifts Tampons pour ponts éleveurs	160	120	100	10
3010206	Tamponi per ponti sollevatori Pads for auto lifts Tampons pour ponts éleveurs	160	120	120	10

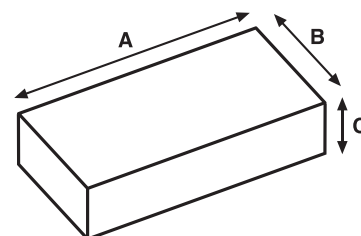

**TAMPONI IN GOMMA PER PONTI SOLLEVATORI**  
**RUBBER PADS FOR AUTO LIFTS**  
**TAMPONS EN CAOUTCHOUC POUR PONTS ÉLEVATEURS**

**italmatic**



3010206A



3010206B



3010206C



3010206D



3010206E



3010206F

**Tamponi in gomma rotondi per ponti sollevatori**  
**Round rubber pads for auto lifts**  
**Tampons en caoutchouc ronds pour ponts éleveurs**

<b>Codice</b> Code Code	<b>Descrizione</b> Description Description	<b>Ø est./out./ext. mm</b>	<b>Ø int./ins./int. mm</b>	<b>Ø centraggio mm</b> Centering Ø mm Ø de centrage mm	<b>Spessore mm</b> Thickness mm Épaisseur mm	<b>N. pioli</b> N. stakes N. piquets
<b>3010206A</b>	Tamponi rotondi con pioli Round pads with stakes Tampons ronds avec piquets	119	110	-	27	3 maschio 3 male 3 male
<b>3010206B</b>	Tamponi rotondi con pioli Round pads with stakes Tampons ronds avec piquets	140	133	54	27	3 maschio 3 male 3 male
<b>3010206C</b>	Tamponi rotondi con pioli Round pads with stakes Tampons ronds avec piquets	147	135	-	27	3 maschio 3 male 3 male
<b>3010206D</b>	Tamponi rotondi Round pads Tampons ronds	124	108	-	25	-
<b>3010206E</b>	Tamponi rotondi Round pads Tampons ronds	145	-	50/12	25	-
<b>3010206F</b>	Tamponi rotondi Round pads Tampons ronds	150	129	-	25	-

**TAMPONI PER STAZIONAMENTO**  
**PADS FOR PARKING**  
**TAMPONS POUR STATIONNEMENT**

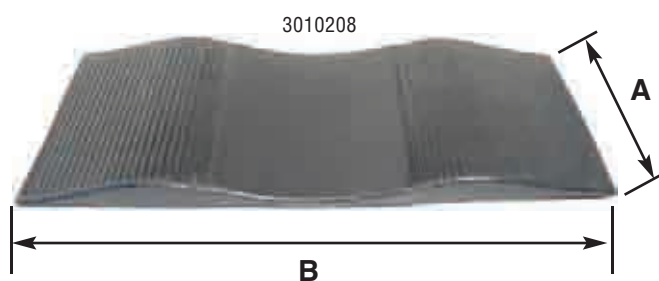
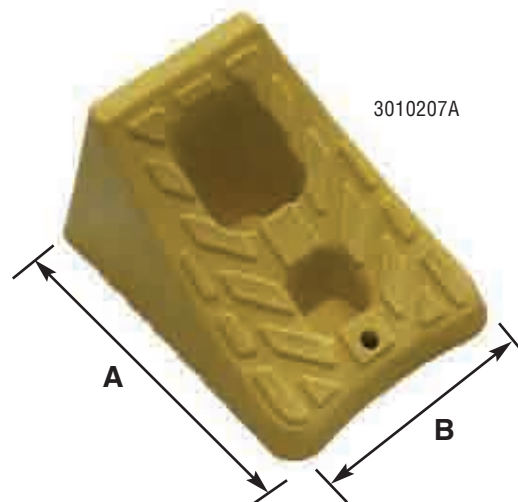
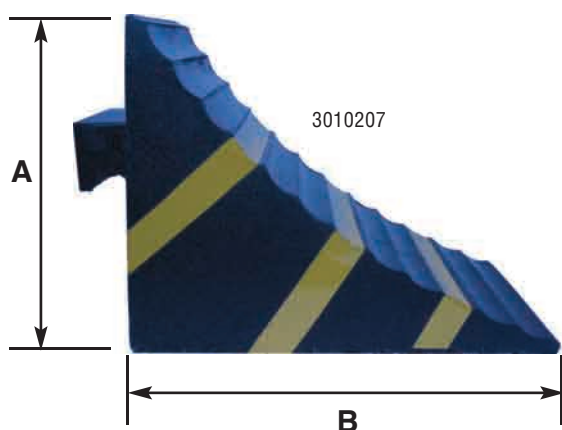

**Tamponi per stazionamento**  
**Pads for parking**  
**Tampons pour stationnement**

Codice Code Code	Descrizione Description Description	Misure (mm) Sizes (mm) - Dimensions (mm)	
		A	B
3010207	Tamponi per stazionamento Pads for parking Tampons pour stationnement	190	250
3010207A	Tamponi per stazionamento in plastica gialla per auto Pads for parking in yellow plastic for car Tampons en plastique jaune pour stationnement pour voiture	210	150
3010208	Tamponi per stazionamento Altezza min. 10 altezza max. 30 Pads for parking Min. height 10 max. height 30 Tampons pour stationnement Hauteur min. 10 hauteur max. 30	270	570

**RUOTE PER PICCOLI CARRELLI E CARRIOLE**  
**TYRES FOR SMALL TROLLEYS AND BARROWS**  
**PNEUS POUR PETIT CHARIOTS ET BROUETTES**

italmatic



3010220



3010222



3010224

**Ruote antiforatura per piccoli carrelli**  
**Solid tyres for small trolleys**  
**Pneus pleins pour petits chariots**

Codice Code Code	Descrizione Description Description	Ø mm Ø mm Ø mm	Battistrada mm Tread mm Chape mm	Nucleo Core Noyau	Foro Hole Forure	Battistrada Tread Chape
3010220	10" x 3.00 - 4	263	73	20 mm plastica 20 mm plastic 20 mm plastique	Passante Passing through Passant	Scolpito Grooved Sculpté
3010222	10" x 3.00 - 4	263	73	20 mm plastica 20 mm plastic 20 mm plastique	Rullini Rollers Rouleaux	Scolpito Grooved Sculpté
3010224	10" x 3.00 - 4	263	73	20 mm lamiera verniciata 20 mm painted sheet metal 20 mm entôle peinte	Rullini Rollers Rouleaux	Scolpito Grooved Sculpté



3010227



3010229



3010231

**Ruote pneumatiche per piccoli carrelli**  
**Tyres for small trolleys**  
**Pneus pour petits chariots**

Codice Code Code	Descrizione Description Description	Ø mm Ø mm Ø mm	Battistrada mm Tread mm Chape mm	Nucleo Core Noyau	Foro Hole Forure	Tele Plies Toiles	Battistrada Tread Chape
3010227	10" x 3.00 - 4	260	85	20 mm plastica 20 mm plastic 20 mm plastique	Passante Passing through Passant	2	Scolpito Grooved Sculpté
3010229	10" x 3.00 - 4	260	85	20 mm plastica 20 mm plastic 20 mm plastique	Rullini Rollers Rouleaux	4	Scolpito Grooved Sculpté
3010231	10" x 3.00 - 4	260	85	20 mm lamiera verniciata 20 mm painted sheet metal 20 mm entôle peinte	Rullini Rollers Rouleaux	4	Scolpito Grooved Sculpté

# RUOTE PER PICCOLI CARRELLI E CARRIOLE

## TYRES FOR SMALL TROLLEYS AND BARROWS

### PNEUS POUR PETIT CHARIOTS ET BROUETTES



3010235  
3010240



3010237  
3010242



3010244

### Ruote antiforatura per carriole

#### Solid tyres for wheel barrows - Pneus pleins pour brouettes

Codice Code Code	Descrizione Description Description	Ø mm Ø mm Ø mm	Battistrada mm Tread mm Chape mm	Nucleo Core Noyau	Perno mm Hole mm Goujon mm	Tele Plies Toiles	Battistrada Tread Chape
3010235	14" x 3.50 - 8	360	85	12 mm lamiera verniciata 12 mm painted sheet metal 12 mm entôle peinte	12 x 200	-	Rigato Rifled Rayé
3010237	16" x 4.00 - 8	400	100	12 mm lamiera verniciata 12 mm painted sheet metal 12 mm entôle peinte	12 x 200	-	Rigato Rifled Rayé

Nota: Fornite complete di perno e dadi - Note: Supplied complete with pin and nuts - Note: Fournis complets de goujon et écrous

### Ruote pneumatiche per carriole

#### Tyres for wheel barrows - Pneus pour brouettes

Codice Code Code	Descrizione Description Description	Ø mm Ø mm Ø mm	Battistrada mm Tread mm Chape mm	Nucleo Core Noyau	Perno mm Pin Goujon	Tele Plies Toiles	Battistrada Tread Chape
3010240	14" x 3.50 - 8	360	85	12 mm lamiera verniciata 12 mm painted sheet metal 12 mm entôle peinte	12 x 200	2	Rigato Rifled Rayé
3010242	16" x 4.00 - 8	400	100	12 mm lamiera verniciata 12 mm painted sheet metal 12 mm entôle peinte	12 x 200	2	Rigato Rifled Rayé
3010244	14" x 3.50 - 8	360	85	12 mm lamiera verniciata 12 mm painted sheet metal 12 mm entôle peinte	12 x 200	2	Scolpito Grooved Sculpté

Nota: Fornite complete di perno e dadi - Note: Supplied complete with pin and nuts - Note: Fournis complets de goujon et écrous



3010248



3010250

### Set copertone con camera d'aria

#### Tire set with air tube

#### Jeu pneu avec chambre à air

Codice Code Code	Descrizione Description Description	Tele Plies Toiles	Valvola Valve Valve	Nota Note Note
3010248	3.50 - 8	2	TR413	Ricambio per codice 3010240 Spare part for code 3010240 Pièce de rechange pour code 3010240
3010249	4.00 - 8	4	TR413	Ricambio per codice 3010242 Spare part for code 3010242 Pièce de rechange pour code 3010242
3010250	3.00 - 4	4	DIN7777	Ricambio universale per codici 3010227, 3010229, 3010231 Universal spare part for codes 3010227, 3010229, 3010231 Pièce de rechange universelle pour codes 3010227, 3010229, 3010231



3020001



3020002



3020003



3020004

**Vulcanizzatori**  
**Vulcanizers**  
**Vulcanisateurs**

Codice Code Code	Riferimento Reference Référence	Peso kg Weight kg Poids kg	Dimensioni macchina cm Machine sizes cm Dimensions machine cm	Dimensioni piastra mm Heating unit sizes mm Dimensions plaque chauffante mm	volt	W	Hz	bar
3020001	M10	7,550	40 x 20 x 51	190 x 100	230	600	50/60	
3020002	P20	26,250	49 x 20 x 92	190 x 100	230	600	50/60	10
3020003	P40	29,400	49 x 20 x 100	190 x 100	230	1200	50/60	10
3020004	M50	29,400	63 x 20 x 98	190 x 100	230	1200	50/60	
3020005	M50L	31,000	63 x 20 x 98	220 x 145	230	1200	50/60	

**Accessori**  
**Accessories**  
**Accessoires**

Codice Code Code	Descrizione Description Description	M 10	P 20	P 40	M 50	M 50 L
3020007	Sacchetto compensatore - <i>Adjusting bag - Sac compensateur</i>		●	●	●	●
3020008	Supporto orientabile - <i>Swinging support - Support orientable</i>		●	●	○	○
3020009	Colonna di supporto - <i>Support pillar - Colonne de support</i>	○	○	○	○	○
3020010	Mobiletto di supporto - <i>Support cabinet - Cabine de support</i>	○	○	○	○	○
3020011	Piatto appoggio - <i>Supporting plate - Plaque de support</i>	●	●	●	●	●
3020012	Piastra per sede valvola - <i>Heating unit with valve slot Plaque avec siège pour valve</i>		○	○	○	○
3020013	Piastra maggiorata - <i>Over-powered heating unit - Plaque majorée</i>		○	○	○	○
3020014	Comando a pedale - <i>Pedal control - Contrôle à pédale</i>		○	○		
3020015	Supporto di fissaggio - <i>Fixing plate - Plaque de fixation</i>				●	●
3020016	Dispositivo cont. reg. press. - <i>Pressure adjusting device Dispositif réglage pression</i>		○	●		
3020017	Piastra riscaldamento 110 V - <i>Heating unit 110 V - Plaque chauffante 110 V</i>	○	○	○	○	○

● In dotazione - *Standard - Standard*

○ A richiesta - *Upon request - Sur demande*

# VULCANIZZATORI PER PNEUMATICI OTR

## OTR TYRE VULCANIZERS

### VULCANISATEURS POUR PNEUS OTR



3020052

<b>Codice</b> <i>Code</i> <i>Code</i>	<b>Descrizione</b> <i>Description</i> <i>Description</i>	<b>Area di riparazione</b> <i>Area of repairing</i> <i>Zone de réparation</i>	<b>Dimensione pneumatico</b> <i>Tyre size</i> <i>Dimension pneu</i>
<b>3020050</b>	Sistema di vulcanizzazione di riparazione pneumatici radiali OTR <i>Curing system for OTR radial tyre repairing</i> <i>Système de vulcanisation pour réparation pneus radiaux OTR</i>	Tallone <i>Bead</i> <i>Talon</i>	Da 40.00-57 a 59/85-63 <i>From 40.00-57 to 59/85-63</i> <i>De 40.00-57 à 59/85-63</i>
<b>3020051</b>	Sistema di vulcanizzazione di riparazione pneumatici OTR extra large <i>Curing system for OTR extra large tyre repairing</i> <i>Système de vulcanisation pour réparation pneus OTR extra large</i>	Fianco <i>Sidewall</i> <i>Flanc</i>	Da 40.00-57 a 55/85-63 <i>From 40.00-57 to 55/85-63</i> <i>De 40.00-57 à 55/85-63</i>
<b>3020052</b>	Sistema di vulcanizzazione di riparazione pneumatici OTR <i>Curing system for OTR tyre repairing</i> <i>Système de vulcanisation pour réparation pneus OTR</i>	Tutte <i>All</i> <i>Toutes</i>	Da 13.00 a 55.5/85-63 incluso pneumatici a profilo basso, radiali e diagonali <i>From 13.00 to 55.5/85-63 including low profile, radial and cross ply</i> <i>De 13.00 à 55.5/85-63 en incluant pneus à profil bas, radiaux et diagonaux</i>

Per consentire una corretta configurazione e quotazione del sistema, specificare sempre al momento dell'ordine:

- gamma pneumatici di massime dimensioni (radiali e diagonali)
- gamma pneumatici di minime dimensioni (radiali e diagonali)

*To allow the proper system configuration and quotation, always specify in the order:*

- full range of larger tyres (radial / cross ply)
- full range of smaller tyres (radial / cross ply)

*Pour permettre une configuration et une offre correctes du système, spécifier toujours au moment de la commande:*

- gamme de pneus de dimensions max (radiaux et diagonaux)
- gamme de pneus de dimensions min. (radiaux et diagonaux)

#### SISTEMA DI VULCANIZZAZIONE UNIVERSALE PNEUMATICI OTR

- Il sistema di riparazioni universale OTR è in grado di coprire l'intera gamma di pneumatici OTR ed è caratterizzato dalla possibilità di essere gradualmente esteso fino alle sezioni 55 / 85-63.
- I cuscinetti flessibili riscaldanti si adattano perfettamente al profilo di tutte le tipologie di pneumatici OTR evitando imperfezioni della riparazione.
- Il sistema supporta l'utilizzo di rappezi diagonali fino a 30" x 30" e radiali fino a 35" x 10". Su richiesta sono disponibili componenti per la vulcanizzazione di rappezi di dimensioni maggiori.
- Dispone di un pannello di controllo con display digitale della temperatura, controllo temporizzato della pressione, misuratore della pressione e dispositivo di sicurezza.
- Il sistema è leggero e trasportabile.

#### UNIVERSAL VULCANIZING SYSTEM FOR OTR TYRES

- The universal OTR Tyre Repair system fits with a full range of OTR tyres and can be gradually extended when required to cover up to 55 / 85-63 sections.
- Flexible rubber heatpads and airbags conform to the profile of all type of OTR tyres, providing distortion free repairs.
- Handles up to a 30" x 30" cross ply patch and a 35" x 10" radial patch. Components to cover larger patch sizes can be supplied on request.
- Control panel fitted with digital temperature displays, air pressure control timer, air gauges and fail safe features.
- The system is lightweight and portable.

#### SYSTÈME DE VULCANISATION UNIVERSEL POUR PNEUS OTR

- Le système de réparation universel OTR peut couvrir la gamme complète de pneus OTR et il peut être étendu graduellement jusqu'aux sections 55 / 85-63.
- Les roulements flexibles chauffant s'adaptent parfaitement au profil de tous types de pneus OTR en évitant des imperfections de la réparation.
- Le système supporte l'utilisation des emplâtres diagonaux jusqu'à 30" x 30" et radiaux jusqu'à 35" x 10". Sur demande des composants pour la vulcanisation d'emplâtres de dimensions plus grandes sont disponibles.
- Il a un tableau de contrôle avec display digital de la température, contrôle temporisé de la pression, mesureur de la pression et dispositif de sécurité.
- Le système est léger et transportable.



3030001

**Rigatore  
Groover  
Sculpteur**

<b>Codice</b> <i>Code</i> <i>Code</i>	<b>Descrizione</b> <i>Description</i> <i>Description</i>	<b>Tensione</b> <i>Tension</i> <i>Tension</i>
<b>3030001</b>	Rigatore / Groover / Sculpteur - Rillfit SIX	230-240V
<b>3030001A</b>	Rigatore / Groover / Sculpteur - Rillfit SIX	115V

**Ricambi ed accessori / Spares and accessories / Pièces de rechange et accessoires**

<b>Codice</b> <i>Code</i> <i>Code</i>	<b>Descrizione</b> <i>Description</i> <i>Description</i>	<b>Riferimento</b> <i>Reference</i> <i>Référence</i>
<b>3030005</b>	Cavo resistenza Rillfit SIX <i>Heating element Rillfit SIX / Résistance électrique Rillfit SIX</i>	1550174
<b>3030006</b>	Testa porta lame completa <i>Complete blades supporting group</i> <i>Groupe complet supportant les lames</i>	1560001
<b>3030007</b>	Coppia testine <i>Pair of guides / Paire de guides</i>	1460001 1460002
<b>3030008</b>	Coppia viti per testine <i>Pair of screws for guides / Paire de vis pour guides</i>	1700162
<b>3030009</b>	Coppia scorrevoli posteriori <i>Pair of back sliding blocks</i> <i>Paire de blocs coulissants postérieurs</i>	1200035
<b>3030010B</b>	Selettore rotativo con manopola Rillfit SIX <i>Rotary selector with handle Rillfit SIX</i> <i>Sélecteur rotatif avec poignée Rillfit SIX</i>	1400103 1400045
<b>3030011</b>	Impugnatura nuda Rillfit SIX <i>Bare handle Rillfit SIX / Poignée nue Rillfit SIX</i>	1400041 1400042
<b>3030012</b>	Cassa trasformatore Rillfit IV <i>Transformer frame Rillfit IV</i> <i>Structure du transformateur Rillfit IV</i>	-
<b>3030012B</b>	Cassa trasformatore con maniglia Rillfit SIX <i>Transformer frame with handle Rillfit SIX</i> <i>Structure du transformateur avec poignée Rillfit SIX</i>	1400043 1400044
<b>3030013</b>	Trasformatore Rillfit IV <i>Transformer Rillfit IV / Transformateur Rillfit IV</i>	-
<b>3030013B</b>	Trasformatore Rillfit SIX <i>Transformer Rillfit SIX / Transformateur Rillfit SIX</i>	1560005
<b>3030015</b>	Supporto per ruota da scolpire <i>Stand for tyre to be grooved</i> <i>Support pour pneu à sculpter</i>	-
<b>3030015A</b>	Supporto per ruota da scolpire automatico <i>Automatic stand for tyre to be grooved</i> <i>Support automatique pour pneu à sculpter</i>	-



3030006



3030007



3030009



3030010B



3030011



3030012B



3030013



3030013B



3030015





3030002A



3030003A



3030004

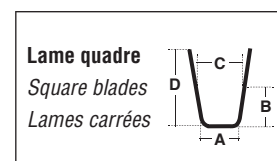
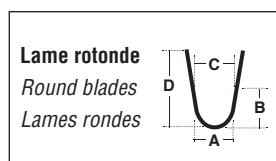

**Lame per rigatore Rillfit - Blades for Rillfit groover - Lames pour sculpteur Rillfit**

Codice Code Code	Descrizione Description Description	A	B	C	D	N.lame per confezione N° of blades per box N° de lames par boîte
		Largh. taglio infer. Lower cut width Largeur coupe inf.	Profond. di taglio Cut depth Profond. coupe	Largh. taglio super. Upper cut width Largeur coupe sup.	Profond. lama Blade depth Profond. lame	
3030002A	Lame tonde R1 Round blades R1 Lames rondes R1	3 mm	7 mm	5 mm	21 mm	20
3030002B	Lame tonde R2 Round blades R2 Lames rondes R2	5 mm	7 mm	8 mm	21 mm	20
3030002C	Lame tonde R3 Round blades R3 Lames rondes R3	6 mm	10 mm	15 mm	23 mm	20
3030002D	Lame tonde R4 Round blades R4 Lames rondes R4	8 mm	12 mm	16 mm	25 mm	20
3030002E	Lame tonde R5 Round blades R5 Lames rondes R5	10 mm	12 mm	18 mm	24 mm	20
3030003A	Lame quadre W1 Square blades W1 Lames carrées W1	3 mm	7 mm	5 mm	21 mm	20
3030003B	Lame quadre W2 Square blades W2 Lames carrées W2	5 mm	7 mm	6 mm	21 mm	20
3030003C	Lame quadre W3 Square blades W3 Lames carrées W3	7 mm	10 mm	10 mm	22 mm	20
3030003D	Lame quadre W4 Square blades W4 Lames carrées W4	9 mm	12 mm	13 mm	24 mm	20
3030003E	Lame quadre W5 Square blades W5 Lames carrées W5	11 mm	12 mm	15 mm	23 mm	20
3030004	Lame quadre giganti W6 Large square blades W6 Lames carrées grandes W6	23 mm	12 mm	28 mm	24 mm	10

Nota: Altre lame disponibili su richiesta  
Note: Other blades available on request  
Note: Autres lames disponibles sur demande

**Caratteristiche del rigatore Rillfit SIX®  
Features of Rillfit SIX® groover  
Caractéristiques du sculpteur Rillfit SIX®**

**Il Rillfit SIX® è il prodotto ideale per i professionisti:**

- 1 Trasformatore toroidale Hi-Tech con interruttore termico per taglio non-stop sicuro e potente
- 2 Interruttore 4 livelli di potenza facile da visualizzare
- 3 Cavo speciale e rivestimento cavo per prevenire surriscaldamento
- 4 Cavo di connessione super flessibile
- 5 Nuovo led On/Off
- 6 Impugnatura ergonomica
- 7 Maggior protezione dal calore sulla testa dell'impugnatura
- 8 Maggior resistenza all'acqua del trasformatore
- 9 Certificato TUV & CE

**Rillfit SIX® is the ideal product for professional operators:**

- 1 Hi-Tech toroidal power transformer with thermo-switch for safe and powerful non-stop cutting
- 2 Easy to visualize 4 power steps switch
- 3 Special cable and cable cover to prevent overheating
- 4 Super flexible connection-cable
- 5 New On/Off led
- 6 Ergonomic handgrip
- 7 Increased heat protection on the handle head
- 8 More water resistant transformer casting
- 9 TUV & CE certificated

**Rillfit SIX® est le produit idéal pour les professionnels:**

- 1 Transformateur toroidal Hi-Tech avec interrupteur thermique pour coupe non-stop puissante et en sécurité
- 2 Interrupteur phases à 4 puissances facile à visualiser
- 3 Câble spécial et revêtement câble pour prévenir le surchauffage
- 4 Câble de connexion super flexible
- 5 Nouveau led On/Off
- 6 Poignée ergonomique
- 7 Protection de la chaleur augmentée sur la tête de la poignée
- 8 Résistance à l'eau du transformateur plus haute
- 9 Certifié TUV & CE

**Consigli per l'utilizzo - Suggestions for use - Recommandations d'emploi:**

- Rillfit SIX® è usato principalmente per intagliare i disegni del battistrada dei pneumatici;
- Non appena Rillfit SIX viene premuto contro il pneumatico da riscoprire, la lama si riscalda automaticamente. Per intagliare a zig-zag, si dovrà allentare la pressione mentre si gira la lama
- L'intaglio dovrà essere eseguito rapidamente. Gomma che brucia senza fiamma o presenza di fumo indicano che il taglio viene eseguito troppo lentamente o che la potenza è regolata troppo alta.

- Rillfit SIX® is mainly used for cutting tyres tread patterns;
- As Rillfit is pressed against the Tyre to be re-grooved, the blade is automatically heated. In order to cut zig-zag patterns, the pressure should be released while turning the blade;
- Cutting should be executed quickly. Smoke or smouldering rubber are indications that the cutting is being executed too slowly or that the power setting is too high.

- Rillfit SIX® est employé principalement pour sculpter les profils de la chape des pneus
- Dès que le Rillfit SIX fait pression contre le pneu à être sculpté, la lame chauffe automatiquement. Pour sculpter des profils zig-zag, on devra diminuer la pression tandis que la lame est tournée
- La coupe devra être faite rapidement; du caoutchouc qui brûle sans flamme ou la présence de fumée indiquent que la coupe est faite trop lentement ou que la puissance est réglée trop haute

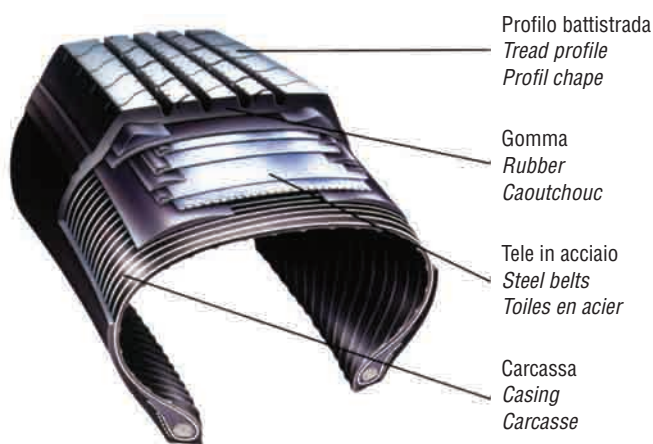

**DISPOSITIVI DI GONFIAGGIO OMOLOGATI CE**  
**INFLATING DEVICES CE HOMOLOGATED**  
**DISPOSITIFS DE GONFLAGE HOMOLOGUÉS CE**



3030016



3030017



3030016S



3030017A



3030017C



3030017B

Codice Code	Descrizione Description Description	Pressione Pressure Pression	Scala Scale Echelle
3030016	Pistola di gonfiaggio Eurodainu Wonder <i>Wonder Eurodainu inflating gun / Pistolet de gonflage Eurodainu Wonder</i>	0,7-12 bar	bar
3030016PSI	Pistola di gonfiaggio Eurodainu Wonder <i>Wonder Eurodainu inflating gun / Pistolet de gonflage Eurodainu Wonder</i>	0,7-12 bar	bar/psi
3030016S	Pistola di gonfiaggio Superdainu Wonder. Maniglia anticorrosione. Corona antishock <i>Wonder Superdainu inflating gun. Anti-corrosion handle. Anti-Shock crown</i> <i>Pistolet de gonflage Superdainu Wonder. Poignée anticorrosion. Couronne anti-choc</i>	0,7-10 bar	bar
3030016SPSI	Pistola di gonfiaggio Superdainu Wonder. Maniglia anticorrosione. Corona antishock <i>Wonder Superdainu inflating gun. Anti-corrosion handle. Anti-Shock crown</i> <i>Pistolet de gonflage Superdainu Wonder. Poignée anticorrosion. Couronne anti-choc</i>	0,7-10 bar	bar/psi
3030017	Pistola di gonfiaggio Eurodainu Schrader / <i>Schrader Eurodainu inflating gun / Pistolet de gonflage Eurodainu Schrader</i>	0,7-11 bar	bar
3030017PSI	Pistola di gonfiaggio Eurodainu Schrader / <i>Schrader Eurodainu inflating gun / Pistolet de gonflage Eurodainu Schrader</i>	0,7-11 bar	bar/psi
3030017A	Pistola di gonfiaggio professionale / <i>Professional inflating gun / Pistolet de gonflage professionnel</i>	0-10 bar	bar
3030017B	Pistola di gonfiaggio Command Air completa di attacco di gonfiaggio doppio e protezione tubo <i>Command Air inflating gun complete with double inflating connector and hose protection</i> <i>Pistolet de gonflage Command Air complet de connecteur de gonflage double et protection tuyau</i>	0-11 bar	bar/psi
3030017C	Pistola di gonfiaggio Mast'air tubo da 1,5 m / <i>Mast'air inflating gun hose of 1,5 m / Pistolet de gonflage Mast'air tuyau de 1,5 m</i>	0,7-12 bar	bar
3030017CPSI	Pistola di gonfiaggio Mast'air tubo da 1,5 m <i>Mast'air inflating gun hose of 1,5 m / Pistolet de gonflage Mast'air tuyau de 1,5 m</i>	0,7-12 bar	bar/psi



<b>Codice</b> <i>Code</i> <i>Code</i>	<b>Descrizione</b> <i>Description</i> <i>Description</i>	<b>Pressione</b> <i>Pressure</i> <i>Pression</i>	<b>Scala</b> <i>Scale</i> <i>Echelle</i>
<b>3030017E</b>	Pistola di gonfiaggio Airforce PCL / <i>Airforce PCL inflating gun</i> / <i>Pistolet de gonflage Airforce PCL</i>	0-12 bar	bar/psi
<b>3030017F</b>	Pistola di gonfiaggio digitale Accura 1 PCL / <i>Accura 1 PCL digital inflating gun</i> / <i>Pistolet de gonflage digital Accura 1 PCL</i>	0-12 bar	bar
<b>3030017FPSI</b>	Pistola di gonfiaggio digitale Accura 1 PCL / <i>Accura 1 PCL digital inflating gun</i> / <i>Pistolet de gonflage digital Accura 1 PCL</i>	0-174 psi	psi
<b>3030017G</b>	Pistola di gonfiaggio digitale Schrader Digit'Air <i>Schrader Digit'Air digital inflating gun</i> / <i>Pistolet de gonflage digital Schrader Digit'Air</i>	0.1-11 bar	bar
<b>3030017GPSI</b>	Pistola di gonfiaggio digitale Schrader Digit'Air <i>Schrader Digit'Air digital inflating gun</i> / <i>Pistolet de gonflage digital Schrader Digit'Air</i>	1.4-160 psi	psi
<b>3030017J</b>	Pistola di gonfiaggio digitale professionale, Ø 80mm, impugnatura gomma <i>Professional digital inflating gun, Ø80mm, rubber handle</i> <i>Pistolet de gonflage digital professionnel, Ø80mm, poignée en caoutchouc</i>	0-12 bar	bar/psi
<b>3030017K</b>	Pistola di gonfiaggio digitale professionale, Ø 63mm <i>Professional digital inflating gun, Ø63mm</i> <i>Pistolet de gonflage digital professionnel, Ø63mm</i>	0-12 bar	bar/psi
<b>3030018</b>	Tubo di ricambio per pistola Eurodainu Wonder (codice 3030016) e Superdainu (303016S), completo di raccordo <i>Spare hose for Eurodainu inflating gun (code 3030016) and Superdainu (303016S), c/w coupling</i> <i>Tuyau de rechange pour pistolet de gonflage Eurodainu (code 3030016) et Superdainu (303016S) avec raccord</i>	–	–
<b>3030018A</b>	Tubo di ricambio per pistole Eurodainu, Mast'air e Digit'air Schrader, completo di raccordo <i>Spare hose for Eurodainu, Mast'air and Digit'air Schrader inflating guns, c/w coupling</i> <i>Tuyau de rechange pour pistolets de gonflage Eurodainu, Mast'air et Digit'air Schrader, avec raccord</i>	–	–
<b>3030018D</b>	Manico di ricambio MK3 PCL / <i>Spare handle MK3 PCL</i> / <i>Poignée de rechange MK3 PCL</i>	–	–

**MISURATORI DI PRESSIONE OMOLOGATI CE**  
**PRESSURE MEASURERS EC HOMOLOGATED**  
**MESUREURS DE PRESSION HOMOLOGUÉS CE**



<b>Codice</b> Code Code	<b>Descrizione</b> Description Description	<b>Pressione</b> Pressure Pression
<b>3030019</b>	Manometro DAIRA con tubo di gomma flessibile da 50 cm DAIRA manometer c/w flexible rubber hose of 50 cm Manomètre DAIRA avec tuyau en caoutchouc flexible de 50 cm	0,7 - 12,0 bar
<b>3030019A</b>	Manometro professionale con tubo di gomma flessibile da 30 cm Professional manometer with flexible rubber hose of 30 cm. Manomètre professionnel avec tuyau flexible en caoutchouc de 30 cm	0 - 12,0 bar
<b>3030019B</b>	Misuratore di pressione Tyre Check PCL Tyre Check PCL pressure gauge Mesureur de pression Tyre Check PCL	0 - 12,0 bar
<b>3030019F</b>	Manometro professionale digitale con funzioni scarico Professional digital gauge with release function Manomètre digital professionnel avec fonction de purge	0 - 12,0 bar
<b>3030020</b>	Tubo di ricambio per DAIRA Spare hose for DAIRA Tuyau de rechange pour DAIRA	-
<b>3030021A</b>	Manometro analogico Quicker Quicker analogic gauge Manomètre analogique Quicker	0,7 - 4,3 bar
<b>3030022A</b>	Manometro digitale PCL completo di dispositivo per misurazione profondità battistrada (0-16 mm) e luce PCL digital gauge complete with tread depth gauge device (0-16 mm) and light Manomètre digital PCL complet de dispositif pour la mesuration de la profondeur de la chape (0-16 mm) et lumière	0,15 - 7,0 bar



3030022C



3030022E



3030022J



3030022G



3030022K



3030022M

<b>Codice</b> Code Code	<b>Descrizione</b> Description Description	<b>Pressione</b> Pressure Pression
<b>3030022C</b>	Manometro digitale (tripla scala bar, psi, kpa) Digital gauge (triple scale bar, psi, kpa) Manomètre digital (échelle triple bar, psi, kpa)	0 - 10,0 bar
<b>3030022E</b>	Misuratore digitale battistrada (0-15mm) & pressione pneumatico (tripla scala bar, psi, kpa) - Schrader 66185-67 Digital tread depth (0-15mm) & tire pressure gauge (triple scale bar, psi, kpa) - Schrader 66185-67 Jauge d'usure (0-15mm) & controleur de pression électronique (échelle triple bar, psi, kpa) - Schrader 66185-67	0,35 - 6,8 bar
<b>3030022G</b>	Misuratore di pressione pneumatici programmabile (bar, psi) Michelin 66126-67 Programmable digital tire pressure gauge Michelin 66126-67 Manomètre numérique programmable pour pneus (bar, psi) Michelin 66126-67	0,35 - 7 bar
<b>3030022J</b>	Misuratore di pressione pneumatici programmabile (bar, psi) Michelin 66127-67 Programmable digital tire pressure gauge Michelin 66127-67 Manomètre numérique programmable pour pneus (bar, psi) Michelin 66127-67	0,35 - 7 bar
<b>3030022K</b>	Misuratore di pressione Schrader digitale (Schrad'digital 60226-67) Schrader digital tire pressure gauge (Schrad'digital 60226-67) Manomètre numérique Schrader (Schrad'digital 60226-67)	0,35 - 10 bar
<b>3030022M</b>	Misuratore di pressione Schrader digitale (Moto 65044-67) Schrader digital tire pressure gauge (Moto 65044-67) Manomètre numérique Schrader (Moto 65044-67)	0,35 - 7 bar

# DISPOSITIVI DI GONFIAGGIO AUTOMATICI ARIA E AZOTO

## AUTOMATIC AIR AND NITROGEN INFLATION DEVICES

### DISPOSITIFS DE GONFLAGE AUTOMATIQUES AIR ET AZOTE



3030023



3030023B

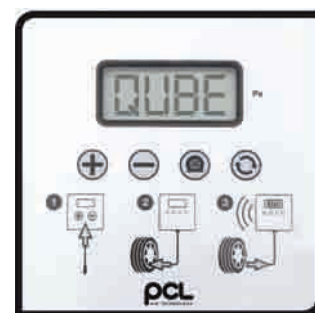

3030024

### Dispositivi a parete

### Wall devices

### Dispositifs pour montage sur mur

Codice Code Code	Descrizione Description Description	Pressione Max Max. pressure Pression Max
3030023	Dispositivo automatico per il gonfiaggio dei pneumatici. È sufficiente impostare la pressione desiderata ed il dispositivo provvede automaticamente al gonfiaggio. Dotato di tubo da 7,6 m ed attacco singolo a scatto. <i>Automatic device to inflate tyres. It is enough to set the desired pressure and the device inflates automatically.</i> <i>Equipped with hose of 7,6 m and single snap-in connector.</i> <i>Dispositif automatique pour le gonflage des pneus.</i> <i>Il est assez d'établir la pression désirée et le dispositif effectuera le gonflage automatiquement.</i> <i>Il est équipé de tuyau de 7,6 m et de connecteur individuel à déclenchement.</i>	10 bar
3030023A	Dispositivo automatico per il gonfiaggio dei pneumatici. È sufficiente impostare la pressione desiderata ed il dispositivo provvede automaticamente al gonfiaggio. Dotato di tubo da 7,6 m ed attacco singolo a scatto. <i>Automatic device to inflate tyres. It is enough to set the desired pressure and the device inflates automatically.</i> <i>Equipped with hose of 7,6 m and single snap-in connector.</i> <i>Dispositif automatique pour le gonflage des pneus.</i> <i>Il est assez d'établir la pression désirée et le dispositif effectuera le gonflage automatiquement.</i> <i>Il est équipé de tuyau de 7,6 m et de connecteur individuel à déclenchement.</i>	22 bar
3030023B	Dispositivo automatico per il gonfiaggio dei pneumatici. Inoltre, consente in modo totalmente automatico di togliere l'aria dal pneumatico ed immettere azoto fino alla pressione desiderata, senza la necessità di smontare il pneumatico, dotato di tubo da 7,6 m ed attacco singolo a scatto. <i>Automatic device to inflate tyres. Moreover, it allows in a completely automatic mode to take away the air from the tyre and to put in nitrogen up to the desired pressure, without needing to demount the tyre, equipped with hose of 7,6 m and single snap-in connector.</i> <i>Dispositif automatique pour le gonflage des pneus.</i> <i>En outre, il permet d'une façon complètement automatique d'enlever l'air du pneu et d'introduire azote jusqu'à la pression désirée, sans besoin de démonter le pneu, équipé de tuyau de 7,6 m et de connecteur individuel à déclenchement.</i>	10 bar
3030024	Accura QUBE - Unità compatta (150x150mm) per gonfiare in automatico fino alla pressione desiderata con aria o azoto, con funzione "overpressure". Dotato di tubo da 5m con attacco singolo a scatto. <i>Accura QUBE- Compact unit (150x150mm) to inflate automatically up to the desired pressure by air or nitrogen, with "overpressure" function. Equipped with hose of 5 mt with single snap-in connector</i> <i>Accura QUBE – unité compacte (150x150mm) pour gonfler en automatique jusqu'à la pression désirée par air ou azote, avec fonction de "surpression". Equipée de tuyau à 5mt avec connexion individuelle à détente</i>	10 bar

### Accessori

### Accessories

### Accessoires

Codice Code Code	Descrizione Description Description
3030024A	Piedistallo / Pedestal / Piédestal
3030024B	Controllo pressione remoto / Remote pressure control / Contrôle reculé pression
3030024C	Attacco gemellato doppio a scatto / Double twin snap-in connector / Connecteur double jumelé à déclenchement

# DISPOSITIVI DI GONFIAGGIO AUTOMATICI ARIA E AZOTO

AUTOMATIC AIR AND NITROGEN INFLATION DEVICES

DISPOSITIFS DE GONFLAGE AUTOMATIQUES AIR ET AZOTE

italmatic



3030024H



3030024K



3030024S

## Dispositivi mobili Movable devices Dispositifs mobiles

Codice Code Code	Descrizione Description Description	Note Note Note
3030024H	Generatore mobile di azoto con tanica 50 lt <i>Movable nitrogen generator with tank of 50 lt</i> <i>Générateur mobile d'azote avec bidon à 50 lt</i>	-
3030024K	Generatore mobile di azoto con tanica 50 lt e dispositivo di gonfiaggio automatico fino a 4 pneumatici <i>Movable nitrogen generator with tank of 50 lt and automatic inflation device up to 4 tyres</i> <i>Générateur mobile d'azote avec bidon à 50 lt et dispositif de gonflage automatique jusqu'à 4 pneus</i>	Dotata di 4 tubi da 7,6mt con attacco singolo a scatto <i>Equipped with 4 hoses of 7,6mt with single snap-in connector</i> <i>Équipé de 4 tuyaux à 7,6mt avec connecteur individuel à détente</i>
3030024S	Strumento analizzatore della percentuale di azoto contenuta nel pneumatico. <i>Instrument to examine the percentage of nitrogen contained in the tyre</i> <i>Instrument pour analyser le pourcentage d'azote contenu dans le pneu</i>	L'utilizzo di una percentuale di azoto di almeno 95% ottimizza le prestazioni del pneumatico. <i>The use of a nitrogen percentage of at least 95% optimizes the tyre performances</i> <i>L'utilisation d'un pourcentage d'azote d'au moins 95% optimise les performances du pneu</i>



**Tubi aria - Air hoses - Tuyaux air**

<b>Codice</b> Code Code	<b>Descrizione</b> Description Description	<b>Diametro</b> Diameter Diamètre	<b>Lunghezza</b> Length Longueur
3030024TA	Tubo spirale 5 m con attacco baionetta Spiral hose 5 m with bayonet coupling Tuyau spiral 5 m avec joint à baïonnette	6 x 8	5 m
3030024TB	Tubo spirale 10 m con attacco baionetta Spiral hose 10 m with bayonet coupling Tuyau spiral 10 m avec joint à baïonnette	6 x 8	10 m
3030024TC	Tubo spirale 15 m con attacco baionetta Spiral hose 15 m with bayonet coupling Tuyau spiral 15 m avec joint à baïonnette	6 x 8	15 m
3030024TD	Tubo spirale 5 m con attacco rapido Spiral hose 5 m with quick connector Tuyau spiral 5 m avec connecteur rapide	6 x 8	5 m
3030024TE	Tubo spirale 10 m con attacco rapido Spiral hose 10 m with quick connector Tuyau spiral 10 m avec connecteur rapide	6 x 8	10 m
3030024TF	Tubo spirale 15 m con attacco rapido Spiral hose 15 m with quick connector Tuyau spiral 15 m avec connecteur rapide	6 x 8	15 m
3030024TG	Tubo spirale Rilsan 5 m con rubinetto rapido universale Spiral hose Rilsan 5 m with universal quick tap Tuyau spiral en Rilsan 5 m avec robinet rapide universel	6 x 8	5 m
3030024TH	Tubo spirale Rilsan 10 m con rubinetto rapido universale Spiral hose Rilsan 10 m with universal quick tap Tuyau spiral en Rilsan 10 m avec robinet rapide universel	6 x 8	10 m
3030024TJ	Tubo spirale Rilsan 15 m con rubinetto rapido universale Spiral hose Rilsan 15 m with universal quick tap Tuyau spiral en Rilsan 15 m avec robinet rapide universel	6 x 8	15 m
3030024TK	Tubo spirale in poliuretano 4 m con rubinetto rapido universale Polyurethane spiral hose 4 m with universal rapid tap Tuyau spiral en polyuréthane 4 m avec robinet rapide universel	5 x 8	4 m
3030024TL	Tubo spirale in poliuretano 8 m con rubinetto rapido universale Polyurethane spiral hose 8 m with universal rapid tap Tuyau spiral en polyuréthane 8 m avec robinet rapide universel	5 x 8	8 m
3030024TM	Tubo spirale in poliuretano 12 m con rubinetto rapido universale Polyurethane spiral hose 12 m with universal rapid tap Tuyau spiral en polyuréthane 12 m avec robinet rapide universel	5 x 8	12 m

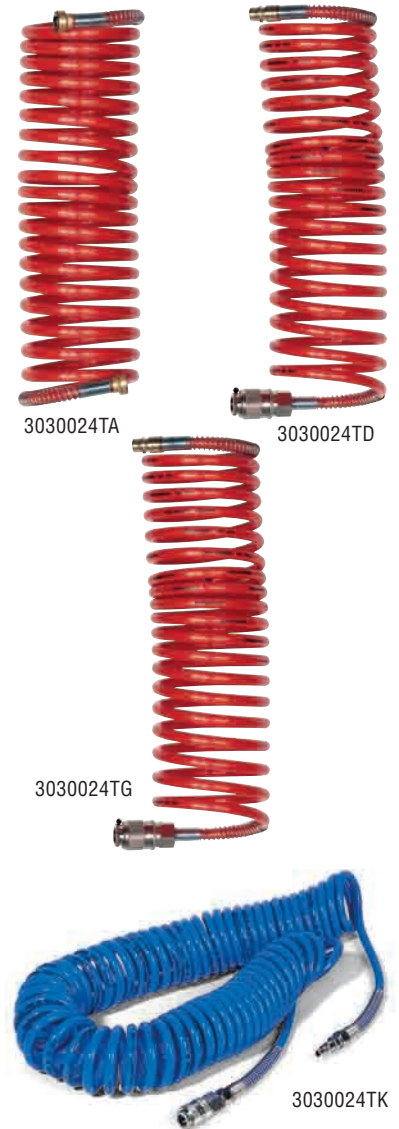

Nota: specificare tipo di rubinetto rapido a sfera a scelta tra CH, I, USA, D.  
 Note: specify type of universal rapid ball tap to be chosen among model CH, I, USA, D.  
 Note: indiquez le type de robinet rapide universel à bille à choisir entre les modèles CH, I, USA, D.

**Avvolgitori tubi aria**  
**Air hoses winders**  
**Enrouleurs tuyaux air**



<b>Codice</b> Code Code	<b>Descrizione</b> Description Description		<b>Conduttori</b> Conductors Conducteurs	<b>Sezione</b> Section Section	<b>Lunghezza</b> Length Longueur	<b>Peso</b> Weight Poids
3030024TP	Avvolgitore compatto autorientante tubo aria 12m Compact automatic air hose winder 12m Enrouleur compact automatique de tuyau air 12m	-	Ø 8 mm	12 m	4,4 kg	1 / 4"
3030024TQ	Avvolgitore autorientante tubo aria 15m Automatic air hose winder 15m Enrouleur automatique de tuyau air 15m	-	Ø 8 mm	15 m	6,5 kg	1 / 4"
3030024TR	Avvolgitore autorientante tubo aria 20m Automatic air hose winder 20m Enrouleur automatique de tuyau air 20m	-	Ø 10 mm	20 m	7,3 kg	3 / 8"

**Gonfiatori portatili / Portable inflators**  
**Gonfleurs portables**

<b>Codice</b> Code Code	<b>Descrizione</b> Description Description
<b>3030024UA</b>	Gonfiagomme manuale lt 10 Manual tyre inflator lt 10 Gonfleur pneus manuel lt 10
<b>3030024UD</b>	Gonfiagomme automatico lt 15 Automatic tyre inflator lt 15 Gonfleur pneus automatique lt 15
<b>3030024UG</b>	Supporto murale per riempimento automatico per 3120004UD Wall holder for automatic filling in for 3120004UD Support mural pour remplissage automatique pour 3120004UD
<b>3030024UK</b>	Supporto mobile per riempimento automatico per 3120004UD Mobile holder for automatic filling in for 3120004UD Support mobile pour remplissage automatique pour 3120004UD



3030024UA



3030024UD

**PISTOLE PER SOFFIAGGIO ARIA**  
**AIR BLOWING GUNS**  
**PISTOLETS POUR SOUFFLAGE AIR**



3030024VA



3030024VD



**Pistole per soffiaggio aria**  
**Air blowing guns**  
**Pistolets pour soufflage air**

<b>Codice</b> Code Code	<b>Descrizione</b> Description Description
<b>3030024VA</b>	Pistola professionale per soffiaggio con regolazione aria tamite leva: passaggio aria a 6 bar (270l/min) - lunghezza 150 mm - specificare tipo di attacco Professional blowing gun provided with lever for the adjustment of the air flow: air flow at 6 bars (270l/min) - 150mm length - specify the kind of coupling Pistolet professionnel pour soufflage avec réglage de l'air par levier: flux d'air à 6 bar (270l/min) - longueur 150 mm - spécifier le type de connexion
<b>3030024VD</b>	Accessori per pistola per soffiaggio: disco, silenziatore, prolunga, ugello Venturi Accessories for blowing gun: disk, silencer, extension, Venturi nozzle Accessoires pour pistolet pour soufflage: disque, silencieux, rallonge, buse Venturi

# LAMPADE ED AVVOLGITORI CAVI ELETTRICI

## LAMPS AND ELECTRIC CABLES WINDERS

### LAMPES ET ENROULEURS DE CÂBLES ÉLECTRIQUES

#### Avvolgitori cavi elettrici

##### Electric cables winders

##### Enrouleurs de câbles électriques

3030024WA



Codice Code Code	Descrizione Description Description	Conduttori Conductors Conducteurs	Sezione Section Section	Lunghezza Length Longueur	Peso Weight Poids
3030024WA	Avvolgitore autorientante cavo corrente 15mt - 230V Automatic electric cable winder 15mt - 230V Enrouleur automatique de câble électrique 15mt - 230V	3	1,5 mm <sup>2</sup>	15 mt	5,7 kg
3030024WD	Avvolgitore cavo autorientante 15mt con lampada neon 11W 230V (output 24V). Con trasformatore 24V. Automatic cable winder 15mt with neon lamp 11W 230V (output 24V). With transformer 24V Enrouleur automatique de câble 15mt avec lampe néon 11W 230V. Avec transformateur 24V	-	2x1 mm <sup>2</sup>	15 mt	4,4 kg

#### Lampade - Lamps - Lampes

Codice Code Code	Descrizione Description Description	Lunghezza Length Longueur	Peso Weight Poids
3030024XA	Lampada 11W con cavo 5m (600 LUX) - 230v Lamp 11 W with 5m cable (600 LUX) - 230v Lampe 11W avec câble 5m (600 LUX) - 230v	5 mt	0,72 kg
3030024XD	Lampada a Led senza fili, ricaricabile, impermeabile, 1200 LUX, autonomia 4 ore Led wireless lamp, rechargeable, water proof, 1200 LUX, 4 hours autonomy Lampe à led sans fils, rechargeable, étanche, 1200 LUX, autonomie 4 heures	-	0,35 kg
3030024XG	Lampada a Led senza fili, ricaricabile, impermeabile, 1700 LUX, autonomia 4 ore Led wireless lamp, rechargeable, water proof, 1700 LUX, 4 hours autonomy Lampe à led sans fils, rechargeable, étanche, 1700 LUX, autonomie 4 heures	-	0,42 kg
3030024XJ	Lampada a Led senza fili, ricaricabile, impermeabile, 2000 LUX, autonomia 3,5 ore Led wireless lamp, rechargeable, water proof, 2000 LUX, 3,5 hours autonomy Lampe à led sans fils, rechargeable, étanche, 2000 LUX, autonomie 3,5 heures	-	0,48 kg
3030024XM	Lampada a 120 LED per lavori sotto il cofano, ricaricabile, impermeabile, autonomia 3 ore 120 LED lamp for works under the hood, rechargeable, water proof, 3 hours autonomy Lampe à 120 LED pour travaux sous le capot, rechargeable, étanche, autonomie 3 heures	-	2,6 kg



3030024XA



3030024XG



3030024XM

#### Lampade led da ispezione estensibili con estremità telescopica

##### Extensible inspection led lights with telescopic end

##### Lampes à led pour inspection extensibles avec bout télescopique

Codice Code Code	Descrizione Description Description
3030024YA	Lampada estensibile tascabile a 1 led bianco ultra-luminoso con estremità telescopica flessibile (angolo 210°) 14,5 - 37 cm, con testa magnetica 2,3kg (batterie incluse). Pocket extensible lamp with 1 white ultra-luminous led with flexible telescopic end (angle 210°) 14,5 - 37 cm, with magnetic head 2,3kg (batteries included). Lampe extensible de poche avec 1 led blanc ultra-lumineux avec bout télescopique flexible (angle 210°) 14,5 - 37 cm, avec tête magnétique 2,3kg (batteries incluses).
3030024YD	Lampada estensibile tascabile a 3 led bianchi ultra-luminosi con estremità telescopica flessibile (angolo 210°) 17 - 55 cm, con testa magnetica 2,3kg (batterie incluse). Pocket extensible lamp with 3 white ultra-luminous leds with flexible telescopic end (angle 210°) 17 - 55 cm, with magnetic head 2,3kg (batteries included). Lampe extensible de poche avec 3 led blancs ultra-lumineux avec bout télescopique flexible (angle 210°) 17 - 55 cm, avec tête magnétique 2,3kg (batteries incluses).
3030024YG	Lampada estensibile tascabile a 3 led bianchi ultra-luminosi con estremità telescopica flessibile (angolo 210°) 17 - 55 cm, con testa magnetica 2,3kg e base magnetica 9kg (batterie incluse). Pocket extensible lamp with 3 white ultra-luminous leds with flexible telescopic end (angle 210°) 17 - 55 cm, with magnetic head 2,3kg and magnetic base 9kg (batteries included). Lampe extensible de poche avec 3 led blancs ultra-lumineux avec bout télescopique flexible (angle 210°) 17 - 55 cm, avec tête magnétique 2,3kg et base magnétique 9kg (batteries incluses).
3030024YJ	Kit ispezione 3-in-1 composto da: lampada codice 3030024YD, 1 specchietto, 1 custodia Inspection kit 3-in-1 consisting of: lamp code 3030024YD, 1 mirror, 1 sheath Kit d'inspection 3-en-1 composé par: lampe code 3030024YD, 1 miroir, 1 étui



3030024YA



3030024YD

3030024YJ

**Pistola chiodatrice**  
**Riveting gun**  
**Pistolet de clouage**

Codice Code Code	Descrizione Description Description
3030025	Pistola chiodatrice mod. OKU AS-9 Riveting gun mod. OKU AS-9 Pistolet de clouage mod. OKU AS-9



3030025

**Accessori e ricambi per chiodatrice**  
**Accessories and spares for riveting gun**  
**Accessoires et pièces de rechange pour pistolet de clouage**



3030027



3030030



3030031

Codice Code Code	Descrizione Description Description
3030027	Punte esterne 00101 / Out. pins 00101 / Pointes ext. 00101
3030028	Punte interne 00102 / Ins. pins 00102 / Pointes int. 00102
3030029	Pistone 00108 / Piston 00108 / Piston 00108
3030030	Caricatore manuale FB 9 / Manual loader FB 9 / Chargeur manuel FB 9
3030031	OR esterno 00103 / Out. OR 00103 / OR ext. 00103
3030032	Punte interne centratrici 00104 Centering ins.pins 00104 / Pointes int. de centrage 00104

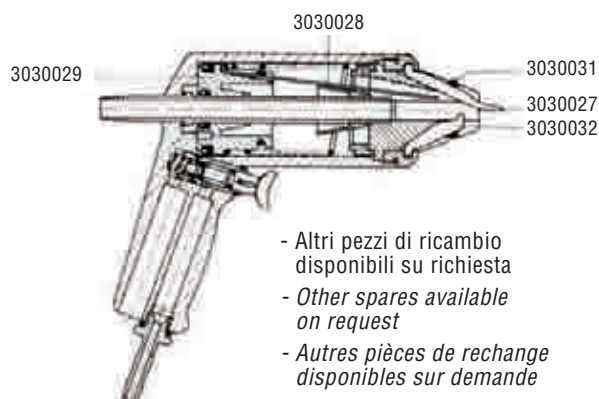

- Altri pezzi di ricambio disponibili su richiesta
- Other spares available on request
- Autres pièces de rechange disponibles sur demande

**Chiodi antighiaccio**  
**Studs**  
**Clous**

Codice Code Code	Misura Sizes Dimension	Pz. / scatola Pcs. / box Pcs. / boîte
3030033A	9/10	1000
3030033B	9/11	1000
3030033C	9/12	1000
3030033D	9/13	1000
3030033E	9/14	1000
3030033F	9/15	1000



- Su richiesta disponibili altre misure e tipologie.
- On request other stud sizes available.
- Autres dimensions de clous disponibles sur demande.



**Leve per pneumatici vettura - Levers for car tyres - Leviers pour pneus tourisme**

<b>Codice</b> <i>Code</i> <i>Code</i>	<b>Descrizione</b> <i>Description</i> <i>Description</i>	<b>Lunghezza pollici</b> <i>Length in inches</i> <i>Longueur en pouces</i>	<b>Lunghezza mm</b> <i>Length in mm</i> <i>Longueur en mm</i>
<b>3030035</b>	Leva originale Moto - Michelin <i>Original Moto lever - Michelin</i> <i>Levier original Moto - Michelin</i>	15	380
<b>3030036</b>	Leva originale Dowidat / <i>Original Dowidat lever / Levier original Dowidat</i>	8	200
<b>3030037</b>	Leva originale Dowidat / <i>Original Dowidat lever / Levier original Dowidat</i>	12	300
<b>3030038</b>	Leva originale Dowidat / <i>Original Dowidat lever / Levier original Dowidat</i>	16	400
<b>3030039</b>	Leva originale Dowidat / <i>Original Dowidat lever / Levier original Dowidat</i>	20	500
<b>3030040</b>	Leva originale Dowidat / <i>Original Dowidat lever / Levier original Dowidat</i>	24	600
<b>3030042</b>	Leva normale / <i>Normal lever / Levier normal</i>	16	400
<b>3030043</b>	Leva normale / <i>Normal lever / Levier normal</i>	20	500
<b>3030043B</b>	Leva normale con estremità a doppia curva <i>Normal lever with double curve end</i> <i>Levier normal avec extrémité à double courbe</i>	20	500
<b>3030044</b>	Leva speciale per Run Flat <i>Special lever for Run Flat</i> <i>Levier spécial pour Run Flat</i>	20	500
<b>3030045</b>	Protezione in plastica per cerchi in lega per leva cod. 3030043 <i>Plastic protection for alloy rims for lever code 3030043</i> <i>Protection en plastique pour jantes en alliage pour levier code 3030043</i>	–	–
<b>3030045A</b>	Protezione in plastica per cerchi in lega <i>Plastic protection for alloy rims</i> <i>Protection en plastique pour jantes en alliage</i>	–	–
<b>3030045D</b>	Protezione in plastica corta <i>Short plastic protection / Protection en plastique courte</i>	–	–
<b>3030048Z</b>	Leva speciale per smontaggio copricerchi <i>Special lever to demount rim covers</i> <i>Levier spécial pour démonter les couvre-jantes</i>	–	–
<b>3030049</b>	Leva speciale per smontaggio copricerchi <i>Special lever to demount rim covers</i> <i>Levier spécial pour démonter les couvre-jantes</i>	13,8	350
<b>3030049A</b>	Leva per raddrizzare cerchi deformati <i>Lever for straightening deformation on rim flange</i> <i>Levier pour redresser les jantes déformées</i>	15,5	390



**Leve per pneumatici autocarro e M.T.**  
**Levers for truck tyres and E.M. / Leviers pour pneus camion et G.C.**

<b>Codice</b> <i>Code</i> <i>Code</i>	<b>Descrizione</b> <i>Description</i> <i>Description</i>	<b>Lunghezza pollici</b> <i>Length in inches</i> <i>Longueur en pouces</i>	<b>Lunghezza mm</b> <i>Length in mm</i> <i>Longueur en mm</i>
<b>3030050</b>	Leva per cerchietti / <i>Lever for small rims / Levier pour petites jantes</i>	26	670
<b>3030051</b>	Leva tipo Savam; ideale per Movimento Terra / <i>Lever similar to Savam; ideal for E.M. Levier similaire à Savam; idéal pour G.C.</i>	36,25	920
<b>3030052</b>	Leva tipo Hyude / <i>Lever similar to Hyude / Levier similaire à Hyude</i>	39	990
<b>3030053</b>	Leva tipo Hyoca / <i>Lever similar to Hyoca / Levier similaire à Hyoca</i>	36,25	920
<b>3030055</b>	Leva Trilex gigante / <i>Large Trilex lever / Levier Trilex grand</i>	55	1400
<b>3030056</b>	Punta di ricambio per leva Trilex <i>Spare pin for Trilex lever / Pointe de rechange pour levier Trilex</i>	-	-
<b>3030057</b>	Punta di ricambio saldata per leva Trilex <i>Spare welded pin for Trilex lever / Pointe de rechange soudée pour levier Trilex</i>	-	-
<b>3030058</b>	Leva per autocarro con uncino <i>Tubeless truck tyre lever with hook / Levier avec le crochet pour jantes tubeless camion</i>	26,57	675
<b>3030062</b>	Leva originale Halte / <i>Original Halte lever / Levier original Halte - Michelin</i>	31,5	800
<b>3030063</b>	Leva tipo Halte / <i>Lever similar to Halte / Levier similaire à Halte</i>	31,5	800
<b>3030064</b>	Leva originale Face / <i>Original Face lever / Levier original Face - Michelin</i>	20,5	520
<b>3030065</b>	Leva tipo Face / <i>Lever similar to Face / Levier similaire à Face</i>	20,5	520
<b>3030068</b>	Leva originale Force / <i>Force original lever / Levier original Force - Michelin</i>	29,5	750
<b>3030069</b>	Leva montaggio autocarro in acciaio cromato <i>Truck mounting lever in chromed steel / Levier pour montage camion en acier chromé</i>	24	610
<b>3030070</b>	Sbloccatalloni tipo Fagus / <i>Beads unlocking tool similar to Fagus Dispositif de déblocage des talons similaire à Fagus</i>	39	1000
<b>3030070A</b>	Attrezzo stallonatore con manico con protezione di plastica <i>Tyre remover tool with plastic protection handle Dispositif détalonneur avec protection en plastique sur la poignée</i>	13	330
<b>3030070B</b>	Attrezzo stallonatore / <i>Tyre remover / Dispositif détalonneur</i>	12	300
<b>3030070C</b>	Leva speciale per ruote Pax / <i>Special lever for Pax tyres / Levier spécial pour pneus Pax</i>	8,7	218
<b>3030070E</b>	Blocco talloni autocarro / <i>Truck tyre bead holder / Coince-talon pour pneus camion</i>	-	-
<b>3030070F</b>	Blocco talloni autocarro in metallo / <i>Metal truck tyre bead holder Coince-talon en métal pour pneus camion</i>	-	-
<b>3030070P</b>	Strumento di montaggio per pneumatici basso profilo <i>Mounting tool for low profile tires / Outil de montage pour pneus à profil bas</i>	-	-



3030071



3030073



3030073P



3030074

**Chiave a croce universale**  
**Universal cross wrench**  
**Clef en forme de croix universelle**

<b>Codice</b> <i>Code</i> <i>Code</i>	<b>Descrizione</b> <i>Description</i> <i>Description</i>	<b>Misure</b> <i>Sizes</i> <i>Dimensions</i>
<b>3030071</b>	Chiave croce vettura <i>Car cross wrench</i> <i>Clef en forme de croix tourisme</i>	17-19-21-22
<b>3030072</b>	Chiave croce autocarro professionale <i>Professional truck cross wrench</i> <i>Clef en forme de croix professionnelle pour camion</i>	24-27-32-3/4"
<b>3030073</b>	Chiave estendibile <i>Extensible wrench</i> <i>Clef extensible</i>	17-19-21-23
<b>3030073P</b>	Chiave a croce ripiegabile vettura <i>Folding car cross wrench</i> <i>Clef pliante en forme de croix tourisme</i>	17-19-21-23
<b>3030074</b>	Kit moltiplicatore di forza 1:56 ideale per allentare / stringere bulloni autocarro. Composto da manovella, estensione bussole 32 e 33 mm <i>Force multiplier kit 1:56 ideal to loosen / tighten truck nuts. Consisting of handle, extension, impact sockets 32 and 33 mm</i> <i>Kit multiplicateur de force 1:56 idéal pour desserrer / serrer les boulons camion. Composé par poignée, rallonge, douilles 32 et 33 mm</i>	32-33

# BUSSOLE E AVVITATORI

IMPACT SOCKETS AND IMPACT WRENCHES  
DOUILLES ET CLEFS DE VISSAGE

italmatic

## Con attacco quadro 1/2" - corte

With square drive 1/2" - short - Avec connexion carrée 1/2" - courtes

Codice Code Code	Misura mm Size in mm Dimension en mm	Ø1	Ø2	Lungh. mm Length in mm Longueur en mm	T
3030080	17	26,5	30	40	10
3030081	18	27,5	30	40	12
3030082	19	29	30	40	12
3030083	20	30	30	40	12
3030084	21	31,5	30	40	14
3030085	22	32,5	30	40	14
3030086	23	34	30	40	14
3030087	24	35	30	45	16
3030088	27	39	30	48	18

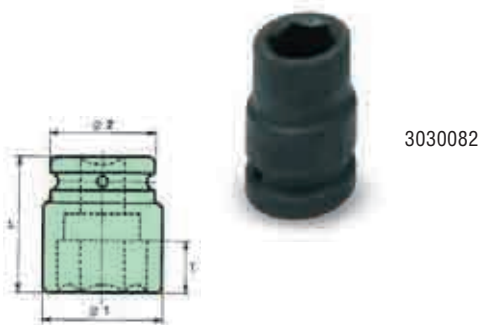

## Con attacco quadro 1/2" - lunghe

With square drive 1/2" - long - Avec connexion carrée 1/2" - longues

Codice Code Code	Misura mm Size in mm Dimension en mm	Ø1	Ø2	Lungh. mm Length in mm Longueur en mm	T
3030091	15	26,5	30	78	10
3030092	17	26,5	30	85	10
3030093	19	29	30	85	12
3030094	21	31,5	30	85	14
3030095	22	32,5	30	85	14
3030096	24	35	30	85	16



## Bussole con attacco quadro 1/2" - lunghe - con rivestimento in plastica

Impact sockets with square drive 1/2" - long - plastic coated  
Douilles avec connexion carrée 1/2" - longues - plastifiées

Codice Code Code	Misura mm Size in mm Dimension en mm	Ø1	Ø2	Lungh. mm Length in mm Longueur en mm	T
3030098A	17	26,5	30	85	10
3030098B	19	29	30	85	12
3030098C	21	31,5	30	85	14



## Bussole con attacco quadro 1/2" - extra lunghe - con rivestimento in plastica

Impact sockets with square drive 1/2" - extra long - plastic coated  
Douilles avec connexion carrée 1/2" - extra longues - plastifiées

Codice Code Code	Misura mm Size in mm Dimension en mm	Ø1	Ø2	Lungh. mm Length in mm Longueur en mm	T
3030099A	17	26,5	30	150	10
3030099B	19	29	30	150	12
3030099C	21	31,5	30	150	14



## Kit di bussole da 1/2" - Kit of impact sockets 1/2" - Jeu de douilles 1/2"

Codice Code Code	Descrizione Description Description
3030098D	Set 3 bussole attacco quadro 1/2" lunghe - Rivestite in plastica Set 3 impact sockets with square drive 1/2" long - Plastic coated Jeu 3 douilles avec connexion carrée 1/2" longues - Plastifiées
3030098E	Set 3 bussole sottili attacco quadro 1/2" Set 3 thin impact sockets with square drive 1/2" / Jeu 3 douilles avec connexion carrée 1/2"
3030098F	Set 3 bussole attacco quadro 1/2" extra lunghe - Rivestite in plastica Set 3 impact sockets with square drive 1/2" extra long - Plastic coated Jeu 3 douilles avec connexion carrée 1/2" extra longues - Plastifiées





# BUSSOLE E AVVITATORI

## IMPACT SOCKETS AND IMPACT WRENCHES DOUILLES ET CLEFS DE VISSAGE

### Con attacco quadro 3/4" - corte

With square drive 3/4" - short - Avec connexion carrée 3/4" - courtes

Codice Code Code	Misura mm Size in mm Dimension en mm	Ø1	Ø2	Lungh. mm Length in mm Longueur en mm	T
3030100	17	31	44	51	10
3030101	19	33,5	44	51	12
3030102	21	36	44	51	14
3030103	22	37	44	51	14
3030104	23	38,5	44	51	14
3030105	24	39,5	44	51	16
3030106	27	43,5	44	54	18
3030107	28	44	44	54	18
3030108	30	47	44	54	20
3030109	32	49,5	44	57	22
3030110	33	51	44	57	22
3030111	36	54,5	44	57	24
3030112	38	57	44	57	24

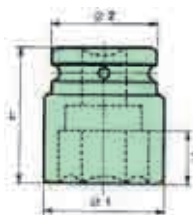

3030100

### Con attacco quadro 3/4" - lunghe

With square drive 3/4" - long - Avec connexion carrée 3/4" - longues

Codice Code Code	Misura mm Size in mm Dimension en mm	Ø1	Ø2	Lungh. mm Length in mm Longueur en mm	T
3030116	22	37	44	100	14
3030117	24	39,5	44	100	16
3030118	27	43,5	44	100	18
3030119	30	47	44	100	20
3030120	32	49,5	44	100	22
3030121	33	51	44	100	22
3030122	36	54,5	44	100	24



3030116

### Con attacco quadro 1" - corte

With square drive 1" - short - Avec connexion carrée 1" - courtes

Codice Code Code	Misura mm Size in mm Dimension en mm	Ø1	Ø2	Lungh. mm Length in mm Longueur en mm	T
3030126	24	42,5	54	60	16
3030127	27	46,5	54	60	18
3030128	30	50	54	62	20
3030129	32	52,5	54	63	22
3030130	33	54	54	63	22
3030131	36	57,5	54	67	24
3030132	38	60	54	67	24

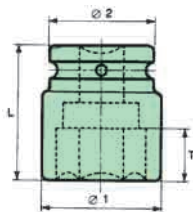

3030126

### Con attacco quadro 1" - lunghe

With square drive 1" - long - Avec connexion carrée 1" - longues

Codice Code Code	Misura mm Size in mm Dimension en mm	Ø1	Ø2	Lungh. mm Length in mm Longueur en mm	T
3030136	24	42,5	54	110	16
3030137	27	46,5	54	110	18
3030138	30	50	54	110	20
3030139	32	52,5	54	110	22
3030140	33	54	54	110	22
3030141	36	57,5	54	110	24
3030142	38	60	54	110	24



3030136

## BUSSOLE E AVVITATORI

IMPACT SOCKETS AND IMPACT WRENCHES  
DOUILLES ET CLEFS DE VISSAGE

italmatic

### Bussole con attacco quadro 1" - lunghe - sottili Impact sockets with square drive 1" - long - thin Douilles avec connexion carrée 1" - longues - minces

Codice Code Code	Misura mm Size in mm Dimension en mm	Ø1	Ø2	Lungh. mm Length in mm Longueur en mm	T
3030143A	27	42,5	51	110	43
3030143B	32	47	51	110	43
3030143C	33	49	51	110	43



3030143B

### Raccordi per bussole Couplings for impact sockets - Raccords pour douilles

Codice Code Code	Descrizione Description Description	Attacco femmina Female drive Connexion femelle	Attacco maschio Male drive Connexion mâle	Lungh. mm Length in mm Longueur en mm
3030145	Riduzione Reduction Réduction	3/4"	1/2"	60
3030146	Riduzione Reduction Réduction	1"	3/4"	74
3030147	Moltiplica Multiplier Multiplicateur	3/4"	1"	65



3030145

### Prolunghe per bussole Extensions for impact sockets - Rallonges pour douilles

Codice Code Code	Descrizione Description Description	Attacco femmina Female drive Connexion femelle	Attacco maschio Male drive Connexion mâle	Lungh. mm Length in mm Longueur en mm
3030150	Prolunga Extension Rallonge	3/4"	3/4"	175
3030151	Prolunga Extension Rallonge	3/4"	3/4"	250



3030150

### Accessori per bussole Accessories for impact sockets - Accessoires pour douilles

Codice Code Code	Descrizione Description Description	Misura mm Size in mm Dimension en mm
3030155	Set 8 bussole rimuovi bulloni Set 8 impact sockets for wheel lug nuts removal Jeu 8 douilles pour enlèvement boulons	17/18,5/20/21,5 23/24,5/26/27,5



3030155

Codice Code Code	Descrizione Description Description
3030160	Attrezzo speciale per montaggio ruote completo di bussole speciali da mm 17/19/21. Consente un perfetto accoppiamento tra cerchio e mozzo ruota (Particolarmente indicato per BMW e Mercedes). Special tool for wheel mounting complete with special impact sockets of mm 17/19/21. It allows a perfect coupling between rim and wheel hub (Suitable in particular for BMW and Mercedes). Outil spécial pour montage roues complet de douilles spéciales mm 17/19/21. Il permet un couplage parfait entre jante et moyeu roue (Particulièrement indiqué pour BMW et Mercedes).



3030160

**BUSSOLE E AVVITATORI**  
**IMPACT SOCKETS AND IMPACT WRENCHES**  
**DOUILLES ET CLEFS DE VISSAGE**



3030161A



3030161B



3030161E



3030161H



3030161L

**Avvitatori reversibili con doppio martello ad espansione**  
**Reversible twin hammer impact wrenches**  
**Clefs de vissage réversibles à double marteau**

Codice Code	Descrizione Description	Coppia max di torsione Max torque Couple de torsion max	Giri al minuto R.P.M. Tours/min.	Peso kg Weight kg Poids kg
3030161A	Avvitatore da 1/2"; dimensione compatta (lungh. 12 cm) e leggero Impact Wrench 1/2"; compact size (12 cm length) and light weight Clef de vissage 1/2"; taille compacte (longueur 12 cm) et légère	678 Nm	10.400	1,5
3030161B	Avvitatore da 1/2" / Impact wrench 1/2" / Clef de vissage 1/2"	610 Nm	7.500	2,6
3030161E	Avvitatore da 3/4" / Impact wrench 3/4" / Clef de vissage 3/4"	1.492 Nm	4.500	4,0
3030161H	Avvitatore da 1" / Impact wrench 1" / Clef de vissage 1"	1.627 Nm	4.500	4,1
3030161L	Avvitatore da 1" professionale - gambo 8" Professional Impact wrench 1" - stem 8" / Clef de vissage professionnelle 1" - Tige 8"	2.983 Nm	3.400	11,8



3030161P



3030161T



3030161T

**Bussole e avvitatori ad alte prestazioni**  
**High performance impact sockets and impact wrenches**  
**Douilles et clefs de vissage à hautes performances**

Codice Code Code	Descrizione Description Description	Coppia max di torsione Max torque Couple de torsion max	Giri al minuto R.P.M. Tours/min.	Peso kg Weight kg Poids kg
3030161P	Avvitatore da 1/2" ad alta prestazione Impact Wrench 1/2" high performance Clef de visage 1/2" high performance	510-680-931Nm	7.930	1,99
3030161T	Set Bussole 1/2"(17-19-21 mm) "slim-power" per cerchi in lega, ad altissima resistenza, lunghezza 85mm. Kit of impact sockets 1/2"(17-19-21 mm) "slim-power" for alloy rims, high resistance, 85mm length Jeu de douilles 1/2"(17-19-21 mm) "slim-power" pour jantes en alliage, à très haute résistance, longueur 85mm	-	-	-

3030162	Set 7 barre di torsione per auto – 1/2 " Set 7 torsion bars for car – 1/2" Jeu 7 barres de torsion pour voiture – 1/2"
---------	--

Misura esagono mm. Hexagon size mm. Dimension hexagone en mm.	Colore Colour Couleur	Nm
17	Verde / Green / Vert	75
17	Rosso / Red / Rouge	110
19	Giallo / Yellow / Jaune	90
19	Blu / Blue / Bleu	110
19	Grigio / Grey / Gris	135
21	Nero / Black / Noir	80
21	Marrone / Brown / Marron	110



3030162

## BUSSOLE E AVVITATORI

### IMPACT SOCKETS AND IMPACT WRENCHES DOUILLES ET CLEFS DE VISSAGE

#### Kit bussole e raccordi con meccanismo di torsione idraulico

#### Kit of impact sockets and connectors with hydraulic torsion mechanism

#### Jeu de douilles et connecteurs avec mécanisme de torsion hydraulique

Codice Code Code	Descrizione Description Description	Misure Sizes Dimensions
3030162H	Kit 3 bussole attacco quadro 1/2" lunghe con meccanismo idraulico di torsione (17-19-21mm) Utilizzare solo con avvitatori da 1/2" con pressione impostata a 90 psi. Forza di torsione 115 Nm <i>Kit of 3 impact sockets with square connection 1/2" long with hydraulic torsion mechanism (17-19-21mm) Use only with 1/2" impact wrenches with pressure set at 90 psi. Torsion force 115 Nm</i> <i>Jeu de 3 douilles avec connexion carrée 1/2" longues avec mécanisme hydraulique de torsion (17-19-21mm) Utiliser seulement avec clefs de vissage à 1/2" avec pression établie à 90 psi. Force de torsion 115 Nm</i>	100
3030162K	Kit 3 raccordi (3/8", 1/2", 3/4") con meccanismo di torsione idraulico. Utilizzare solo con avvitatori da 1/2" con pressione impostata a 90 psi. Torsione max 100 Nm. <i>Kit of 3 connectors (3/8", 1/2", 3/4") with hydraulic torsion mechanism. Use only with 1/2" impact wrenches with pressure set at 90 psi. Torsion max. 100 Nm.</i> <i>Jeu de 3 connecteurs (3/8", 1/2", 3/4") avec mécanisme hydraulique de torsion. Utiliser seulement avec clefs de vissage à 1/2" avec pression établie à 90 psi. Torsion max. 100 Nm.</i>	100



3030163



3030163B

#### Cricchetto reversibile maschio

#### Reversible male ratchet

#### Cliquet réversible mâle

Codice Code Code	Descrizione Description Description	Lunghezza (mm) Length (mm) Longueur (mm)
3030163	Cricchetto reversibile maschio professionale, attacco quadro 1/2" <i>Professional reversible male ratchet, square connection 1/2"</i> <i>Cliquet professionnel réversible mâle, connexion carrée 1/2"</i>	265
3030163B	Cricchetto reversibile maschio economico, attacco quadro 1/2" <i>Cheap reversible male ratchet, square connection 1/2"</i> <i>Cliquet économique réversible mâle, connexion carrée 1/2"</i>	250



3030164B

**Chiavi dinamometriche a scatto**  
**Snap-in dynamometric wrenches**  
**Clefs dynamométriques à détente**

- Serraggi rapidi e precisi, regolazione rapida e semplice grazie ad una levetta snodata retraibile nell'impugnatura.
- L'impugnatura ruota libera per evitare alterazioni accidentali della coppia.
- Doppio segnale al raggiungimento della coppia: segnale acustico e alleggerimento sforzo.
- Ritorno automatico per operazione successiva.
- Quick and precise locking, quick and simple adjustment thanks to an articulated retractable lever in the handle.
- The handle rotates free to avoid accidental changes to the torque.
- Double signal once reached the torque: acoustic signal and stress lightening.
- Automatic return for the following operation.
- Serrage rapides et précis, réglage rapide et simple grâce à un levier articulé rétractile dans la poignée.
- La poignée tourne libre afin d'éviter des altérations accidentelles du couple.
- Signal double quand le couple est atteint: signal acoustique et allègement effort.
- Retour automatique pour l'opération successive.

Codice Code Code	Descrizione Description Description	Nm	Attacco Drive Connexion	mm	Kg
3030164A	Chiave dinamometrica a scatto con molla e senza cricchetto. Ideale per autovettura. <i>Dynamometric snap-in wrench with spring and without ratchet. Ideal for car.</i> <i>Clef dynamométrique à détente avec ressort et sans cliquet. Idéale pour tourisme.</i>	25-150	1/2"	575	1,7
3030164B	Chiave dinamometrica a scatto con molla e senza cricchetto. Ideale per autocarro. <i>Dynamometric snap-in wrench with spring and without ratchet. Ideal for truck.</i> <i>Clef dynamométrique à détente avec ressort et sans cliquet. Idéale pour camion.</i>	140-800	3/4"	935	6,5



3030164C



3030164N

**Chiavi dinamometriche a scatto a geometria variabile**  
**Snap-in dynamometric wrenches with variable geometry**  
**Clefs dynamométriques à détente à géométrie variable**

- Regolazione della coppia mediante la variazione di posizione dei leverismi interni garantendo una maggiore durata della taratura.
- Precisione di serraggio +/-3%.
- Doppio segnale al raggiungimento della coppia: segnale acustico e alleggerimento sforzo.
- Adjustment of the torque through the variation of position of inside leverages assuring a longer duration of calibration.
- Locking precision +/-3%.
- Double signal once reached the torque: acoustic signal and stress lightening.
- Réglage du couple parmi la variation de position des leviers intérieurs en assurant une durée majeure de la calibration.
- Précision de serrage +/-3%.
- Signal double quand le couple est atteint: signal acoustique et allègement effort.

Codice Code Code	Descrizione Description Description	Nm	Attacco Drive Connexion	mm	Kg
3030164C	Chiave dinamometrica a scatto a geometria variabile con cricchetto reversibile. Ideale per autovettura. <i>Dynamometric snap-in wrench with variable geometry with reversible ratchet. Ideal for car.</i> <i>Clef dynamométrique à détente à géométrie variable avec cliquet réversible. Idéale pour tourisme.</i>	40-200	1/2"	450	1,2
3030164D	Chiave dinamometrica a scatto a geometria variabile con cricchetto reversibile. Ideale per autocarro. <i>Dynamometric snap-in wrench with variable geometry with reversible ratchet. Ideal for truck.</i> <i>Clef dynamométrique à détente à géométrie variable avec cliquet réversible. Idéale pour camion</i>	160-800	3/4"	1140	6,7
3030164N	Moltiplicatore di coppia con barra di reazione a staffa. Utile in spazi limitati e poco accessibili. <i>Servo amplifier with bracket torque tube. Useful in limited spaces with difficult access.</i> <i>Multiplicateur de couple avec barre de réaction à bride. Utile pour places limitées et peu accessibles.</i>	500-2700	3/4"-1"	-	6,34

**Valvole tubeless in gomma - Rubber tubeless valves - Valves tubeless en caoutchouc (\*)**

Codice Code Code	Mod. Mod. Mod.	Lungh. mm Length in mm Longueur en mm	Base Base Base	Foro Hole Forure	Max Bar	Applicazione Application Application
3040001	TR 412	33	19,5	11,3	4,5	
3040002	TR 413	43	19,5	11,3	4,5	
3040003	TR 414	49	19,5	11,3	4,5	
3040004	TR 414L	56,50	19,5	11,3	4,5	
3040005	TR 415	43	23,5	15,7	4,5	
3040006	TR 418	61,5	19,5	11,3	4,5	
3040007	TR 423	74	19,5	11,3	4,5	
3040008	TR 425	60,5	23,5	15,7	4,5	



3040002

(\*) disponibili smontate su richiesta / available dissembled on request / disponible démontées sur demande

**Valvole tubeless con stelo cromato - Tubeless valves with chromed sleeve**  
**Valves tubeless avec embout chromé**

Codice Code Code	Mod. Mod. Mod.	Lungh. mm Length in mm Longueur en mm	Base Base Base	Foro Hole Forure	Max Bar	Applicazione Application Application
3040008A	TR 412	33	19,5	11,3	4,5	
3040009	TR 413	42,5	19,5	11,3	4,5	
3040010	TR 414	49	19,5	11,3	4,5	
3040011	TR 418	61,5	19,5	11,3	4,5	



3040009



3040010

**Valvole tubeless Snap-in interamente cromate - Snap-in tubeless valves completely chromed - Valves tubeless Snap-in complètement chromées**

Codice Code Code	Mod. Mod. Mod.	Lungh. mm Length in mm Longueur en mm	Base Base Base	Foro Hole Forure	Max Bar	Applicazione Application Application
3040011D	TR 412	33	19,5	11,3	4,5	
3040011E	TR 413	42,5	19,5	11,3	4,5	
3040011F	TR 414	49	19,5	11,3	4,5	
3040011L	TR 418	61,5	19,5	11,3	4,5	



3040011D



3040011F



3040011L

**INFORMAZIONI SUL MONTAGGIO DELLE VALVOLE PER PNEUMATICI**

**Il cerchio**

- Il foro per la valvola deve essere rotondo e non deve essere ovale. Diametro 11,3-0/+0,4 mm;
- Il foro del cerchio deve essere esente da bave e danni e deve essere conforme alle normative ETRTO; Spessore del cerchio min. 1,8 mm / max 4 mm.
- Curvatura max 25° - utilizzare il copricerchio esistente per evitare una curvatura eccessiva.
- Altrimenti installare una valvola di metallo;
- Non dimenticare il cappelletto valvola che protegge da sporco e corrosione.

**Condizioni di funzionamento**

- La velocità max raccomandata quando si utilizzano le valvole a scatto è di 210 km/h. Per velocità più alte utilizzare valvole di metallo;
- Pressione di funzionamento max per valvole a scatto (a temperatura ambiente): 4,5 bar. Attenzione: gli aumenti di pressione aria aumentano la temperatura del pneumatico!
- Ad una pressione di funzionamento superiore a 7 bar utilizzare valvole di metallo in grado di funzionare fino a 14 bar;
- In ogni caso fare sempre riferimento alle indicazioni fornite dal produttore.

**Montaggio**

- Utilizzare un utensile montaggio valvole adeguato (utensile di estrazione);
- Durante la procedura di montaggio non tirate le valvole a scatto per più di 10 mm, per evitare danni;
- L'estrazione della valvola deve avvenire assialmente al foro valvola - non inclinare!
- Per un montaggio sicuro e semplice delle valvole a scatto utilizzare pasta per montaggio.

**INFORMATION ON THE ASSEMBLING OF VALVES FOR TYRES**

**Rim**

- The hole for the valve has to be round and not oval. Diameter 11,3 -0/+0,4 mm;
- The rim hole has to be without burrs and damages and it has to comply with ETRTO rules; Rim thickness min. 1,8 mm / max. 4 mm.
- Max. bending 25° - use the existing rim cover to avoid an excessive bending. Otherwise install a metal valve;
- Do not forget the valve cap - it protects from dirt and corrosion.

**Working conditions**

- The max. recommended speed when snap-in valves are employed is 210 km/h. For higher speeds use metal valves.
- Max. working pressure for snap-in valves (at environmental temperature): 4.5 bar. Caution: air pressure increases rise the tyre temperature!
- At a working pressure higher than 7 bar - please use metal valves capable to work up to 14 bar.
- In any case, always make reference to the indications given by the manufacturer.

**Assembling**

- Use a suitable tool to mount valves (withdrawal tool).
- During the assembling procedure do not pull the snap-in valves by more than 10 mm, to avoid damages.
- The valve withdrawal has to occur axially to the valve hole - do not bend!
- For a safe and simple assembling of snap-in valves, use mounting paste.

**Jante**

- Le trou pour la valve doit être rond et non pas ovale. Diamètre 11,3 -0/+0,4 mm.
- Le trou de la jante ne doit pas avoir de bavures et endommagements et il doit être conforme aux normes ETRTO. Épaisseur de la jante min. 1,8 mm / 4 mm max.
- Courbement max. 25° - utiliser le couvercle de la jante existant afin d'éviter un courbement excessif. Autrement, installer une valve en métal.
- N'oubliez pas le bouchon de la valve - il protège de saleté et corrosion.

**Conditions de fonctionnement**

- La vitesse max. recommandée quand on utilise des valves snap-in est 210 km/h. Pour des vitesses majeures, veuillez utiliser des valves en métal.
- Pression de fonctionnement max. pour valves snap-in (à température ambiante): 4.5 bar. Attention: les augmentations de pression air font monter la température du pneu!
- À une pression de fonctionnement supérieure à 7 bar - svp utilisez des valves en métal en mesure de fonctionner jusqu'à 14 bar.
- En tous cas, faire toujours référence aux indications données par le fabricant.

**Montage**

- Utiliser un outil de montage valves indiqué (outil à extraction).
- Pendant le montage ne tirez pas les valves snap-in pour plus de 10 mm, afin d'éviter endommagements.
- L'extraction de la valve doit se vérifier axialement au trou de la valve - ne pas incliner!
- Pour un montage sûr et simple de la valve snap-in utiliser de la pâte pour le montage.

**Legenda**



Moto



Auto  
Car - Voiture



Furgone  
Light truck - Camionnette



Autocarro  
Truck - P.L.



Trattore  
Tractor - Tracteur



EM-OTR



**Valvole tubeless high performance per vettura**  
**High performance tubeless valves for car**  
**Valves tubeless high performance pour voiture**

Codice Code Code	Descrizione Description Description	Rif. Ref. Réf.	Lungh. mm Length in mm Longueur en mm	Max Bar	Torque Nm	Foro Hole Forure	Applicazione Application Application
3040011N	Valvola tubeless nichelata / Nickel-plated tubeless valve Valve tubeless nickelée	-	26	14	3:5	8,3	
3040011P	Valvola tubeless nichelata / Nickel-plated tubeless valve Valve tubeless nickelée	-	39	14	3:5	8,3	
3040011S	Valvola tubeless nichelata / Nickel-plated tubeless valve Valve tubeless nickelée	-	39	14	3:5	8,3	
3040012	Valvola tubeless nichelata / Nickel-plated tubeless valve Valve tubeless nickelée	V2-04-1	35	14	9:14	11,3	
3040013	Valvola in ottone / Brass valve / Valve cuivrée	V2-04-1	35	14	9:14	11,3	
3040013B	Valvola in ottone / Brass valve / Valve cuivrée	V2-04-1	35	14	9:14	11,3	
3040014	Valvola tubeless nichelata / Nickel-plated tubeless valve Valve tubeless nickelée	V2-05-1	39	14	3:5	11,3	
3040014A	Valvola tubeless nichelata con dado lungo e guarnizione in nylon Nickel-plated tubeless valve with long nut and nylon seal Valve tubeless nickelée avec écrou long et joint en nylon	-	42	14	3:5	11,3	
3040014B	Valvola tubeless nichelata con dado lungo Nickel-plated tubeless valve with long nut Valve tubeless nickelée avec écrou long	-	42	14	3:5	11,3	
3040014C	Valvola tubeless nichelata con dado corto Nickel-plated tubeless valve with short nut Valve tubeless nickelée avec écrou court	-	42	14	3:5	11,3	
3040014E	Valvola tubeless nichelata con dado corto Nickel-plated tubeless valve with short nut Valve tubeless nickelée avec écrou court	-	37	14	3:5	11,3	
3040014W	Valvola tubeless nichelata con base piatta Nickel-plated tubeless valve with flat base Valve tubeless nickelée avec base plate	-	37	14	3:5	11,3	
3040014Z	Valvola tubeless in alluminio / Alu tubeless valve Valve tubeless en aluminium	-	42	14	3:5	11,3	
3040015	Valvola tubeless nichelata / Nickel-plated tubeless valve Valve tubeless nickelée	-	42	14	3:5	11,3	
3040015A	Valvola tubeless in alluminio / Alu tubeless valve Valve tubeless en aluminium	-	36	14	3:5	11,3	
3040015B	Valvola tubeless in alluminio nera / Black alu tubeless valve Valve tubeless en aluminium noire	-	42	14	3:5	11,3	
3040015D	Valvola tubeless in alluminio / Alu tubeless valve Valve tubeless en aluminium	-	36	14	3:5	11,3	
3040018	Valvola tubeless nichelata / Nickel-plated tubeless valve Valve tubeless nickelée	V2-05-02	39,5	14	3:5	15,7	
3040018C	Valvola tubeless nichelata / Nickel-plated tubeless valve Valve tubeless nickelée	-	36,5	14	3:5	11,3/15,7	



**VALVOLE ED ACCESSORI**  
**VALVES AND ACCESSORIES**  
**VALVES ET ACCESSOIRES**



3040017



3040017A



3040017B



3040017H/L/M



3040017P/Q/R

**Valvole tubeless ad alta pressione per veicoli commerciali**  
**High pressure tubeless valves for commercial vehicles**  
**Valves tubeless haute pression pour véhicules commerciaux**

<b>Codice</b> Code Code	<b>Descrizione</b> Description Description	<b>Rif.</b> Ref. Réf.	<b>Lungh. mm</b> Length in mm Longueur en mm	<b>Max Bar</b>	<b>Torque</b> Nm	<b>Foro</b> Hole Forure	<b>Applicazione</b> Application Application
3040017	Valvola tubeless Snap-in Snap-in tubeless valve / Valve tubeless Snap-in	TR 600 HP	44	5,5	-	11,3	
3040017A	Valvola tubeless Snap-in lunga Long Snap-in tubeless valve Valve tubeless Snap-in longue	TR 602 HP	63	5,5	-	11,3	
3040017B	Valvola tubeless Snap-in alta pressione High pressure Snap-in tubeless valve Valve tubeless Snap-in haute pression	TR 600 XHP	43,5	5,5	-	11,3	
3040017C	Valvola tubeless Snap-in alta pressione lunga High pressure long Snap-in tubeless valve Valve tubeless Snap-in longue haute pression	TR 602 XHP	62,1	5,5	-	11,3	
3040017E	Valvola tubeless Snap-in Snap-in tubeless valve / Valve tubeless Snap-in	TR 801 HP	48	5,5	-	15,7	
3040017F	Valvola tubeless Snap-in lunga Long Snap-in tubeless valve Valve tubeless Snap-in longue	TR 802 HP	66	5,5	-	15,7	
3040017H	Valvola tubeless Snap-in a smontaggio facile CVV Snap-in tubeless valve easy disassembling CVV Valve tubeless Snap-in démontage facile CVV	-	40	7,0	-	11,3	
3040017L	Valvola tubeless Snap-in a smontaggio facile CVV Snap-in tubeless valve easy disassembling CVV Valve tubeless Snap-in démontage facile CVV	-	47	7,0	-	11,3	
3040017M	Valvola tubeless Snap-in a smontaggio facile CVV Snap-in tubeless valve easy disassembling CVV Valve tubeless Snap-in démontage facile CVV	-	60	7,0	-	11,3	
3040017N	Valvola tubeless metallo per alte temperature e pressioni ASC-HT Tubeless metal valve for high temperatures and pressures ASC-HT Valve tubeless métal pour hautes températures et pressions ASC-HT	-	31	14,0	4:6	11,3	
3040017P	Valvola tubeless metallo per alte temperature e pressioni ASC-HT Tubeless metal valve for high temperatures and pressures ASC-HT Valve tubeless métal pour hautes températures et pressions ASC-HT	-	40	14,0	4:6	11,3	
3040017Q	Valvola tubeless metallo per alte temperature e pressioni ASC-HT Tubeless metal valve for high temperatures and pressures ASC-HT Valve tubeless métal pour hautes températures et pressions ASC-HT	-	47	14,0	4:6	11,3	
3040017R	Valvola tubeless metallo per alte temperature e pressioni ASC-HT Tubeless metal valve for high temperatures and pressures ASC-HT Valve tubeless métal pour hautes températures et pressions ASC-HT	-	60	14,0	4:6	11,3	

**TR 600XHP**



Applicazione: per furgoni, roulotte / campers, fuoristrada, camionette.

Caratteristiche rispetto alle valvole Snap-in comuni:

- Gamma di pressione estesa (fino a 5,5 bar) che aumenta la sicurezza;
- Gambo in metallo più lungo che si estende nel foro del cerchio, garantendo una maggior stabilità durante la guida e prevenendo un'espansione eccessiva durante la procedura di montaggio;
- Possibilità di utilizzo con prolunga;
- Facile installazione con l'ausilio di acqua. Non usare pasta per montaggio pneumatici;
- Facile procedura di smontaggio, semplicemente spingendo la valvola attraverso il foro del cerchio.

Application: for vans, motor homes, off-road vehicles, light truck.

Key features compared to common Snap-in valves:

- Extended pressure range (up to 5,5 bar) increases security;
- Longer metal stem, extended into the rim hole, provides more stability during driving and prevents excess of expansion during the mounting process;
- Possible usage with valve extension
- Simple installation with the aid of water. Do not use tyre mounting paste;
- Simple dismounting process, just pushing the valve through the rim hole.

Application: pour fourgons, roulotte / campers, tout-terrain, camionnettes.

Caractéristiques comparé aux valves Snap-in communes:

- Gamme de pression étendue (jusqu'à 5,5 bar) qui augmente la sécurité;
- Tige en métal plus longue, étendue dans le trou de la jante, qui garantie plus de stabilité pendant la conduite et prévient une expansion excessive pendant le montage;
- Utilisation possible avec rallonge valve;
- Installation simple à l'aide d'eau. Ne pas utiliser pâte de montage pneus;
- Démontage simple, pousser la valve à travers le trou de la jante.

**CVV**



Applicazione: per furgoni, roulotte / campers, fuoristrada, camionette.

Caratteristiche chiave rispetto alle valvole Snap-in comuni:

- Pressione fino a 7 bar;
- Cappelletto valvola con tenuta di qualità superiore;
- Il cappelletto valvola non necessita di essere rimosso durante il montaggio;
- Bordo di tenuta ottimale;
- Labbro di tenuta altamente flessibile: utilizzare pasta montaggio pneumatici durante il montaggio della valvola;
- Rondella a spinta brevettata con punto di rottura predeterminato per una facile rimozione (nessun danno ai cerchi): rompere semplicemente l'anello in plastica con le pinze o con un cacciavite per toglierla.

Application: for vans, motor homes, off-road vehicles, light truck.

Key features compared to common Snap-in valves:

- Pressure up to 7 bar;
- Top Quality sealed valve cap;
- Valve cap doesn't need to be removed during assembly;
- Optimal sealing contour;
- Highly flexible sealing lip: use tyre mounting paste while mounting the valve;
- Patented thrust washer with predetermined breaking point for easy removal (no damage to rims): just break the plastic ring with pliers or a screwdriver to remove.

Application: pour fourgons, roulotte / campers, tout-terrain, camionnettes.

Caractéristiques dominantes comparé aux valves Snap-in communes:

- Pression jusqu'à 7 bar;
- Bouchon valve à étanche de qualité supérieure;
- Le bouchon valve ne nécessite pas d'être enlevé pendant le montage;
- Contour d'étanche optimal;
- Lèvre d'étanche très flexible: utiliser pâte montage pneus pendant le montage de la valve;
- Rondelle de butée brevetée avec point de rupture prédéterminé pour enlèvement facile (pas de dommages aux jantes): rompre tout simplement l'anneau en plastique par des pinces ou par un tournevis pour l'enlèvement.

**ASC-HT**



Applicazione: per furgoni, roulotte / campers, fuoristrada, camionette.

Caratteristiche chiave rispetto alle valvole Snap-in comuni:

- Pressione fino a 14 bar;
- Tenuta ad alte temperature (max. fino a 150°C);
- Concetto di tenuta completamente nuovo che assicura una pressione costante per la durata della valvola;
- Il cappelletto valvola non necessita di essere rimosso durante il montaggio;
- Il disco di plastica protegge i cerchi in lega;
- La base valvola arrotondata previene danni al pneumatico.

Application: for vans, motor homes, off-road vehicles, light truck.

Key features compared to common snap-in valves:

- Pressure up to 14 bar;
- High temperature-sealing (max up to 150°C);
- Completely new sealing concept which ensures constant pressure tightness during the valve lifecycle;
- Valve cap doesn't need to be removed during assembly;
- Captive plastic disc protects alloy rims;
- Rounded valve base to prevent tyre damages.

Application: pour fourgons, roulotte / campers, tout-terrain, camionnettes.

Caractéristiques dominantes comparé aux valves Snap-in communes:

- Pression jusqu'à 14 bar;
- Étanche hautes températures (max. jusqu'à 150°C);
- Concept d'étanche complètement neuf qui assure une pression constante pendant la durée de la valve;
- Le bouchon valve ne nécessite pas d'être enlevé pendant le montage;
- Le disque en plastique protège les jantes en alliage;
- Base valve arrondie pour prévenir dommages au pneu.

**Valvole per moto, scooter, cicli**  
**Valves for motorcycle, scooter, bicycle**  
**Valves pour motocyclette, scooter, vélo**

Codice Code Code	Descrizione Description Description	Rif. Ref. Réf.	Lungh. mm Length in mm Longueur en mm	Max Bar	Torque Nm	Foro Hole Forure	Applicazione Application Application
3040019	Valvola tubeless in gomma Rubber tubeless valve Valve tubeless en caoutchouc	TR438	40,5	4,5	-	8,8	
3040020	Valvola diritta in metallo per camera d'aria Straight metal valve for air tube Valve droite en métal pour chambre à air	-	35	-	7:10	9	
3040021	Valvola tubeless diritta Straight tubeless valve Valve tubeless droite	V1-10-01	35	4,5	7:10	8,3	
3040021A	Valvola tubeless diritta in alluminio Straight tubeless alu valve Valve tubeless droite en aluminium	V1-10-01	35	4,5	3:5	8,3	
3040021B	Valvola tubeless diritta in alluminio nera Straight tubeless alu valve black Valve tubeless droite en aluminium noir	-	35	4,5	3:5	8,3	



Codice Code Code	Descrizione Description Description	Rif. Ref. Réf.	Lungh. mm Length in mm Longueur en mm	Max Bar	Torque Nm	Foro Hole Forure	Applicazione Application Application
3040022	Valvola tubeless 80° in alluminio 80° aluminium valve Valve en aluminium à 80°	-	25	-	3:5	8,3	
3040022A	Valvola tubeless 80° in alluminio 80° tubeless aluminium valve Valve tubeless en aluminium à 80°	-	25	-	3:5	11,3	
3040022C	Valvola tubeless in ottone nichelato Nickel-plated brass tubeless valve Valve tubeless en laiton nickelé	TR 430A	37	-	3:5	8,3	
3040022D	Valvola tubeless in ottone nichelato Nickel-plated brass tubeless valve Valve tubeless en laiton nickelé	TR 435	37	-	7:10	11,3	
3040022E	Valvola tubeless 80° in alluminio nera 80° tubeless aluminium valve black Valve tubeless en aluminium à 80° noir	-	25	-	3:5	11,3	
3040022F	Valvola tubeless 80° in alluminio nera 80° tubeless aluminium valve black Valve tubeless en aluminium à 80° noir	-	25	-	3:5	8,3	
3040023	Valvola tubeless scooter a 90° 90° tubeless scooter valve Valve tubeless pour scooter à 90°	-	30	-	-	11,3	
3040023C	Valvola tubeless scooter a 90° 90° tubeless scooter valve Valve tubeless pour scooter à 90°	-	30	-	-	8,3	



**Valvole invisibili / Invisible valves / Valves invisibles**

Codice Code Code	Descrizione Description Description	Note Notes Notes	Applicazione Application Application
3040028	Kit valvole invisibili foro 8,3 mm Kit of invisible valves hole 8,3 mm Jeu de valves invisibles forure 8,3 mm	Contiene 4 valvole invisibili It contains 4 invisible valves Il contient 4 valves invisibles	
3040028A	Kit valvole invisibili foro 11,3 mm Kit of invisible valves hole 11,3 mm Jeu de valves invisibles forure 11,3 mm	Contiene 4 valvole invisibili It contains 4 invisible valves Il contient 4 valves invisibles	



**Introduzione ai Sistemi TPMS per controllo pressione pneumatici**  
**Introduction to TPMS systems for tyre pressure monitoring**  
**Introduction aux systèmes TPMS pour contrôle pression pneus**

Guasti e difetti degli pneumatici sono le cause principali di incidenti: una pressione troppo bassa degli pneumatici comporta un'eccessiva flessione e l'usura anticipata. Alle alte velocità la conseguenza può anche essere uno scoppio del pneumatico.

I sistemi per il controllo della pressione pneumatici (TPMS) avvisano in caso di perdita di pressione improvvisa o graduale.

Inoltre i TPMS consentono di aumentare significativamente la durata degli pneumatici, fino a raddoppiarla, e di ridurre fino al 5% il consumo del carburante.

Anche nel settore dei veicoli commerciali i sistemi per il controllo della pressione pneumatici sono molto importanti riducendo considerevolmente i costi di esercizio di un camion.

Negli Stati Uniti, i sistemi TPMS sono ormai da tempo resi obbligatori su tutte le vetture di nuova immatricolazione (e quindi predisposte dal O.E. con valvole a controllo di pressione) e su tutte le vetture già in circolazione (con sistemi TPMS after market).

A seguito del regolamento Europeo N° 661/2009, i sistemi di controllo pressione pneumatici (TPMS) saranno obbligatori per tutti i nuovi modelli di veicoli omologati a partire dal 1 Novembre 2012 e per tutti i veicoli prodotti a partire dal 1 Novembre 2014.

Il TPMS è un sistema di sicurezza analogamente all'air bag o all'ABS. Questo sistema deve essere sottoposto a manutenzione periodica per garantirne il perfetto funzionamento.

Per garantire il servizio, l'officina deve disporre di un pacchetto TPMS minimo (sensori correnti, kit di servizio, strumenti specifici, strumenti elettronici di riprogrammazione)

*Breakages and faults of tyres are the main causes of accident: a too low pressure of tyres involves an excessive flexure and an anticipated wear. At high speeds the consequence can even be a tyre explosion.*

*Systems for tyre pressure control (TPMS) warn in case of sudden or gradual loss of pressure.*

*Moreover TPMS allow to increase significantly the life of tyres, up to doubling it, and to reduce fuel consumption up to 5%.*

*Also in the field of commercial vehicles the systems for tyre pressure control are very important reducing considerably the running costs of a truck.*

*In the U.S.A., TPMS systems are obligatory by now since long time on all cars of new registration (therefore equipped by O.E. with pressure control valves) and on all cars already circulating (with TPMS after market systems).*

*According to EEC regulation N° 661/2009, Tyre Pressure Monitoring Systems (TPMS) will be mandatory on all vehicles homologated in Europe after 1st November 2012 and all vehicles manufactured after 1st November 2014.*

*TPMS is a safety system like Air Bags or ABS. This system must be periodically serviced to insure its reliability.*

*To be able to service TPMS, a workshop must have a minimum package (most popular sensors, service kits, specific tools, electronic reprogramming tools).*

*Pannes et défauts des pneus sont les causes principales d'incidents: une pression trop basse des pneus entraîne une flexion excessive et l'usure anticipée. Aux vitesses hautes la conséquence peut même être l'explosion du pneu. Les systèmes pour le contrôle de la pression des pneus (TPMS) avertissent en cas de perte de pression soudaine ou graduelle.*

*En outre les TPMS permettent d'augmenter de manière significative la durée des pneus, jusqu'à la doubler, et de réduire la consommation du carburant jusqu'à 5%.*

*Même dans le secteur des véhicules commerciaux les systèmes de contrôle de la pression des pneus sont très importants en réduisant considérablement les coûts de gestion d'un camion.*

*Aux Etats-Unis, les systèmes TPMS sont désormais depuis longtemps obligatoires sur toutes voitures de nouvelle immatriculation (et donc équipées par O.E. de valves à contrôle de pression) et sur toutes voitures déjà en circulation (avec systèmes TPMS after market).*

*Selon le règlement Européen N° 661/2009, les systèmes de contrôle pression pneus (TPMS) seront obligatoires pour tous nouveaux modèles de véhicules homologués à partir du 1er novembre 2012 et pour tous véhicules produits à partir du 1er novembre 2014.*

*Le TPMS est un système de sécurité analogue à l'air bag ou à l'ABS. Ce système doit être soumis à entretien périodique pour en assurer le fonctionnement parfait.*

*Afin de garantir le service, l'atelier doit disposer d'un paquet TPMS minimum (senseurs courant, jeu de service, instruments spécifiques, instruments électroniques de ré-programmation)*

**Manutenzione valvole TPMS**  
**TPMS maintenance systems**  
**Entretien valves TPMS**

- 1) ad ogni cambio di pneumatico, sostituire sempre gli accessori sistematicamente (interno, cappelletto, dado, rondella metallo, guarnizione)
- 2) assicurarsi di rispettare la coppia dell'interno valvola
- 3) assicurarsi di rispettare la coppia del dado
- 4) usare solo interni valvola nichelati (non interni valvola gialli in ottone grezzo)
- 5) usare solo cappelletti in plastica od in alluminio

- 1) at each tyre change, always replace the accessories systematically (core, cap, nut, metal washer, seal/joint);
- 2) ensure to respect the core torque
- 3) ensure to respect the nut torque
- 4) only use nickel plated core (no yellow raw brass core)
- 5) only use plastic caps or aluminium caps

- 1) à chaque change de pneu, remplacer toujours les accessoires systématiquement (mécanisme, bouchon, écrou, rondelle métal, joint)
- 2) s'assurer de respecter le couple du mécanisme
- 3) s'assurer de respecter le couple de l'écrou
- 4) utiliser seulement mécanismes nickelés (non pas mécanismes jaunes en laiton brut)
- 5) utiliser seulement bouchons en plastique ou en aluminium



Non usare mai cappelletti in ottone o ottone nichelato, che potrebbero creare corrosione.

Utilizzare solo cappelletti in plastica o alluminio.

*Never use any raw brass or nickel plated brass cap which can create some corrosion.*

*Use only plastic or aluminium cap.*

*Pour éviter la corrosion, ne jamais utiliser un bouchon en laiton brut ou en laiton nickelé.*

*Utiliser seulement un bouchon en aluminium ou en plastique.*

Utilizzare unicamente interni valvola nichelati. Rispettare le indicazioni per la coppia di serraggio (0,25Nm).

*Only use nickel plated valve core and conform to core torque (0,25Nm).*

*Utiliser uniquement un mécanisme en laiton nickelé. Respecter le couple de serrage recommandé (0,25Nm).*

**VALVOLE ED ACCESSORI**  
**VALVES AND ACCESSORIES**  
**VALVES ET ACCESSOIRES**



3040029



3040029M



3040029D

3040029M



3040029Z



3040029W

**Sensori TPMS universali sens.it Alligator**  
**Alligator sens.it TPMS universal sensors**  
**Senseurs TPMS universels sens.it Alligator**

Codice Code Code	Descrizione Description Description	Note Note Note	Quantità minima Minimum quantity Quantité minimum
3040029	Tool di programmazione Programming tool Outil de programmation	Il tool è connesso ad una porta USB standard che utilizza l'applicazione sens.it Alligator. In meno di 60 secondi, specificando solo il numero di identificazione del veicolo e l'ID del sensore originale, il sensore universale 3040029D viene riprogrammato ed è pronto per l'installazione. <i>The tool is connected to a standard USB port using the Alligator sens.it application. In less than 60 seconds, entering only the vehicle identification number and the OE sensor ID, the universal sensor 3040029D is reprogrammed and ready for installation.</i> <i>L'outil est branché à une porte USB standard qui utilise l'application sens.it Alligator. En moins de 60 secondes, en spécifiant seulement le numéro d'identification du véhicule et l'ID du senseur original, le senseur universel 3040029D est ré-programmé et il est prêt pour l'installation.</i>	1
3040029D	Sensore per valvole in metallo 434 MHz Sensor for metal valves 434 MHz Senseur pour valves en métal 434 MHz	Sensore universale basato sulla funzionalità Clamp-in che consente la regolazione dell'angolo di montaggio di 12°-40° assicurando compatibilità con tutti i cerchi in ferro e lega. <i>Universal sensor based on Clamp-in functionality, which allows adjustment in a range of 12°-40° to fit all steel and alu rims.</i> <i>Senseur universel basé sur la fonctionnalité Clamp-in qui permet le réglage de l'angle de montage de 12°-40° en assurant compatibilité avec toutes jantes en acier et en alliage.</i>	1
3040029M	Valvola alluminio Aluminum valve Valve aluminium	Valvola in alluminio anodizzato 43mm, disponibile in diverse finiture (incluso cromata e nera). <i>Aluminum valve 43mm protected by an anodized coating Available in a range of finishes (including chrome and black).</i> <i>Valve en aluminium éloxé 43mm, disponible en finissages différents (incluant chromage et noir).</i>	
3040029W	TPMS Sens.it kit di montaggio TPMS Sens.it mounting tool kit TPMS Sens.it kit de montage	Contiene: adattatore 1/4", chiave torsiometrica tarata, regolata a 3,3 Nm (29" lbs), punte di torsione dimensioni 15 e 20, supporto valvola, chiavi esagonali 11 mm / 12 mm, maneggevole sacca con tracolla. <i>It contains: 1/4" adapter, calibrated torque wrench, adjusted to 3,3 Nm (29 inch lbs), torx bits sizes 15 and 20, valve holder, Hex Sockets 11 mm / 12 mm, handy belt-pouch.</i> <i>Il contient: adaptateur 1/4", clef torsiométrique calibrée, réglée à 3,3 Nm (29" lbs), pointes de torsion dimensions 15 et 20, support valve, clefs hexagonales 11 mm / 12 mm, sac maniable avec courroie.</i>	1
3040029Z	Starter kit TPMS Sens.It Starter kit TPMS Sens.It Starter kit TPMS Sens.It	Contiene: 1 base programmazione, 8 valvole argento, 8 sensori. <i>It contains: 1 pad, 8 silver valves, 8 sensors.</i> <i>Il contient: 1 base de programmation, 8 valves argent, 8 senseurs.</i>	1

Il nuovo sensore TPMS sens.it, con 1 solo modello di sensore e 1 sola tipologia di valvole, è compatibile con oltre il 90% dei sensori TPMS originali. A differenza di altre soluzioni non richiede la gestione di numerose parti di ricambio e semplifica l'assistenza pneumatico.

The new sens.it TPMS sensor, through only 1 sensor and 1 valve options, offers coverage for more than 90% of OE TPMS. Unlike other solutions, it doesn't require to stock many parts and simplify the tyre service activity.

Le nouveau senseur TPMS sens.it avec seulement 1 modèle de senseur et 1 type de valve, est compatible avec outre 90% des senseurs TPMS originaux. Différemment d'autres solutions, il ne demande pas la gestion de nombreuses pièces de rechange et il simplifie l'assistance au pneu.

**Valvole HUF indicatrici di pressione per cerchi in alluminio**  
**HUF pressure indicating valves for alu rims**  
**Valves HUF indicatrices de pression pour jantes en aluminium**

Codice Code Code	Descrizione Description Description	Modello Model Modèle	Lungh. mm Length in mm Longueur en mm	Colore Colour Couleur	Quantità minima Minimum quantity Quantité minimum
3040030A	Valvola indicatrice di pressione Pressure indicating valve Valve indicatrice de pression	RDV 001	43	Nessuno None/Aucune	20
3040030C	Valvola indicatrice di pressione Pressure indicating valve Valve indicatrice de pression	RDV 002	48	Verde Green/Vert	20
3040030D	Valvola indicatrice di pressione Pressure indicating valve Valve indicatrice de pression	RDV 003	49	Nero Black/Noir	20
3040030F	Valvola indicatrice di pressione Pressure indicating valve Valve indicatrice de pression	RDV 004	51	Arancione Orange/Orangé	20
3040030G	Valvola indicatrice di pressione Pressure indicating valve Valve indicatrice de pression	RDV 005	56	Giallo Yellow/Jaune	20



**Radiocontrolli HUF/HUF radio controls/Radio contrôles HUF**

Codice Code Code	Descrizione Description Description	Modello Model Modèle	Serraggio dado Serrage Ecrou Nut torque (N.m)	Serraggio vite Serrage vis Screw torque (N.m)
3040032A	Radiocontrollo Radio control / Radio contrôle	RDE 001 (433 MHz)	4	4
3040032C	Radiocontrollo Radio control / Radio contrôle	RDE 002 (433 MHz)	4	4
3040032D	Radiocontrollo Radio control / Radio contrôle	RDE 004 (433 MHz)	4	4
3040032E	Radiocontrollo Radio control / Radio contrôle	RDE 003 (433 MHz)	4	4
3040032F	Radiocontrollo Radio control / Radio contrôle	RDE 005 (433 MHz)	4	4
3040032H	Radiocontrollo Radio control / Radio contrôle	RDE 008 (433 MHz)	4	4
3040032J	Radiocontrollo / Radio control Radio controle	RDE 010 (433 MHz)	4	4
3040032L	Radiocontrollo / Radio control Radio controle	RDE 011 (433 MHz)	4	4
3040032N	Radiocontrollo / Radio control Radio controle	RDE 012 (433 MHz)	4	4
3040032P	Radiocontrollo / Radio control Radio controle	RDE 013 (433 MHz)	4	4
3040032S	Radiocontrollo / Radio control Radio controle	RDE 017 (433 MHz)	4	4
3040032T	Radiocontrollo / Radio control Radio controle	RDE 018 (433 MHz)	4	4



- Le valvole sono abbinabili ad ogni tipo di radiocontrollo RDE; la lunghezza della valvola dipende dal tipo di cerchio.
- Valves can be coupled to any kind of RDE radio control; the valve length depends on the type of rim.
- Les valves peuvent être accouplées à tous types de radio contrôle RDE; la longueur de la valve dépend du type de jante.

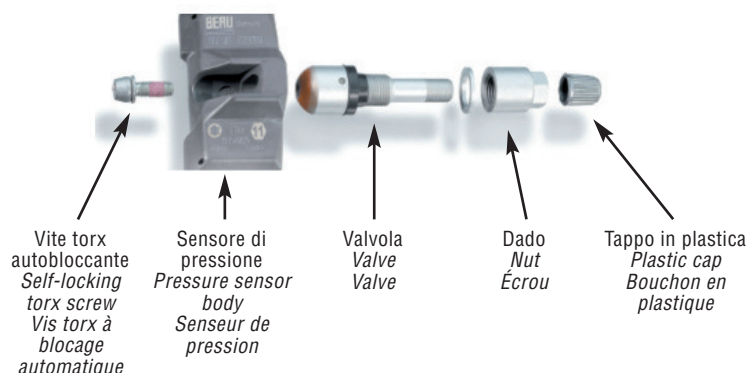

**Applicazione ed utilizzo radiocontrolli HUF**  
**Application and use of HUF radio controls**  
**Application et utilisation des radio contrôles HUF**

Veicolo Vehicles Vehicules	Data di produzione Manufacturing date Dates de production	Nota Remark Note	Tipo Type Type
<b>ALFA ROMEO</b>			
Alfa 8C (920)	2007 -> 2009	--	RDE001
<b>AUDI</b>			
A4 (8E) / S4 / Avant / Quattro	11/2004 -> 10/2007	--	RDE007
A4 Cabrio	11/2004 -> 07/2008	--	RDE007
A6 Allroad (4B)	04/2000 -> 08/2005	--	RDE001
A6 Allroad (4F)	05/2006 -> 05/2009	fino a/ up to / jusq'au chassis N° 4F-9-043 000	RDE007
A6 Allroad (4F)	06/2009 ->	da/ from /à partir du chassis N° 4F-9-043 001	RDE011
A6 (4F) / S6 / Avant / Quattro	05/2004 -> 05/2009	fino a/ up to / jusq'au chassis N° 4F-9N043 000 - 4F-9Y000 220	RDE007
A6 (4F) / S6 / Avant / Quattro	06/2009 ->	da/ from /à partir du chassis N° 4F-9N043 001 - 4F-9Y000 221	RDE011
A8 / S8 (4D), (D2)	09/1999 -> 09/2002	--	RDE001
A8 / S8 (4E), (D3)	10/2002 ->	--	RDE001
R8	05/2007 -> 05/2009	fino a/ up to / jusq'au chassis N° 42-9-003 540	RDE007
R8	06/2009 ->	da/ from /à partir du chassis N° 42-9-003 541	RDE011
RS6, RS6 plus	04/2000 ->	--	RDE001
RS4 (8E) / Cabrio / Avant / Quattro	05/2006 ->	--	RDE007
Q7 (4L)	09/2005 -> 05/2009	fino a/ up to / jusq'au chassis N° 4L-9-036 000	RDE007
Q7 (4L)	06/2009 ->	da/ from /à partir du chassis N° 4L-9-036 001	RDE011
<b>BENTLEY</b>			
Continental GT (614)	09/2003 -> 05/2005	--	RDE001
Continental GT (614)	06/2005 ->	--	RDE007
Continental Flying Spur (611)	04/2005 ->	--	RDE007
<b>BMW</b>			
Série 3 (E46)	03/1999 -> 12/2004	--	RDE002
Série 5 (E39)	09/1998 -> 07/2003	--	RDE002
Série 5 (F10) ECE - Limousine: 520d, 523i (N52N, N53), 525d, 528i (N52N, N53) 530d, 535d, 535i, 550i, 550X	09/2010 ->	--	RDE012
Série 5 (F11) ECE-Touring: 520d, 523i (N52N, N53), 525d, 528i (N52N, N53) 530d, 535d, 535i	09/2010 ->	--	RDE012
Série 5 GT (F07) ECE: 530d, 530dX, 535d, 535dX, 535i, 535iX, 550i, 550iX	09/2010 ->	--	RDE012
X5 (E53)	10/1999 -> 04/2004	--	RDE003
Série 7 (E38)	09/1998 -> 10/2001	--	RDE002
Série 7 (E65)	11/2001 -> 11/2003	--	RDE002
Série 7 (F01) Limousine ECE: 730d, 730i, 740d, 740dX, 740i, 750i, 750iX, 760i	09/2010 ->	--	RDE012
Série 7 (F02) Limousine ECE: 730Ld, 730Li, 740Li, 750Li, 750LiX, 760Li	09/2010 ->	--	RDE012
Série 7 (F04) -Hybrid Limousine ECE: Hybrid 7, 7L	09/2010 ->	--	RDE012
<b>FERRARI</b>			
California (F149)	2009 ->	--	RDE010
550 Maranello Evo- luzione (F133e)	03/2002 ->	--	RDE001
575 M-Maranello	2002 -> 2006	--	RDE001
Enzo (F140)	2003 -> 2004	--	RDE005
Ferrari 612 Scaglietti (F137)	03/2004 ->	--	RDE001
Ferrari 599 GTB (F141)	03/2004 ->	--	RDE001
Ferrari F430 (F131e)	09/2005 -> 06/2007	--	RDE001
Ferrari F430 (F131e) Europe	07/2007 ->	--	RDE001
458 Italia (F142)	2009 ->	--	RDE010
Ferrari FXX	2005 -> 2006	--	RDE005

Veicolo Vehicles Vehicules	Data di produzione Manufacturing date Dates de production	Nota Remark Note	Tipo Type Type
<b>LAND ROVER</b>			
Range Rover (L30)	03/2002 -> 02/2003	--	RDE003
<b>MAYBACH</b>			
Maybach 57	10/2002 ->	--	RDE001
Maybach 62	10/2002 ->	--	RDE001
<b>MERCEDES</b>			
AMG E-Class (W210 AMG)	07/1999 -> 03/2002	--	RDE001
CLS (C219)	10/2004 -> 06/2005	--	RDE001
E-Class (W211)	03/2002 -> 06/2005	--	RDE001
S-Class coupé (C215)	07/1999 -> 09/2005	--	RDE001
S-Class (W220)	07/1999 -> 09/2005	--	RDE001
SL-Roadster (R230)	10/2001 -> 05/2005	--	RDE001
SLR (R199)	04/2004 ->	--	RDE001
<b>PORSCHE</b>			
Boxster (987)	2005 -> 2008	Chassis N° WPO ZZZ 98 Z 5 5 - WPO ZZZ 98 Z 6 5 WPO ZZZ 98 Z 7 5 - WPO ZZZ 98 Z 8 5	RDE001
Boxster (987-2)	11/2008 -> 2009	Chassis N° WPO ZZZ 99 S 9 S	RDE010
911 (997-1 Carrera)	02/2005 -> 03/2008	--	RDE001
911 (997-2 Carrera)	2009 ->	--	RDE010
911 (997T - Turbo)	2007 -> 2009	--	RDE001
911 (997T2 - Turbo)	2010 ->	--	RDE010
997 (GT3-2)	2007 -> 2009	--	RDE001
997 (GT3-2)	2010 ->	--	RDE010
Panamera (970)	09/2009 ->	--	RDE010
Carrera GT	2003 -> 2006	--	RDE001
Cayenne (955 - 9PA)	12/2002 -> 12/2006	Chassis N° WPO ZZZ 9 PA 3 L - WPO ZZZ 9 PA 4 L WPO ZZZ 9 PA 5 L - WPO ZZZ 9 PA 6 L	RDE005
Cayenne (955 - 9PA1)	01/2007 ->	Chassis N° WPO ZZZ 9 PA 7 L - WPO ZZZ 9 PA 8 L WP1 ZZZ 9 PA 7 L - WP1 ZZZ 9 PA 8 L	RDE007
Cayenne (955 - 92A)	08/2009 -> 2010	Chassis N° WPO ZZZ 9 PA A L A = année/year 2010 B = année/year 2011	RDE011
Cayman (987C)	11/2005 -> 2008	Chassis N° WPO ZZZ 98 Z 6	RDE001
Cayman (987C2)	01/2009 ->	Chassis N° WPO ZZZ 98 Z 9	RDE010
<b>VOLKSWAGEN</b>			
Phaeton	06/2002 -> 05/2007	--	RDE001
Phaeton (3D)	06/2007 -> 05/2010	Chassis N° 3D-8-000 001 -> 3D-9-100 001 3D-A-000 001 -> 3D-A-100 001	RDE007
Phaeton (2011)	06/2010 ->	Chassis N° 3D-B-000 001 -> 3D-B-100 000	RDE011
Touareg (7L)	11/2002 -> 12/2006	Chassis N° 7L-7-06 06 22	RDE005
Touareg	01/2007 -> 12/2009	Chassis N° 7L-7-06 06 23	RDE007
Touareg 2011	01/2010 ->	Chassis N° 7P-B-000001 -> 7P-B-070 001	RDE011
Passat CC	11/2010 ->	--	RDE013



- Consultare il sito web [www.italmatic.net](http://www.italmatic.net) per la lista completa ed aggiornata.  
- Please visit web site [www.italmatic.net](http://www.italmatic.net) to download the complete and up-to-date list.  
- S'il vous plait visitez le site web [www.italmatic.net](http://www.italmatic.net) pour télécharger le tableau complet et mis à jour.

**Valvole TPMS indicatrici di pressione Schrader e VDO**  
**TPMS pressure indicating valves Schrader and VDO**  
**Valves TPMS capteurs de pression Schrader et VDO**



**Nota/Note/Note:**

- (A) Tool di diagnosi deve essere usato per riprogrammare il codice ID del nuovo sensore.  
*Diagnosis tool must be used to reprogram the ID code of the new sensor(s).*  
*Utiliser un outil de diagnostic pour la reprogrammation du/des capteur(s).*
- (B) Riprogrammazione automatica del sensore ID (usare il tool di diagnosi se è disponibile la connessione OBD).  
*Automatic reprogramming of the sensor ID code (use diagnostic tool if OBD connection is available).*  
*Reprogrammation automatique du capteur (utiliser un outil de diagnostic si connexion OBD disponible).*
- (C) La posizione delle valvole è identificata con il colore dell'anello.  
*The position of the vehicle valves is identified by color rings.*  
*Position des valves sur le véhicule identifiée par des bagues de couleur.*
- (D) Per la riprogrammazione del ID del sensore, fare riferimento al manuale del veicolo.  
*For sensor ID code reprogramming, refer to the vehicle user manual.*  
*Pour la reprogrammation des capteurs, se reporter à la notice du véhicule.*

Veicolo Vehicle Vehicule	Data di produzione Manufacturing date Date de production	ID Sensore Sensor ID Capteur ID	Sensore completo Complete sensor Capteur complet	Tipo Type Type	Kit accessori Service Kit Accessoires reveunte	Nm dado Nm nut Nm écrou	Nm vite Nm screw Nm vis	Nota Note Note
<b>CADILLAC</b>								
CTS	2006 --> 2007	25774007	<b>66050-67</b>	(2)	<b>66700-KD</b>	8	--	A
CTS	2008 -->	20922901	<b>66074-67</b>	(7)	cappelletto/cap/bouchon R 1424-3 interno/core/méca 37992-69 corpo/body/corps + vite/screw/vis 66118-68	--	1,4	A
SRX	2005 --> 2006	25774007	<b>66050-67</b>	(2)	<b>66700-KD</b>	8	--	A
STS	2005 --> 2008	25758221	<b>66116-67</b>	(2)	<b>66700-KD</b>	8	--	D
XLR	2004 --> 2009	25758221	<b>66116-67</b>	(2)	<b>66700-KD</b>	8	--	D
<b>CHEVROLET</b>								
Camaro	2012 -->	20925925	<b>66543-67</b>	(2)	<b>66700-KD</b>	8	--	A
Corvette	2005 --> 2009	25758221	<b>66116-67</b>	(2)	<b>66700-KD</b>	8	--	D
Corvette	2010 --> 2012	20925925	<b>66543-67</b>	(2)	<b>66700-KD</b>	8	--	A
Trailblazer	2007 --> 2008	25774007	<b>66050-67</b>	(2)	<b>66700-KD</b>	8	--	A
<b>CHRYSLER</b>								
300 C	06/2006 -->	56029359AA-AB/ 56053031AC/ 56029481AA-AB	<b>65722-67</b>	(3) (7)	<b>66699-KD</b> corpo/body/corps 43148-67 cappelletto/cap/bouchon R 1424-3 interno/core/méca 37992-69 corpo/body/corps + vite/screw/vis 66150-68	6	1,4	B
300	2009 --> 2010	56029400AC-AD	<b>66113-67</b>	(3)	<b>66138-KD</b>	6	--	B
300	2011 -->	56029398AA-AB	<b>66073-67</b>	(7)	cappelletto/cap/bouchon R 1424-3 interno/core/méca 37992-69 corpo/body/corps + vite/screw/vis 66150-68	--	1,4	B
Sebring	06-2006 -->	56029359AA-AB/ 56053031AC/ 56029481AA-AB	<b>65722-67</b>	(3) (7)	<b>66699-KD</b> corpo/body/corps 43148-67 cappelletto/cap/bouchon R 1424-3 interno/core/méca 37992-69 corpo/body/corps + vite/screw/vis 66150-68	6	1,4	B
Town & country van	2011 -->	56029398AA-AB	<b>66073-67</b>	(7)	cappelletto/cap/bouchon R 1424-3 interno/core/méca 37992-69 corpo/body/corps + vite/screw/vis 66150-68	--	1,4	B
Voyager	07/2007 -->	56029359AA-AB/ 56053031AC/ 56029481AA-AB	<b>65722-67</b>	(3) (7)	<b>66699-KD</b> corpo/body/corps 43148-67 cappelletto/cap/bouchon R 1424-3 interno/core/méca 37992-69 corpo/body/corps + vite/screw/vis 66150-68	6	1,4	B

**Nota/Note/Note:**

Documentazione non contrattuale / Italmatic si riserva il diritto d'apportare tutte le modifiche a questa documentazione o ai prodotti elencati senza preavviso.  
*Uncontractual document / Italmatic reserves the right to modify this document and/or the products described therein without notice.*  
*Document non contractuel / Italmatic se réserve le droit d'apporter toutes modifications à cette documentation ou aux produits eux-mêmes et ceci sans préavis.*

Consultare il sito web [www.italmatic.net](http://www.italmatic.net) per scaricare la tabella aggiornata / Please visit web site [www.italmatic.net](http://www.italmatic.net) to download the up-to-date table  
*S'il vous plaît, visiter le site web [www.italmatic.net](http://www.italmatic.net) pour télécharger le tableau mis à jour.*



**VALVOLE ED ACCESSORI**  
**VALVES AND ACCESSORIES**  
**VALVES ET ACCESSOIRES**

Veicolo Vehicle Vehicule	Data di produzione Manufacturing date Date de production	ID Sensore Sensor ID Capteur ID	Sensore completo Complete sensor Capteur complet	Tipo Type Type	Kit accessori Service Kit Accessoires revente	Nm dado Nm nut Nm écrou	Nm vite Nm screw Nm vis	Nota Note Note
<b>CITROEN</b>								
Berlingo	2009 -->	9683420380	<b>65597-67</b>	(7)	cappelletto/cap/bouchon R 1424-3 interno/core/méca <b>37992-69</b> corpo/body/corps + vite/screw/vis <b>66118-68</b>	--	1,4	A
C4 & C4 coupé	11/2004 --> 07/2008	S120123004	<b>65396-67</b>	(4)	<b>65659-KD</b>	8	--	A
C4	08/2008 -->	9683420380	<b>65597-67</b>	(7)	cappelletto/cap/bouchon R 1424-3 interno/core/méca <b>37992-69</b> corpo/body/corps + vite/screw/vis <b>66118-68</b>	--	1,4	A
Picasso C4	09/2006 -->	9683420380	<b>65597-67</b>	(7)	cappelletto/cap/bouchon R 1424-3 interno/core/méca <b>37992-69</b> corpo/body/corps + vite/screw/vis <b>66118-68</b>	--	1,4	A
Picasso C4 restylé	08/2008 -->	9683420380	<b>65597-67</b>	(7)	cappelletto/cap/bouchon R 1424-3 interno/core/méca <b>37992-69</b> corpo/body/corps + vite/screw/vis <b>66118-68</b>	--	1,4	A
C5	03/2001 --> 07/2004	--	<b>60311-67</b>	(1)	<b>65656-KD</b>	4,25	--	A
C5 II	08/2004 --> 01/2008	S120123004	<b>65396-67</b>	(4)	<b>65659-KD</b>	8	--	A
C5 III	02/2008 -->	S120123004	<b>65396-67</b>	(4)	<b>65659-KD</b>	8	--	A
C6	09/2005 -->	S120123004	<b>65396-67</b>	(4)	<b>65659-KD</b>	8	--	A
C8	06/2002 --> 09/2005	9634866180	<b>60311-67</b>	(1)	<b>65656-KD</b>	4,25	--	A
C8	10/2005 -->	S120123004	<b>65396-67</b>	(4)	<b>65659-KD</b>	8	--	A
DS4	12/2010 -->	9683420380	<b>65597-67</b>	(7)	cappelletto/cap/bouchon R 1424-3 interno/core/méca <b>37992-69</b> corpo/body/corps + vite/screw/vis <b>66118-68</b>	--	1,4	A
DS5	01/2011 -->	9683420380	<b>65597-67</b>	(7)	cappelletto/cap/bouchon R 1424-3 interno/core/méca <b>37992-69</b> corpo/body/corps + vite/screw/vis <b>66118-68</b>	--	1,4	A
<b>DODGE</b>								
Caliber	mi-2007 -->	56029359AA-AB/ 56053031AC/ 56029481AA-AB	<b>65722-67</b>	(3) (7)	<b>66699-KD</b> corpo/body/corps <b>43148-67</b> cappelletto/cap/bouchon R 1424-3 interno/core/méca <b>37992-69</b> corpo/body/corps + vite/screw/vis <b>66150-68</b>	6	--	B
Challenger	2008 --> 2009	56029400AB-AC-AD	<b>66113-67</b>	(3)	<b>66138-KD</b>	6	--	B
Challenger	2010 -->	56029398AA-AB	<b>66073-67</b>	(7)	cappelletto/cap/bouchon R 1424-3 interno/core/méca <b>37992-69</b> corpo/body/corps + vite/screw/vis <b>66150-68</b>	--	1,4	B
Charger	2009	56029400AC	<b>66113-67</b>	(3)	<b>66138-KD</b>	6	--	B
Charger	2010 -->	56029398AA-AB	<b>66073-67</b>	(7)	cappelletto/cap/bouchon R 1424-3 interno/core/méca <b>37992-69</b> corpo/body/corps + vite/screw/vis <b>66150-68</b>	--	1,4	B
Dakota	2009-->	56029359AA-AB/ 56053031AC/ 56029481AA-AB	<b>65722-67</b>	(3) (7)	<b>66699-KD</b> corpo/body/corps <b>43148-67</b> cappelletto/cap/bouchon R 1424-3 interno/core/méca <b>37992-69</b> corpo/body/corps + vite/screw/vis <b>66150-68</b>	6	1,4	B
Durango	2011 -->	56029398AA-AB	<b>66073-67</b>	(7)	cappelletto/cap/bouchon R 1424-3 interno/core/méca <b>37992-69</b> corpo/body/corps + vite/screw/vis <b>66150-68</b>	--	1,4	B
Grand caravan	2011 -->	56029398AA-AB	<b>66073-67</b>	(7)	cappelletto/cap/bouchon R 1424-3 interno/core/méca <b>37992-69</b> corpo/body/corps + vite/screw/vis <b>66150-68</b>	--	1,4	B
Journey	2011 -->	56029398AA-AB	<b>66073-67</b>	(7)	cappelletto/cap/bouchon R 1424-3 interno/core/méca <b>37992-69</b> corpo/body/corps + vite/screw/vis <b>66150-68</b>	--	1,4	B
Nitro	mi-2007 -->	56029359AA-AB/ 56053031AC/ 56029481AA-AB	<b>65722-67</b>	(3) (7)	<b>66699-KD</b> corpo/body/corps <b>43148-67</b> cappelletto/cap/bouchon R 1424-3 interno/core/méca <b>37992-69</b> corpo/body/corps + vite/screw/vis <b>66150-68</b>	6	1,4	B
Ram series Pickup	2010 -->	56029398AA-AB	<b>66073-67</b>	(7)	cappelletto/cap/bouchon R 1424-3 interno/core/méca <b>37992-69</b> corpo/body/corps + vite/screw/vis <b>66150-68</b>	--	1,4	B
<b>FIAT</b>								
Freemont	2011 -->	56029398AA-AB	<b>66073-67</b>	(7)	cappelletto/cap/bouchon R 1424-3 interno/core/méca <b>37992-69</b> corpo/body/corps + vite/screw/vis <b>66150-68</b>	--	1,4	B
Ulysse	06/2002 --> 09/2005	--	<b>60311-67</b>	(1)	<b>65656-KD</b>	4,25	--	A
Ulysse Nuovo 2F	10/2005 --> 12/2010	S120123004	<b>65396-67</b>	(4)	<b>65659-KD</b>	8	--	A
<b>FORD</b>								
Explorer	01-2011 -->	BB5T-1A180-AA	<b>66137-67</b>	(7)	cappelletto/cap/bouchon R 1424-3 interno/core/méca <b>37992-69</b> corpo/body/corps + vite/screw/vis <b>66150-68</b>	--	1,4	A
Galaxy	05/2006 -->	S180052020	<b>66042-67</b>	(5)	<b>66070-KU</b>	8	--	B
Mondeo IV	03/2007 -->	S180052020	<b>66042-67</b>	(5)	<b>66070-KU</b>	8	--	B

<b>Veicolo</b> <i>Vehicle</i> <i>Vehicule</i>	<b>Data di produzione</b> <i>Manufacturing date</i> <i>Date de production</i>	<b>ID Sensore</b> <i>Sensor ID</i> <i>Capteur ID</i>	<b>Sensore completo</b> <i>Complete sensor</i> <i>Capteur complet</i>	<b>Tipo</b> <i>Type</i> <i>Type</i>	<b>Kit accessori</b> <i>Service Kit</i> <i>Accessoires revente</i>	<b>Nm dado</b> <i>Nm nut</i> <i>Nm écrou</i>	<b>Nm vite</b> <i>Nm screw</i> <i>Nm vis</i>	<b>Nota</b> <i>Note</i> <i>Note</i>
<b>FORD</b>								
Navigator	01-2011 -->	BB5T-1A180-AA	<b>66137-67</b>	(7)	cappelletto/cap/bouchon R 1424-3 interno/core/méca <b>37992-69</b> corpo/body/corps + vite/screw/vis <b>66150-68</b> <b>66070-KU</b>	--	1,4	A
S-Max	05/2006 -->	S180052020	<b>66042-67</b>	(5)		8	--	B
<b>HYUNDAI</b>								
i20	09/2008 -->	S180052012	<b>66040-67</b>	(5)	<b>66071-KU</b>	8	--	B
i30	2007 -->		<b>65767-67</b>	(4)	<b>65768-KU</b>	8	--	B
i30 cw	2009 -->		<b>65767-67</b>	(4)	<b>65768-KU</b>	8	--	B
ix20	2010 -->	S180052012	<b>66040-67</b>	(5)	<b>66071-KU</b>	8	--	B
Veloster	03/2011 -->	52933-2V000	<b>66128-67</b>	(7)	cappelletto/cap/bouchon R 1424-3 interno/core/méca <b>37992-69</b> corpo/body/corps + vite/screw/vis <b>66118-68</b>	--	1,4	A
<b>INFINITY</b>								
G37 Sedan	06/2008 -->	40700JY00B	<b>65938-67</b>	(1)	<b>65961-KD</b>	8	--	A
G37 Coupe	06/2008 -->	40700JY00B	<b>65938-67</b>	(1)	<b>65961-KD</b>	8	--	A
J50 EX37	06/2008 -->	40700JY00B	<b>65938-67</b>	(1)	<b>65961-KD</b>	8	--	A
S51 FX37	06/2008 -->	40700JY00B	<b>65938-67</b>	(1)	<b>65961-KD</b>	8	--	A
<b>JAGUAR</b>								
XF	11/2007 -->	S180052022	<b>66043-67</b>	(5)	<b>66070-KU</b>	8	--	B
XJ (X350)	08/2005 -->	S180052022	<b>66043-67</b>	(5)	<b>66070-KU</b>	8	--	B
XK New	01/2006 -->	S180052022	<b>66043-67</b>	(5)	<b>66070-KU</b>	8	--	B
X-Type	2007 -->	S180052022	<b>66043-67</b>	(5)	<b>66070-KU</b>	8	--	B
<b>JEEP</b>								
Commander	06-2006 --> 12/2010	56029359AA-AB/ 56053031AC/ 56029481AA-AB	<b>65722-67</b>	(3) (7)	<b>66699-KD</b> corpo/body/corps <b>43148-67</b> cappelletto/cap/bouchon R 1424-3 interno/core/méca <b>37992-69</b> corpo/body/corps + vite/screw/vis <b>66150-68</b>	6	1,4	B
Grand Cherokee	06-2006 --> 12/2010	56029359AA-AB/ 56053031AC/ 56029481AA-AB	<b>65722-67</b>	(3) (7)	<b>66699-KD</b> corpo/body/corps <b>43148-67</b> cappelletto/cap/bouchon R 1424-3 interno/core/méca <b>37992-69</b> corpo/body/corps + vite/screw/vis <b>66150-68</b>	6	1,4	B
Grand Cherokee	01/2011 -->	56029398AA-AB	<b>66073-67</b>	(7)	cappelletto/cap/bouchon R 1424-3 interno/core/méca <b>37992-69</b> corpo/body/corps + vite/screw/vis <b>66150-68</b>	--	1,4	B
Liberty	01/2010 -->	56029481AA-AB	<b>66073-67</b>	(7)	cappelletto/cap/bouchon R 1424-3 interno/core/méca <b>37992-69</b> corpo/body/corps + vite/screw/vis <b>66150-68</b>	--	1,4	B
Wrangler	07/2007 --> 08/2010	56029359AA-AB/ 56053031AC/ 56029481AA-AB	<b>65722-67</b>	(3) (7)	<b>66699-KD</b> corpo/body/corps <b>43148-67</b> cappelletto/cap/bouchon R 1424-3 interno/core/méca <b>37992-69</b> corpo/body/corps + vite/screw/vis <b>66150-68</b>	6	1,4	B
Wrangler	09/2010 -->	56029398AB	<b>66073-67</b>	(7)	cappelletto/cap/bouchon R 1424-3 interno/core/méca <b>37992-69</b> corpo/body/corps + vite/screw/vis <b>66150-68</b>	--	1,4	B
<b>KIA</b>								
Cee'd - Procee'd	2007 --> 2011		<b>65767-67</b>	(4)	<b>65768-KU</b>	8	--	B
Optima 11	2011 -->	S180052012	<b>66040-67</b>	(5)	<b>66071-KU</b>	8	--	B
Optima hybrid								
Sorento	11/2009 -->	S180052012	<b>66040-67</b>	(5)	<b>66071-KU</b>	8	--	B
Soul 1.6 CVVT	10/2008 -->	S180052012	<b>66040-67</b>	(5)	<b>66071-KU</b>	8	--	B
Venga	02/2010 -->	S180052012	<b>66040-67</b>	(5)	<b>66071-KU</b>	8	--	B
<b>LANCIA</b>								
Phedra	06/2002 --> 09/2005	--	<b>60311-67</b>	(1)	<b>65656-KD</b>	4,25	--	A
Phedra	10/2005 --> 12/2010	S120123004	<b>65396-67</b>	(4)	<b>65659-KD</b>	8	--	A
Thema	10/2011 -->	56029398AB	<b>66073-67</b>	(7)	cappelletto/cap/bouchon R 1424-3 interno/core/méca <b>37992-69</b> corpo/body/corps + vite/screw/vis <b>66150-68</b>	--	1,4	B
Voyager	2011 -->	56029398AB	<b>66073-67</b>	(7)	cappelletto/cap/bouchon R 1424-3 interno/core/méca <b>37992-69</b> corpo/body/corps + vite/screw/vis <b>66150-68</b>	--	1,4	B
<b>LAND ROVER</b>								
Discovery	2005 -->	S180052022/S120123002	<b>65741-67</b>	(4)	<b>65659-KD</b>	8	--	B
Evoque	07/2011 -->	S180052022/S120123002	<b>65741-67</b>	(4)	<b>65659-KD</b>	8	--	B
FreeLander	2005 -->	S180052022/S120123002	<b>66043-67</b>	(5)	<b>66070-KU</b>	8	--	B
Range Rover	02/2005 -->	S180052022/S120123002	<b>65741-67</b>	(4)	<b>65659-KD</b>	8	--	B
Range Rover Vogue	2005 -->	S180052022/S120123002	<b>65741-67</b>	(4)	<b>65659-KD</b>	8	--	B

**VALVOLE ED ACCESSORI**  
**VALVES AND ACCESSORIES**  
**VALVES ET ACCESSOIRES**

Veicolo Vehicle Vehicule	Data di produzione Manufacturing date Date de production	ID Sensore Sensor ID Capteur ID	Sensore completo Complete sensor Capteur complet	Tipo Type Type	Kit accessori Service Kit Accessoires revente	Nm dado Nm nut Nm écrou	Nm vite Nm screw Nm vis	Nota Note Note
<b>LOTUS</b>								
Elise	01/2008 -->	13227143/ 12825085	<b>65717-67</b>	(1)	<b>65657-KD</b>	7,5	--	B
Evora	01/2010 -->	13227143/ 12825085	<b>65717-67</b>	(1)	<b>65657-KD</b>	7,5	--	B
Exige	01/2008 -->	13227143/ 12825085	<b>65717-67</b>	(1)	<b>65657-KD</b>	7,5	--	B
<b>MAZDA</b>								
CX7	10/2009 -->	S80052018	<b>66041-67</b>	(5)	<b>66072-KU</b>	8	--	B
MX5	03/2010 -->	S80052018	<b>66041-67</b>	(5)	<b>66072-KU</b>	8	--	B
3	06/2009 -->	S80052018	<b>66041-67</b>	(5)	<b>66072-KU</b>	8	--	B
5	2010 -->	S80052018	<b>66041-67</b>	(5)	<b>66072-KU</b>	8	--	B
6	02/2008 -->	S80052018	<b>66041-67</b>	(5)	<b>66072-KU</b>	8	--	B
<b>MERCEDES</b>								
AMG (W197 + other)	01/2010 -->	A0025409017/ A0035400217/ A0009054100	<b>65971-67</b> cerchi lega/Alu rims/ jantes alu <b>65970-67</b> cerchi ferro/steel rims/jantes tôle	(3)	<b>65962-KD</b> cerchi lega/jantes alu/Alu rims <b>65964-KD</b> cerchi ferro/jantes tôle/Steel rims	6	--	B
C-Class (204)	01/2008 --> 12/2016	A0025409017/ A0035400217/ A0009054100	<b>65971-67</b> cerchi lega/Alu rims/ jantes alu <b>65970-67</b> cerchi ferro/steel rims/jantes tôle	(3)	<b>65962-KD</b> cerchi lega/jantes alu/Alu rims <b>65964-KD</b> cerchi ferro/jantes tôle/Steel rims	6	--	B
CL-Class (216)	06/2009 --> 12/2012	A0025409017/ A0035400217/ A0009054100	<b>65971-67</b> cerchi lega/Alu rims/ jantes alu <b>65970-67</b> cerchi ferro/steel rims/jantes tôle	(3)	<b>65962-KD</b> cerchi lega/jantes alu/Alu rims <b>65964-KD</b> cerchi ferro/jantes tôle/Steel rims	6	--	B
CLK (W209)	04/2007 --> 09/2009	A0025409017/ A0035400217/ A0009054100	<b>65971-67</b> cerchi lega/Alu rims/ jantes alu <b>65970-67</b> cerchi ferro/steel rims/jantes tôle	(3)	<b>65962-KD</b> cerchi lega/jantes alu/Alu rims <b>65964-KD</b> cerchi ferro/jantes tôle/Steel rims	6	--	B
CLK (W207)	10/2009 -->	A0025409017/ A0035400217/ A0009054100	<b>65971-67</b> cerchi lega/Alu rims/ jantes alu <b>65970-67</b> cerchi ferro/steel rims/jantes tôle	(3)	<b>65962-KD</b> cerchi lega/jantes alu/Alu rims <b>65964-KD</b> cerchi ferro/jantes tôle/Steel rims	6	--	B
CLS (W219)	2005 --> 06/2009	S122228002	<b>65646-67</b>	(6)	<b>65661-KU</b>	6	--	B
CLS (W218)	06/2009 --> 12/2016	A0009054100	<b>65971-67</b> cerchi lega/Alu rims/ jantes alu <b>65970-67</b> cerchi ferro/steel rims/jantes tôle	(3)	<b>65962-KD</b> cerchi lega/jantes alu/Alu rims <b>65964-KD</b> cerchi ferro/jantes tôle/Steel rims	6	--	B
E-Class (W211)	2005 --> mi-2009	S122228002	<b>65646-67</b>	(6)	<b>65661-KU</b>	6	--	B
E-Class (W212)	07-2009 --> 12/2016	A0025409017/ A0035400217/ A0009054100	<b>65971-67</b> cerchi lega/Alu rims/ jantes alu <b>65970-67</b> cerchi ferro/steel rims/jantes tôle	(3)	<b>65962-KD</b> cerchi lega/jantes alu/Alu rims <b>65964-KD</b> cerchi ferro/jantes tôle/Steel rims	6	--	B
G-Class (463)	04/2007 --> 12/2016	A0025409017/ A0035400217/ A0009054100	<b>65971-67</b> cerchi lega/Alu rims/ jantes alu <b>65970-67</b> cerchi ferro/steel rims/jantes tôle	(3)	<b>65962-KD</b> cerchi lega/jantes alu/Alu rims <b>65964-KD</b> cerchi ferro/jantes tôle/Steel rims	6	--	B
GL-Class (X164)	06/2009 --> 12/2011	A0025409017/ A0035400217/ A0009054100	<b>65971-67</b> cerchi lega/Alu rims/ jantes alu <b>65970-67</b> cerchi ferro/steel rims/jantes tôle	(3)	<b>65962-KD</b> cerchi lega/jantes alu/Alu rims <b>65964-KD</b> cerchi ferro/jantes tôle/Steel rims	6	--	B

Veicolo Vehicle Vehicule	Data di produzione Manufacturing date Date de production	ID Sensore Sensor ID Capteur ID	Sensore completo Complete sensor Capteur complet	Tipo Type Type	Kit accessori Service Kit Accessoires reveente	Nm dado Nm nut Nm écrou	Nm vite Nm screw Nm vis	Nota Note Note
<b>MERCEDES</b>								
GLK-Class (X204)	01/2008 --> 12/2016	A0025409017/ A0035400217/ A0009054100	<b>65971-67</b> cerchi lega/Alu rims/ jantes alu <b>65970-67</b> cerchi ferro/steel rims/jantes tôle	(3)	<b>65962-KD</b> cerchi lega/jantes alu/Alu rims <b>65964-KD</b> cerchi ferro/jantes tôle/Steel rims	6	--	B
M-Class (W164)	07/2005 --> 05/2009	S122228002	<b>65646-67</b>	(6)	<b>65661-KU</b>	6	--	B
M-Class	06/2009 --> 12/2016	A0009054100	<b>65971-67</b> cerchi lega/Alu rims/ jantes alu <b>65970-67</b> cerchi ferro/steel rims/jantes tôle	(3)	<b>65962-KD</b> cerchi lega/jantes alu/Alu rims <b>65964-KD</b> cerchi ferro/jantes tôle/Steel rims	6	--	B
M-Class (W166)	06/2011 --> 12/2016	A0009054100	<b>65971-67</b> cerchi lega/Alu rims/ jantes alu <b>65970-67</b> cerchi ferro/steel rims/jantes tôle	(3)	<b>65962-KD</b> cerchi lega/jantes alu/Alu rims <b>65964-KD</b> cerchi ferro/jantes tôle/Steel rims	6	--	B
R-Class (W251)	01/2006 --> 05/2009	S122228002	<b>65646-67</b>	(6)	<b>65661-KU</b>	6	--	B
R-Class	06/2009 --> 12/2016	A0009054100	<b>65971-67</b> cerchi lega/Alu rims/ jantes alu <b>65970-67</b> cerchi ferro/steel rims/jantes tôle	(3)	<b>65962-KD</b> cerchi lega/jantes alu/Alu rims <b>65964-KD</b> cerchi ferro/jantes tôle/Steel rims	6	--	B
S-Class (W221)	10/2005 --> 05/2009	S122228002	<b>65646-67</b>	(6)	<b>65661-KU</b>	6	--	B
S-Class (W221)	06/2009 --> 12/2012	A0025409017/ A0035400217/ A0009054100	<b>65971-67</b> cerchi lega/Alu rims/ jantes alu <b>65970-67</b> cerchi ferro/steel rims/jantes tôle	(3)	<b>65962-KD</b> cerchi lega/jantes alu/Alu rims <b>65964-KD</b> cerchi ferro/jantes tôle/Steel rims	6	--	B
S-Class (W222)	01/2013 --> 12/2016	A0009054100	<b>65971-67</b> cerchi lega/Alu rims/ jantes alu <b>65970-67</b> cerchi ferro/steel rims/jantes tôle	(3)	<b>65962-KD</b> cerchi lega/jantes alu/Alu rims <b>65964-KD</b> cerchi ferro/jantes tôle/Steel rims	6	--	B
SL (W230)	06/2005 --> 12/2011	S122228002	<b>65646-67</b>	(6)	<b>65661-KU</b>	6	--	B
SL (W231)	01/2012 --> 12/2016	A0009054100	<b>65971-67</b> cerchi lega/Alu rims/ jantes alu <b>65970-67</b> cerchi ferro/steel rims/jantes tôle	(3)	<b>65962-KD</b> cerchi lega/jantes alu/Alu rims <b>65964-KD</b> cerchi ferro/jantes tôle/Steel rims	6	--	B
SLK (171/172)	04/2007 --> 12/2016	A0025409017/ A0035400217/ A0009054100	<b>65971-67</b> cerchi lega/Alu rims/ jantes alu <b>65970-67</b> cerchi ferro/steel rims/jantes tôle	(3)	<b>65962-KD</b> cerchi lega/jantes alu/Alu rims <b>65964-KD</b> cerchi ferro/jantes tôle/Steel rims	6	--	B
SLS (197)	01/2010 --> 12/2016	A0009054100	<b>65971-67</b> cerchi lega/Alu rims/ jantes alu <b>65970-67</b> cerchi ferro/steel rims/jantes tôle	(3)	<b>65962-KD</b> cerchi lega/jantes alu/Alu rims <b>65964-KD</b> cerchi ferro/jantes tôle/Steel rims	6	--	B
Smart (451)	04/2007 --> 12/2014	A0025409017 ou A0035400217 ou A0009054100	<b>65971-67</b> cerchi lega/Alu rims/ jantes alu <b>65970-67</b> cerchi ferro/steel rims/jantes tôle	(3)	<b>65962-KD</b> cerchi lega/jantes alu/Alu rims <b>65964-KD</b> cerchi ferro/jantes tôle/Steel rims	6	--	B
Sprinter NVC 3 (906)	06/2006 --> 10/2011	S122228004	<b>65740-67</b>	(6)	<b>65958-KU</b>	6	--	B
Sprinter	11/2011 --> 12/2016	A0025409017/ A0035400217/ A0009054100	<b>65971-67</b> cerchi lega/Alu rims/ jantes alu <b>65970-67</b> cerchi ferro/steel rims/jantes tôle	(3)	<b>65962-KD</b> cerchi lega/jantes alu/Alu rims <b>65964-KD</b> cerchi ferro/jantes tôle/Steel rims	6	--	B
Vito NVC 2 (639)	06/2006 -->	S122228004	<b>65740-67</b>	(6)	<b>65958-KU</b>	6	--	B
Viano	2011 -->	S122228004	<b>65740-67</b>	(6)	<b>65958-KU</b>	6	--	B

**VALVOLE ED ACCESSORI**  
**VALVES AND ACCESSORIES**  
**VALVES ET ACCESSOIRES**

Veicolo Vehicle Vehicule	Data di produzione Manufacturing date Date de production	ID Sensore Sensor ID Capteur ID	Sensore completo Complete sensor Capteur complet	Tipo Type Type	Kit accessori Service Kit Accessoires revente	Nm dado Nm nut Nm écrou	Nm vite Nm screw Nm vis	Nota Note Note
<b>NISSAN</b>								
GTR*	02/2009 -->	40700JY00B	<b>65938-67</b>	(6)	<b>65961-KD</b>	8	--	A
PRIMERA	01/2002 -->	40700AV600	<b>65191-67</b>	(1)	<b>65657-KD</b>	7,5	--	A
<b>OPEL / VAUXHALL</b>								
Ampera	07/2005 -->	13348393	<b>65889-67</b>	(1)	<b>65657-KD</b>	8	--	B
Antara	01/2008 -->	--	<b>65649-67</b>	(7)	cappelletto/cap/bouchon R 1424-3 interno/core/méca 37992-69 corpo/body/corps + vite/screw/vis 66118-67	--	1,4	A
Astra H	01/2004 --> 08/2009	13354312	<b>66157-67</b>	(1)	<b>65657-KD</b>	6	--	A
Astra J	07/2005 -->	1331134/ 13327259/ 13348393	<b>65889-67</b>	(1)	<b>65657-KD</b>	8	--	B
Insigna	10/2008 -->	1331134/ 13327259/ 13348393	<b>65889-67</b>	(1)	<b>65657-KD</b>	8	--	B
Signum	08/2002 --> 08/2009	--	<b>65335-67</b>	(1)	<b>65657-KD</b>	7,5	--	B
Vectra	08/2002 --> 08/2008	--	<b>65335-67</b>	(1)	<b>65657-KD</b>	7,5	--	B
Vectra Estate	--> 08/2009	--	<b>65335-67</b>	(1)	<b>65657-KD</b>	7,5	--	B
Zafira B	01/2004 -->	13354312	<b>66157-67</b>	(1)	<b>65657-KD</b>	6	--	A
Zafira C	09/2009 -->	1331134 ou 13327259 ou 13348393	<b>65889-67</b>	(1)	<b>65657-KD</b>	8	--	B
<b>PEUGEOT</b>								
1007 (KM)	2005 --> 12/2009	S120120001	<b>65396-67</b>	(4)	<b>65659-KD</b>	8	--	A
207	02/2006 -->	S120120001	<b>65396-67</b>	(4)	<b>65659-KD</b>	8	--	A
307	11/2003 --> 02/2007	S120120001	<b>65396-67</b>	(4)	<b>65659-KD</b>	8	--	A
307 restylée	03/2007 -->	9673860880	<b>65597-67</b>	(7)	cappelletto/cap/bouchon R 1424-3 interno/core/méca 37992-69 corpo/body/corps + vite/screw/vis 66118-68	--	1,4	A
308	09/2007 -->	9673860880	<b>65597-67</b>	(7)	cappelletto/cap/bouchon R 1424-3 interno/core/méca 37992-69 corpo/body/corps + vite/screw/vis 66118-68	--	1,4	A
308 SW	début 2008 -->	9673860880	<b>65597-67</b>	(7)	cappelletto/cap/bouchon R 1424-3 interno/core/méca 37992-69 corpo/body/corps + vite/screw/vis 66118-68	--	1,4	A
3008	06/2009 -->	9673860880	<b>65597-67</b>	(7)	cappelletto/cap/bouchon R 1424-3 interno/core/méca 37992-69 corpo/body/corps + vite/screw/vis 66118-68	--	1,4	A
407 & 407 SW	05/2004 --> 03/2011	S120120001	<b>65396-67</b>	(4)	<b>65659-KD</b>	8	--	A
407 coupé	09/2005 -->	S120120001	<b>65396-67</b>	(4)	<b>65659-KD</b>	8	--	A
508	04/2011 -->	S120120001	<b>65396-67</b>	(4)	<b>65659-KD</b>	8	--	A
5008	09/2009 -->	9673860880	<b>65597-67</b>	(7)	cappelletto/cap/bouchon R 1424-3 interno/core/méca 37992-69 corpo/body/corps + vite/screw/vis 66118-68	--	1,4	A
607	05/2000 --> 09/2004	--	<b>60311-67</b>	(1)	<b>65656-KD</b>	4,25	--	A
607 II	10/2004 --> 09/2010	S120120001	<b>65396-67</b>	(1)	<b>65659-KD</b>	8	--	A
807	06/2002 --> 09/2005	--	<b>60311-67</b>	(1)	<b>65656-KD</b>	4,25	--	A
807	10/2005 -->	S120120001	<b>65396-67</b>	(4)	<b>65659-KD</b>	8	--	A
RCZ	03/2010 -->	9673860880	<b>65597-67</b>	(7)	cappelletto/cap/bouchon R 1424-3 interno/core/méca 37992-69 corpo/body/corps + vite/screw/vis 66118-68	--	1,4	A
<b>RENAULT</b>								
Clio III	09/2005 -->	--	<b>65336-67</b>	(1)	<b>65655-KD</b>	7,5	--	A
Espace IV	09/2002 -->	--	<b>60234-67</b> cerchi lega/Alu rims/ jantes alu <b>42323-67</b> cerchi ferro/steel rims/jantes tôle	(1)	<b>65654-KD</b> cerchi lega/jantes alu/Alu rims <b>65655-KD</b> cerchi ferro/jantes tôle/Steel rims	alu4,25/ tole7,5	--	A
Koleos Laguna II	06/2008 --> 10/2002 --> 03/2005	40700JY00B --	<b>65938-67</b> <b>60234-67</b> cerchi lega/Alu rims/ jantes alu <b>42323-67</b> cerchi ferro/steel rims/jantes tôle	(1)	<b>65961-KD</b> <b>65654-KD</b> cerchi lega/jantes alu/Alu rims <b>65655-KD</b> cerchi ferro/jantes tôle/Steel rims	8 alu4,25/ tole7,5	--	A
Laguna II restylée	04/2005 --> 09/2007	--	<b>60234-67</b> cerchi lega/Alu rims/ jantes alu <b>42323-67</b> cerchi ferro/steel rims/jantes tôle	(1)	<b>65654-KD</b> cerchi lega/jantes alu/Alu rims <b>65655-KD</b> cerchi ferro/jantes tôle/Steel rims	alu4,25/ tole7,5	--	A

Veicolo Vehicle Vehicule	Data di produzione Manufacturing date Date de production	ID Sensore Sensor ID Capteur ID	Sensore completo Complete sensor Capteur complet	Tipo Type Type	Kit accessori Service Kit Accessoires revente	Nm dado Nm nut Nm écrou	Nm vite Nm screw Nm vis	Nota Note Note
<b>RENAULT</b>								
Laguna III	09/2007 -->	S180052004	<b>65939-67</b>	(5)	<b>65963-KU</b> Corpo/body/corps <b>43171-68</b>	8	--	B
Latitude	01/2011 -->	S180052004	<b>65939-67</b>	(5)	<b>65963-KU</b> Corpo/body/corps <b>43171-68</b>	8	--	B
Megane 1	01/2001 --> 10/2002	--	<b>60234-67</b> cerchi lega/Alu rims/ jantes alu <b>42323-67</b> cerchi ferro/steel rims/jantes tôle	(1)	<b>65654-KD</b> cerchi lega/jantes alu/Alu rims <b>65655-KD</b> cerchi ferro/jantes tôle/Steel rims	alu4,25/ tole7,5	--	A
Megane II	11/2002 --> 09/2008	S120123006	<b>65397-67</b>	(4)	<b>65658-KD</b>	8,5	--	A + C
Megane III	10/2008 -->	S180052004	<b>65939-67</b>	(5)	<b>65963-KU</b> Corpo/body/corps <b>43171-68</b>	8	--	B
Modus	12/2005 -->	--	<b>65336-67</b>	(1)	<b>65655-KD</b>	7,5	--	A
Scénic 1	01/2001 --> 05/2003	--	<b>60234-67</b> cerchi lega/Alu rims/ jantes alu <b>42323-67</b> cerchi ferro/steel rims/jantes tôle	(1)	<b>65654-KD</b> cerchi lega/jantes alu/Alu rims <b>65655-KD</b> cerchi ferro/jantes tôle/Steel rims	alu4,25/ tole7,5	--	A
Scénic RX4	01/2001 --> 05/2003	--	<b>60234-67</b> cerchi lega/Alu rims/ jantes alu <b>42323-67</b> cerchi ferro/steel rims/jantes tôle	(1)	<b>65654-KD</b> cerchi lega/jantes alu/Alu rims <b>65655-KD</b> cerchi ferro/jantes tôle/Steel rims	alu4,25/ tole7,5	--	A
Scénic II	06/2003 --> 12/2008	S120123006	<b>65397-67</b>	(4)	<b>65658-KD</b>	8,5	--	A + C
Scénic II restylé	2006 --> 12/2008	S120123006A	<b>65397-67</b>	(5)	<b>65658-KD</b>	8,5	--	A + C
Scénic III	01/2009 -->	S180052004	<b>65939-67</b>	(5)	<b>65963-KU</b> Corpo/body/corps <b>43171-68</b>	8	--	B
Vel Satis	02/2002 -->	--	<b>60234-67</b> cerchi lega/Alu rims/ jantes alu <b>42323-67</b> cerchi ferro/steel rims/jantes tôle	(1)	<b>65654-KD</b> cerchi lega/jantes alu/Alu rims <b>65655-KD</b> cerchi ferro/jantes tôle/Steel rims	alu4,25/ tole7,5	--	A
<b>SAAB</b>								
9.3	07/2002 --> 04/2005	--	<b>65335-67</b>	(1)	<b>65657-KD</b>	7,5	--	B
9.3	07/2002 --> 12/2008	--	<b>65335-67</b>	(1)	<b>65657-KD</b>	7,5	--	B
9.3	07/2007 -->	13227143/ 12825085	<b>65717-67</b>	(1)	<b>65657-KD</b>	7,5	--	B
9.4X	04/2011 -->	20922901	<b>66074-67</b>	(7)	cappelletto/cap/bouchon <b>R 1424-3</b> interno/core/méca <b>37992-69</b> corpo/body/corps + vite/screw/vis <b>66118-68</b>	--	1,4	A
9.5	07/2002 --> 12/2008	--	<b>65335-67</b>	(1)	<b>65657-KD</b>	7,5	--	B
9.5	07/2007 -->	13227143/ 12825085	<b>65717-67</b>	(1)	<b>65657-KD</b>	7,5	--	B
9.7X	2007 --> 2008	25774007	<b>66050-67</b>	(2)	--	8	--	A
<b>SMART</b>								
FortTwo	04/2007-->	--	<b>65971-67</b> cerchi lega/Alu rims/ jantes alu <b>65970-67</b> cerchi ferro/steel rims/jantes tôle	(3)	<b>65962-KD</b> cerchi lega/jantes alu/Alu rims <b>65964-KD</b> cerchi ferro/jantes tôle/Steel rims	6	--	B
<b>VOLKSWAGEN</b>								
New Beetle	2006 --> 07/2010	S122215002	<b>65644-67</b>	(4)	<b>65660-KD</b>	8	--	B
Passat	03/2005 --> 10/2010	S122215002	<b>65644-67</b>	(4)	<b>65660-KD</b>	8	--	B
Passat Syncro	03/2005 --> 10/2010	S122215002	<b>65644-67</b>	(4)	<b>65660-KD</b>	8	--	B
<b>VOLVO</b>								
C30	2007 -->	S180052020	<b>66042-67</b>	(5)	<b>66070-KU</b>	8	--	B
C70	2006 -->	S180052020	<b>66042-67</b>	(5)	<b>66070-KU</b>	8	--	B
S40	2004 -->	S180052020	<b>66042-67</b>	(5)	<b>66070-KU</b>	8	--	B
S60	03/2010 -->	S180052020	<b>66042-67</b>	(5)	<b>66070-KU</b>	8	--	B
S80	03/2006 -->	S180052020	<b>66042-67</b>	(5)	<b>66070-KU</b>	8	--	B
V50	2004 -->	S180052020	<b>66042-67</b>	(5)	<b>66070-KU</b>	8	--	B
V60	11/2010 -->	S180052020	<b>66042-67</b>	(5)	<b>66070-KU</b>	8	--	B
V70	mi-2006 --> 07/2007	30748354	<b>65716-67</b>	(1)	<b>65657-KD</b>	7,5	--	B
V70	03/2007 -->	S180052020	<b>66042-67</b>	(5)	<b>66070-KU</b>	8	--	B
XC60	05/2008 -->	S180052020	<b>66042-67</b>	(5)	<b>66070-KU</b>	8	--	B
XC70	mi-2006 --> 07/2007	30748354	<b>65716-67</b>	(1)	<b>65657-KD</b>	7,5	--	B
XC70	08/2007 -->	S180052020	<b>66042-67</b>	(5)	<b>66070-KU</b>	8	--	B
XC90	mi-2006 -->	30748354	<b>65716-67</b>	(1)	<b>65657-KD</b>	7,5	--	B

**KIT di ricambio originali Schrader per sensori TPMS**  
**Schrader original service kits for TPMS sensors**  
**Kits de rechange originale Schrader pour capteurs TPMS**

Codice Code Code	Descrizione Description Description	Applicazione Application Application	Confezione Box Conditionnement
66118-68	Kit manutenzione originale Schrader per TPMS <i>Schrader original service kit for TPMS</i> <i>Kit de rechange originale Schrader pèour capturs TPMS</i>	65597-67 (Rev 4) 65649-67 (Rev 4) 66074-67 (Rev 4) 66128-67 (Rev 4)	10
66150-68	Kit manutenzione originale Schrader per TPMS <i>Schrader original service kit for TPMS</i> <i>Kit de rechange originale Schrader pèour capturs TPMS</i>	65722-67 (Rev 5) 66073-67 (Rev 5) 66137-67 (Rev 5)	10
43148-67	Kit manutenzione originale Schrader per TPMS <i>Schrader original service kit for TPMS</i> <i>Kit de rechange originale Schrader pèour capturs TPMS</i>	65939-67 66040-67 66042-67	1
43211-68	Kit manutenzione originale Schrader per TPMS <i>Schrader original service kit for TPMS</i> <i>Kit de rechange originale Schrader pèour capturs TPMS</i>	66041-67 66043-67	10



- Per altri accessori di ricambio originali Schrader consultare la tabella di pagina 95. - For other spare parts Schrader original please look at table at page 95.  
 - Pour autres accessoires de réchange originale Schrader consulter le tableau à la page 95.

**KIT di ricambio compatibili a sensori Schrader e VDO**  
**Service kits compatible with TPMS Schrader and VDO sensors**  
**Kits de rechange compatibles avec capteurs TPMS Schrader et VDO**

Codice Code Code	Descrizione Description Description	Rif. kit originale Ref. original kit Réf. kit original	Confezione Box Conditionnement
3040033B	Kit manutenzione compatibile TPMS Schrader <i>Service Kit compatible with Schrader TPMS</i> <i>Kit entretien compatible avec TPMS Schrader</i>	65654-KD	10
3040033C	Kit manutenzione compatibile TPMS Schrader <i>Service Kit compatible with Schrader TPMS</i> <i>Kit entretien compatible avec TPMS Schrader</i>	65655-KD	10
3040033D	Kit manutenzione compatibile TPMS Schrader <i>Service Kit compatible with Schrader TPMS</i> <i>Kit entretien compatible avec TPMS Schrader</i>	65656-KD	10
3040033E	Kit manutenzione compatibile TPMS Schrader <i>Service Kit compatible with Schrader TPMS</i> <i>Kit entretien compatible avec TPMS Schrader</i>	65657-KD	10
3040033F	Kit manutenzione compatibile TPMS VDO <i>Service Kit compatible with TPMS VDO</i> <i>Kit entretien compatible avec TPMS VDO</i>	65658-KD	10
3040033G	Kit manutenzione compatibile TPMS VDO <i>Service Kit compatible with TPMS VDO</i> <i>Kit entretien compatible avec TPMS VDO</i>	65659-KD	10
3040033H	Kit manutenzione compatibile TPMS VDO <i>Service Kit compatible with TPMS VDO</i> <i>Kit entretien compatible avec TPMS VDO</i>	65660-KD	10
3040033J	Kit manutenzione compatibile TPMS VDO <i>Service Kit compatible with TPMS VDO</i> <i>Kit entretien compatible avec TPMS VDO</i>	65768-KU	1
3040033K	Kit manutenzione compatibile TPMS VDO <i>Service Kit compatible with TPMS VDO</i> <i>Kit entretien compatible avec TPMS VDO</i>	65958-KU	1
3040033L	Kit manutenzione compatibile TPMS Schrader <i>Service Kit compatible with Schrader TPMS</i> <i>Kit entretien compatible avec TPMS Schrader</i>	65961-KD	10
3040033M	Kit manutenzione compatibile TPMS Schrader <i>Service Kit compatible with Schrader TPMS</i> <i>Kit entretien compatible avec TPMS Schrader</i>	65962-KD	10
3040033N	Kit manutenzione compatibile TPMS VDO <i>Service Kit compatible with TPMS VDO</i> <i>Kit entretien compatible avec TPMS VDO</i>	65963-KU	1
3040033P	Kit manutenzione compatibile TPMS Schrader <i>Service Kit compatible with Schrader TPMS</i> <i>Kit entretien compatible avec TPMS Schrader</i>	65964-KD	10
3040033Q	Kit manutenzione compatibile TPMS Schrader <i>Service Kit compatible with Schrader TPMS</i> <i>Kit entretien compatible avec TPMS Schrader</i>	65567-68	1



**Attrezzi per montaggio e smontaggio valvole TPMS**  
**Tools for mounting / dismantling TPMS sensors**  
**Outils pour montage et démontage senseurs TPMS**

<b>Codice</b> <i>Code</i> <i>Code</i>	<b>Descrizione</b> <i>Description</i> <i>Description</i>	<b>Rif.</b> <i>Ref.</i> <i>Réf.</i>
<b>3040035B</b>	Avvitatore dinamometrico (1 a 5 Nm) contenente: 1 avvitatore di coppia, 1 bussola avvitamento (SW 11), 1 punta torx T20, utensile valvola a scatto, leva per regolare la coppia <i>Adjustable torque driver (1 to 5 Nm). Contents: 1 torque screwdriver, 1 drive sockets (SW 11), 1 bit torx T20, clamp-in valve tool, lever to adjust the torque</i> <i>Visseuse de couple réglable (de 1 à 5 Nm) contenant: 1 Visseuse de couple, 1 bague de vissage (SW 11), 1 pointe torx T20, outil valve à détente, levier pour régler le couple</i>	234546
<b>3040035D</b>	Avvitatore di coppia da 0 a 8 Nm contenente: 1 avvitatore, 1 bussola 1/4 (11mm), 1 bussola 1/4 (12mm) <i>Torque screwdriver 0 to 8 Nm. Contents: 1 screwdriver, 1 socket 1/4 (11mm), 1 socket 1/4 (12mm)</i> <i>Visseuse de couple de 0 a 8 Nm contenant: 1 visseuse, 1 bague 1/4 (11mm), 1 bague 1/4 (12mm)</i>	65278-67
<b>3040035F</b>	Utensile TX10 1.4 Nm. Pre-impostato per serrare le viti dado TX10 delle valvole a scatto. <i>TX10 torque tool 1.4 Nm. Pre set for tightening the TX10 nut screws of snap-in valves</i> <i>Outil TX10 1.4 Nm. Établi pour le serrage des vis écrou TX10 des valves à détente</i>	65785-67
<b>3040035H</b>	Bussola per nipple 1/4 per chiavi torsiometriche 65062-67 e 65278-67 <i>Socket for 1/4 nipple for torque wrenches 65062-67 and 65278-67</i> <i>Bague pour nipple 1/4 pour clefs torsiométriques 65062.67 et 65278-67</i>	65599-67
<b>3040035J</b>	Nipple 1/4 torx 10 per bussola 65599-67 <i>1/4 torx 10 nipple for socket 65599-67</i> <i>Nipple 1/4 torx 10 pour bague 65599-67</i>	65600-67
<b>3040035L</b>	Utensile per la rimozione delle rondelle in gomma <i>Tool to remove the rubber grommets</i> <i>Outil pour enlever les rondelles en caoutchouc</i>	65784-67
<b>3040184B</b>	Svita interni singolo dinamometrico (vettura) <i>Single dynamometrical unscrewder for inside parts (car)</i> <i>Disp. dynamométrique individuel pour dévisser les parties intérieures (voiture)</i>	65916-67
<b>3040039</b>	Cofanetto chiave dinamometrica da 0 a 10 N.m. comprendente: 1 chiave dinamometrica / 1 bussola 1/4 esagonale da 11 mm. / 1 bussola 1/4 esagonale da 12 mm. / 1 portabussola a manica per smontaggio. <i>Case of dynamometric wrench from 0 to 10 N.m. including: 1 dynamometric wrench / 1 hexagonal impact socket 1/4 of 11 mm. / 1 hexagonal impact socket 1/4 of 12 mm. / 1 impact socket holder with sleeve for disassembling.</i> <i>Coffret clé dynamométrique de 0 à 10 N.m. incluant: 1 clé dynamométrique / 1 douille 1/4 hexagonale de 11 mm. / 1 douille 1/4 hexagonale de 12 mm. / 1 Porte douille à manche pour démontage.</i>	65062-67



3040035B



3040035D



3040035F



3040035H



3040035J



3040035L



3040184B



3040039

**Armadietto per stoccaggio valvole TPMS**  
**Cabinet for TPMS sensors storage**  
**Armoire pour stockage senseurs TPMS**

<b>Codice</b> <i>Code</i> <i>Code</i>	<b>Descrizione</b> <i>Description</i> <i>Description</i>	<b>Rif.</b> <i>Ref.</i> <i>Réf.</i>
<b>3040039B</b>	Armadietto dedicato all'assistenza TPMS : sensori ed accessori sono stoccati in luogo pulito e sicuro. Armadietto grigio metallico a parete - 4 ripiani, sportello con chiave. Dimensioni: l. 67 x h. 78 x profondità 26 cm Peso vuoto: 27 kg (venduto vuoto) <i>Cabinet dedicated to TPMS servicing: sensors, accessories are stocked in a clean and secure place. Mural metallic grey cabinet - 4 tablets, door with key</i> <i>Dimensions: l. 67 x h. 78 x depth 26 cm</i> <i>Empty weight: 27 kg (sold empty)</i> <i>Armoire dédié à l'assistance TPMS: senseurs et accessoires sont stockés en endroit propre et sûr. Armoire gris métallique mural - 4 rayons, porte avec clef.</i> <i>Dimensions: l. 67 x h. 78 x profondeur 26 cm</i> <i>Poids vide: 27 kg (vendu vide)</i>	65770-67





# VALVOLE ED ACCESSORI VALVES AND ACCESSORIES VALVES ET ACCESSOIRES

## Sensori TPMS universali EZ-Sensor Schrader Schrader EZ-Sensor TPMS universal sensors Senseurs TPMS universels EZ-Sensor Schrader



Codice Code Code	Descrizione Description Description	Note Note Note
66730-67	EZ Sensor snap-in 433MHz EZ Sensor snap-in 433MHz EZ Sensor snap-in 433MHz	Completo e montato con valvola di gomma. Rispettare le indicazioni del produttore per il limite di velocità. Complete and mounted with rubber valve. Respect manufacturer recommendations for speed limit. Complet et monté avec valve en caoutchouc. Respecter les indications du producteur pour la limite de vitesse.
66741-67	EZ Sensor clamp-in 433 MHz EZ Sensor clamp-in 433 MHz EZ Sensor clamp-in 433 MHz	Montato con valvola di metallo. Non ci sono limitazioni di velocità. Mounted with metal valve. No speed limitations. Monté avec valve en métal. Pas de limite de vitesse.
66742-68	Valvola snap-in di ricambio Spare snap-in valve Valve snap-in de rechange	Ricambio per 66730-67. Confezione da 10 pezzi. Spare for 66730-67. Box of 10 pcs. Rechange pour 66730-67. Conditionnement à 10 pcs.
66743-68	Valvola di metallo clamp-in di ricambio Spare metal clamp-in valve Valve en métal clamp-in de rechange	Ricambio per 66741-67. Confezione da 10 pezzi. Spare for 66741-67. Box of 10 pcs. Rechange pour 66741-67. Conditionnement à 10 pcs.
66744-KD	Service kit per valvola clamp-in Clamp-in valve service kit Kit service pour valve clamp-in	Ricambio per 66741-67. Contiene: interno, cappelletto, guarnizione. Confezione da 10 pezzi. Spare for 66741-67. It contains: core, cap, washer nut. Box of 10 pcs. Rechange pour 66741-67. Il contient: mécanisme, bouchon, joint.
66731-67	PAD per riprogrammazione EZ Sensor PAD for EZ Sensor reprogramming PAD pour reprogrammation EZ Sensor	Per programmazione (clonazione) del EZ Sensor. In alternativa a Exp'Air. For programming (cloning) EZ Sensor. As alternative to Exp'Air. Pour programmation (clonage) EZ Sensor. En alternative à Exp'Air.
66745-67	EZ Sensor Starter kit 433MHz EZ Sensor Starter kit 433MHz EZ Sensor Starter kit 433MHz	Contiene: 4 EZ Sensor clamp-in completi, 1 TPMS Pad, 1 cavo USB It contains: 4 EZ Sensor clamp-in complete, 1 TPMS Pad, 1 USB cable Il contient: 4 EZ Sensor clamp-in complets, 1 TPMS Pad, 1 cable USB
66691-67	Kit attrezzi montaggio EZ Sensor Case Kit to mount EZ Sensor Kit outils de montage EZ Sensor	Per montaggio/smontaggio EZ Sensor For mounting/demounting EZ Sensor Pour monter/démonter EZ Sensor
66032-67	EXP'AIR tool EXP'AIR tool EXP'AIR tool	Per diagnostica TPMS e programmazione (clonazione) EZ Sensor. To execute TPMS diagnostic and programming (cloning) EZ Sensor. Pour diagnostic TPMS et programmation (clonage) EZ Sensor.
66677-67	EXP'AIR aggiornamento internet per anno EXP'AIR internet update per year EXP'AIR ajournement internet annuel	Per diagnostica TPMS e programmazione (clonazione) EZ Sensor. To execute TPMS diagnostic and programming (cloning) EZ Sensor. Pour diagnostic TPMS et programmation (clonage) EZ Sensor.
66680-67	EXP'AIR aggiornamento SD card EXP'AIR SD card update EXP'AIR ajournement card SD	SD card per aggiornamento annuale Exp'Air SD card for yearly update of Exp'Air Card SD pour ajournement annuel Exp'Air

**Strumenti di riprogrammazione valvole TPMS e diagnostica base**  
**Tools for TPMS sensors reprogramming and basic diagnostic**  
**Outils de ré-programmation senseurs TPMS et diagnose base**

Codice Code Code	Descrizione Description Description	Rif. Ref. Réf.
3040039C	<p>Kit Activ'Air TPMS. Attivazione dei sensori durante la riprogrammazione</p> <ul style="list-style-type: none"> <li>- decodifica e visualizza i dati del sensore inclusi; sensore ID, pressione, temperatura</li> <li>- se viene trovato un sensore difettoso, marca-modello-anno fanno visualizzare i numeri del kit di servizio e del pezzo di ricambio Schrader</li> <li>- controllo stato batteria (quando questa informazione è disponibile nel sensore, l'utensile visualizza "OK" o "NON OK").</li> </ul> <p><i>Kit Activ'AirTPMS. Activation of sensors during reprogramming,</i></p> <ul style="list-style-type: none"> <li>- decodes and displays sensor data including: sensor ID, pressure, temperature,</li> <li>- if a faulty sensor is detected the make-model-year look up displays the Schrader replacement part and service kit numbers,</li> <li>- Control of battery status (when this information is available in the sensor, the tool displays "OK" or "NOT OK").</li> </ul> <p><i>Kit Activ'Air TPMS. Activation des senseurs pendant la ré-programmation.</i></p> <ul style="list-style-type: none"> <li>- décode et visualise les données du senseur incluant : senseur ID, pression, température</li> <li>- si on trouve un senseur défectueux, marque-modèle-an font visualiser les numéros de kit assistance et pièce de rechange Schrader</li> <li>- contrôle de l'état de la batterie (quand ce renseignement est disponible dans le senseur, l'outil visualise "OK" ou "NOT OK").</li> </ul>	65997-67
3040039D	<p>Utensile diagnosi multifunzione EuroDiag - Permette il dialogo con il sistema elettronico di 63 produttori di veicoli - Di facile utilizzo - La banca dati TPMS più completa sul mercato (Schrader, Conti-VDO, Beru...) - Aggiornamenti software disponibili, su internet o scheda SD</p> <p>- Capacità di stampare Reports Diagnosi. La valigetta contiene: 1 visualizzatore, 1 cavo EOBD, 1 lettore scheda SD, 1 cavo USB, 1 caricatore 230V, 1 custodia nera robusta 300x270x115mm, 1 custodia protettiva utensile. Peso visualizzatore: 500gr. Dimensioni utensile H. 200 x L. 120 x spessore 35mm.</p> <p><i>Multifunction diagnostic tool EuroDiag - Allows dialog with the electronic system of 63 vehicle manufacturers - Easy to use - The most complete TPMS data bank on the market (Schrader, Conti-VDO, Beru...) - Software updates available, either by internet or SD Card - Capability to print Diagnostic Reports</i></p> <p><i>Case contents: 1 display unit, 1 EOBD cable, 1 SD card reader, 1 USB cable, 1 charger 230V, 1 solid black case 300x270x115mm, 1 tool protective case.</i></p> <p><i>Display unit weight: 500gr. Tool dimensions H. 200x L. 120 x th. 35mm.</i></p> <p><i>Outil diagnose multifonctionnel EuroDiag - Il permet le dialogue avec le système électronique de 63 producteurs de véhicules - Emploi facile - La banque données TPMS la plus complète dans le marché (Schrader, Conti-VDO, Beru...) - Ajournements software disponibles, sur internet ou fiche SD - Capacité d'imprimer les Rapports Diagnose. La mallette contient : 1 visualiseur, 1 câble EOBD, 1 lecteur fiche SD, 1 câble USB, 1 chargeur 230V, 1 étui noir robuste 300x270x115mm, 1 étui de protection outil.</i></p> <p><i>Poids visualiseur: 500gr. Dimensions outil H. 200 x L. 120 x épaisseur 35mm.</i></p>	65772-67



3040039C



3040039D

**Kit TPMS per after market - universale**  
**TPMS kit for after market - universal**  
**Kit TPMS pour after market - universel**

Codice Code Code	Descrizione Description Description	Composizione Composition Composition
3040039E	<p>KIT TPMS collegabile all'accendisigari dell'auto</p> <p>8,27bar/120PSi</p> <p><i>TPMS KIT that can be connected to the car lighter</i></p> <p>8,27bar/120PSi</p> <p><i>KIT TPMS qui peut être branché au briquet de la voiture</i></p> <p>8,27bar/120PSi</p>	<p>4 cappelletti programmabili</p> <p>1 monitor digitale</p> <p>4 programmable caps</p> <p>1 digital monitor</p> <p>4 bouchons programmables</p> <p>1 monitor digital</p>



**CARATTERISTICHE**

- Indica la pressione di ogni pneumatico;
- LED Multicolore (blu, verde, giallo, rosso) per segnalare la pressione;
- Allarme acustico;
- Batterie ricaricabili;
- Semplicità di installazione;
- Display facilmente visibile;
- Universale per tutti i tipi di veicoli (con accendisigari).

**FEATURES**

- It indicates pressure of every tyre;
- Multicolour LED (blue, green, yellow, red) to indicate pressure;
- Acoustic alarm;
- Rechargeable batteries;
- Easy installation;
- Easily visible display;
- Universal for all models of vehicles (with lighter).



**CARACTÉRISTIQUES**

- Il indique la pression de chaque pneu;
- LED Multi-couleur (bleu, vert, jaune, rouge) pour indiquer la pression;
- Alarme acoustique;
- Batteries rechargeables;
- Installation facile;
- Display facilement visible;
- Universel pour tous modèles de véhicules (avec briquet).



NOTA / NOTE / NOTE: Si raccomanda di usare i cappelletti programmabili su valvole in metallo.  
*The application of the programmable caps on metal valves is recommended.*  
*Il est recommandé d'utiliser les bouchons programmables sur les valves en métal.*







**Valvole tubeless autocarro in ottone dritte**  
**Straight brass tubeless valves for truck**  
**Valves tubeless droites en laiton pour camion**

Codice Code Code	Descrizione Description Description	Rif. Ref. Réf.	Lungh. mm Length in mm Longueur en mm	Foro Hole Forure	Applicazione Application Application
3040040	Valvola tubeless autocarro Truck tubeless valve Valve tubeless camion	V3-20-1	36	9,7	
3040040B	Valvola tubeless autocarro lunga Long truck tubeless valve Valve tubeless camion longue	V3-20-3	82	9,7	



3040040

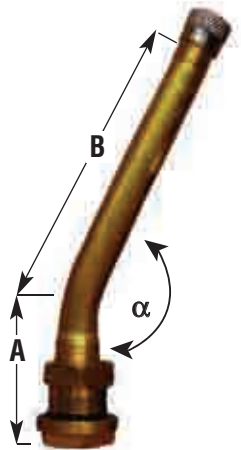

**Valvole tubeless autocarro in ottone con una curva**  
**Brass tubeless truck valves with one curve**  
**Valves tubeless camion en laiton avec une courbe**

Codice Code Code	Descrizione Description Description	Rif. Ref. Réf.	Mis. A mm Size A mm Dimension A mm	Mis. B mm Size B mm Dimension B mm	$\alpha$ $\alpha$ $\alpha$	Applicazione Application Application
3040041	Valvola tubeless autocarro Truck tubeless valve Valve tubeless camion	V3-20-5	25	40	27°	
3040042	Valvola tubeless autocarro Truck tubeless valve Valve tubeless camion	V3-20-7	25	50	27°	
3040043	Valvola tubeless autocarro Truck tubeless valve Valve tubeless camion	V3-20-4	25	60	27°	
3040044	Valvola tubeless autocarro Truck tubeless valve Valve tubeless camion	V3-20-6	25	85	27°	
3040046	Valvola tubeless autocarro Truck tubeless valve Valve tubeless camion	V0-07-3	30	95	27°	
3040047	Valvola tubeless autocarro Truck tubeless valve	V3-20-10	50	25	27°	



3040043

**Valvole tubeless autocarro in ottone con due curve**  
**Brass tubeless truck valves with two curves**  
**Valves tubeless camion en laiton avec deux courbes**

Codice Code Code	Descrizione Description Description	Rif. Ref. Réf.	Mis. A mm Size A mm Dim. A mm	Mis. B mm Size B mm Dim. B mm	Mis. C mm Size C mm Dim. C mm	Applicazione Application Application
3040047A	Valvola tubeless autocarro Truck tubeless valve Valve tubeless camion	-	41	22	65	
3040049	Valvola tubeless autocarro Truck tubeless valve Valve tubeless camion	V3-20-11	25	45	25	

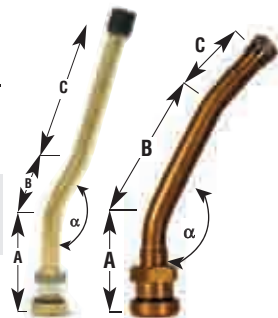

3040047A 3040049

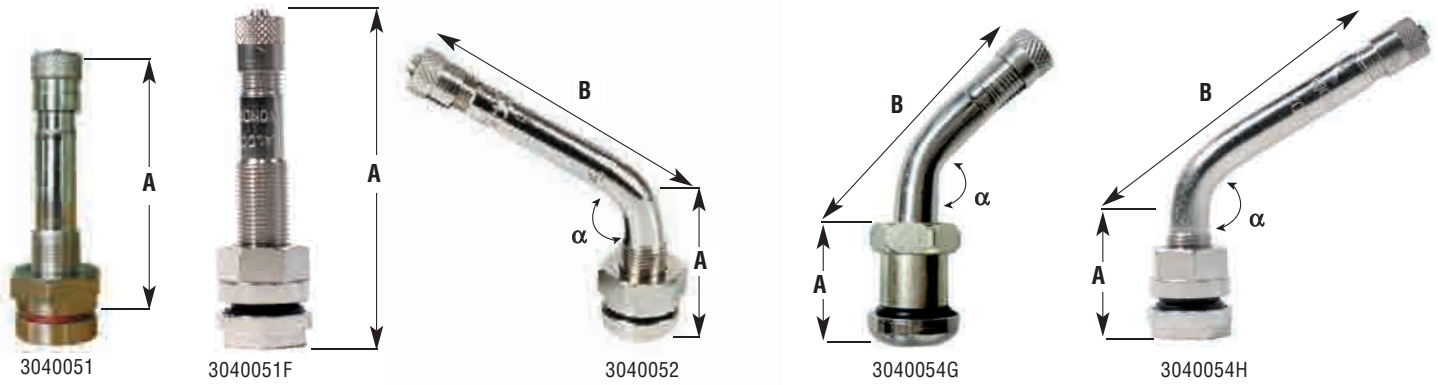

**Valvole tubeless autocarro nichelate per cerchi in lega**  
**Tubeless nickel-plated valves for truck alloy rims**  
**Valves tubeless nickelées pour jantes camion en alliage**

Codice Code Code	Descrizione Description Description	Rif. Ref. Réf.	Mis. A mm Size A mm Dimension A mm	Mis. B mm Size B mm Dimension B mm	$\alpha$ $\alpha$ $\alpha$	Applicazione Application Application
3040051	Valv. tubeless autocarro nichelata Truck tubeless nickel-plated valve Valve tubeless nickelée camion	TR 542	32	–	–	
3040051B	Valv. tubeless autocarro nichelata Truck tubeless nickel-plated valve Valve tubeless nickelée camion	TR 543	59	–	–	
3040051C	Valv. tubeless autocarro nichelata Truck tubeless nickel-plated valve Valve tubeless nickelée camion	TR 544	73	–	–	
3040051D	Valv. tubeless autocarro nichelata Truck tubeless nickel-plated valve Valve tubeless nickelée camion	TR 545	89	–	–	
3040051E	Valv. tubeless autocarro nichelata Truck tubeless nickel-plated valve Valve tubeless nickelée camion	TR 546	108	–	–	
3040051F	Valv. tubeless autocarro nichelata Truck tubeless nickel-plated valve Valve tubeless nickelée camion	–	53,5	–	–	
3040052	Valv. tubeless autocarro nichelata Truck tubeless nickel-plated valve Valve tubeless nickelée camion	TR 543C	23,5	35	45°	
3040053	Valv. tubeless autocarro nichelata Truck tubeless nickel-plated valve Valve tubeless nickelée camion	TR 543D	25	35	60°	
3040053A	Valv. tubeless autocarro nichelata Truck tubeless nickel-plated valve Valve tubeless nickelée camion	TR 543E	25	35	75°	
3040054	Valv. tubeless autocarro nichelata Truck tubeless nickel-plated valve Valve tubeless nickelée camion	TR 544D	25	49	60°	
3040054D	Valv. tubeless autocarro nichelata Truck tubeless nickel-plated valve Valve tubeless nickelée camion	TR 545D	25	66	60°	
3040054E	Valv. tubeless autocarro nichelata Truck tubeless nickel-plated valve Valve tubeless nickelée camion	TR 546D	25	85	60°	
3040054F	Valv. tubeless autocarro nichelata Truck tubeless nickel-plated valve Valve tubeless nickelée camion	TR 546E	25	85	75°	
3040054G	Valv. tubeless autocarro nichelata Truck tubeless nickel-plated valve Valve tubeless nickelée camion	V3-22-1	25	28	45°	
3040054H	Valv. tubeless autocarro nichelata Truck tubeless nickel-plated valve Valve tubeless nickelée camion	TR 544D	30	54	60°	

**VALVOLE ED ACCESSORI**  
**VALVES AND ACCESSORIES**  
**VALVES ET ACCESSOIRES**



**Valvole tubeless autocarro**  
**Tubeless valves for truck**  
**Valves tubeless pour camion**

Codice Code Code	Descrizione Description Description	Rif. Ref. Réf.	Mis. A mm Size A mm Dimension A mm	Mis. B mm Size B mm Dimension B mm	α α α	Applicazione Application Application
3040055A	Valvola tubeless autocarro Truck tubeless valve Valve tubeless camion	V3-21-1	29	–	–	
3040055C	Valvola tubeless autocarro Truck tubeless valve Valve tubeless camion	V3-21-2	38	–	–	
3040055E	Valvola tubeless autocarro Truck tubeless valve Valve tubeless camion	V3-21-3	51	–	–	
3040055G	Valvola tubeless autocarro Truck tubeless valve Valve tubeless camion	V3-21-4	79	–	–	
3040055L	Valvola tubeless autocarro Truck tubeless valve Valve tubeless camion	V3-21-5	86	–	–	
3040055N	Valvola tubeless autocarro Truck tubeless valve Valve tubeless camion	V3-21-6	95	–	–	
3040055P	Valvola tubeless autocarro Truck tubeless valve Valve tubeless camion	V3-21-7	111	–	–	
3040055Q	Valvola tubeless autocarro Truck tubeless valve Valve tubeless camion	V3-21-8	127	–	–	
3040055R	Valvola tubeless autocarro Truck tubeless valve Valve tubeless camion	V3-21-9	33	51	90°	
3040055S	Valvola tubeless autocarro Truck tubeless valve Valve tubeless camion	V3-21-10	33	58	90°	
3040055T	Valvola tubeless autocarro Truck tubeless valve Valve tubeless camion	V3-21-11	33	67	90°	
3040055V	Valvola tubeless autocarro Truck tubeless valve	V3-21-12	33	83	90°	

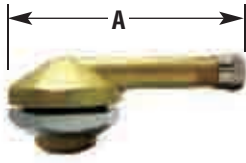

3040056

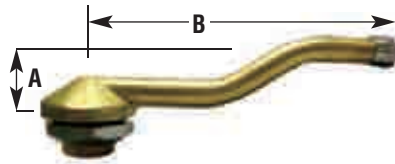

3040058

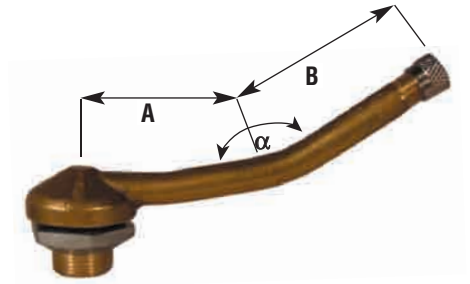

3040060

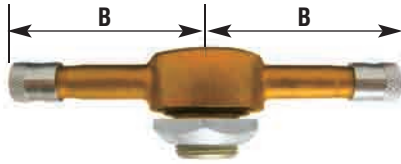

3040064

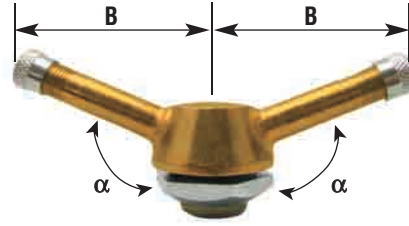

3040065

**Valvole tubeless autocarro**  
**Tubeless valves for truck**  
**Valves tubeless pour camion**

<b>Codice</b> Code Code	<b>Descrizione</b> Description Description	<b>Rif.</b> Ref. Réf.	<b>Mis. A mm</b> Size A mm Dimension A mm	<b>Mis. B mm</b> Size B mm Dimension B mm	<b>α</b> α α	<b>Applicazione</b> Application Application
3040056	Valvola tubeless autocarro Truck tubeless valve Valve tubeless camion	V3-12-1	40	–	–	
3040056A	Valvola tubeless autocarro Truck tubeless valve Valve tubeless camion	V3-12-2	95	–	–	
3040057	Valvola tubeless autocarro Truck tubeless valve Valve tubeless camion	V3-13-1	27	42,5	153°	
3040058	Valvola tubeless autocarro Truck tubeless valve Valve tubeless camion	V3-14-1	14	72	–	
3040059	Valvola tubeless autocarro Truck tubeless valve Valve tubeless camion	V3-14-2	14	91	–	
3040059A	Valvola tubeless autocarro Truck tubeless valve Valve tubeless camion	V3-14-3	121	83	–	
3040060	Valvola tubeless autocarro Truck tubeless valve Valve tubeless camion	V3-13-2	10,5	79	126°	
3040061	Valvola tubeless autocarro Truck tubeless valve Valve tubeless camion	V3-16-1	36	29	150°	
3040064	Valvola tubeless autocarro Truck tubeless valve Valve tubeless camion	1550	–	45	–	
3040065	Valvola tubeless autocarro Truck tubeless valve Valve tubeless camion	1581	–	30	45°	

# VALVOLE ED ACCESSORI









## VALVES AND ACCESSORIES

### VALVES ET ACCESSOIRES





#### Valvole avvitabili autocarro per camera d'aria

#### Truck valves to be screwed for tube tyres

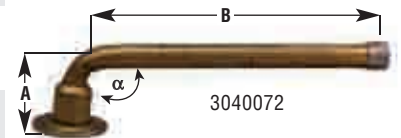



#### Valves camion à visser pour chambres à air pneu

Codice Code Code	Descrizione Description Description	Rif. Ref. Réf.	Mis. A Size A Dimension A	Mis. B Size B Dimension B	$\alpha$ $\alpha$ $\alpha$	Applicazione Application Application
3040070	Valv. avvitabile autocarro ad 1 curva 1 curve truck valve to be screwed Valve camion à visser à 1 courbe	V3-02-3	33	44,5	95°	
3040071	Valv. avvitabile autocarro ad 1 curva 1 curve truck valve to be screwed Valve camion à visser à 1 courbe	V3-02-7	22,5	71,5	100°	
3040071A	Valv. avvitabile autocarro ad 1 curva 1 curve truck valve to be screwed Valve camion à visser à 1 courbe	V3-02-8	20,5	89,5	94°	
3040072	Valv. avvitabile autocarro ad 1 curva 1 curve truck valve to be screwed Valve camion à visser à 1 courbe	V3-02-9	20,5	99,5	94°	
3040073	Valv. avvitabile autocarro ad 1 curva 1 curve truck valve to be screwed Valve camion à visser à 1 courbe	V3-02-16	20,5	149,5	90°	
3040073A	Valv. avvitabile autocarro ad 1 curva 1 curve truck valve to be screwed Valve camion à visser à 1 courbe	V3-02-17	20,5	156,5	90°	
3040073B	Valv. avvitabile autocarro ad 1 curva 1 curve truck valve to be screwed Valve camion à visser à 1 courbe	V3-02-19	20,5	60	94°	
3040074	Valv. avvitabile autocarro ad 1 curva 1 curve truck valve to be screwed Valve camion à visser à 1 courbe	V3-02-21	23,5	172	90°	

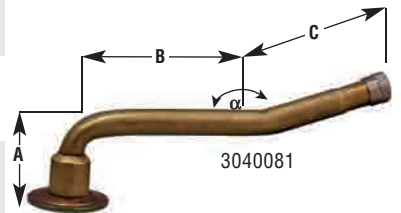



Codice Code Code	Descrizione Description Description	Rif. Ref. Réf.	Mis. A Size A Dim. A	Mis. B Size B Dim. B	Mis. C Size C Dim. C	$\alpha$ $\alpha$ $\alpha$	Applicazione Application Application
3040079	Valv. avvitabile autocarro a 2 curve 2 curves truck valve to be screwed Valve camion à visser à 2 courbes	V3-04-1	20,5	32	37	90°	
3040080	Valv. avvitabile autocarro a 2 curve 2 curves truck valve to be screwed Valve camion à visser à 2 courbes	V3-04-2	20,5	38	41,5	153°	
3040081	Valv. avvitabile autocarro a 2 curve 2 curves truck valve to be screwed Valve camion à visser à 2 courbes	V3-04-3	20	59	38,5	163°	
3040082	Valv. avvitabile autocarro a 2 curve 2 curves truck valve to be screwed Valve camion à visser à 2 courbes	V3-04-4	20	74	40	144°	
3040084	Valv. avvitabile autocarro a 2 curve 2 curves truck valve to be screwed Valve camion à visser à 2 courbes	V3-04-6	20	86	47,5	153°	

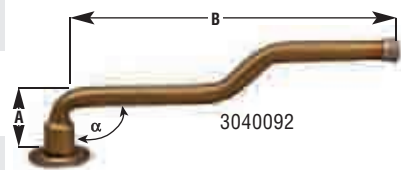

Codice Code Code	Descrizione Description Description	Rif. Ref. Réf.	Mis. A Size A Dimension A	Mis. B Size B Dimension B	$\alpha$ $\alpha$ $\alpha$	Applicazione Application Application
3040090	Valv. avvitabile autocarro a 3 curve 3 curves truck valve to be screwed Valve camion à visser à 3 courbes	V3-06-2	23,5	94	90°	
3040091	Valv. avvitabile autocarro a 3 curve 3 curves truck valve to be screwed Valve camion à visser à 3 courbes	V3-06-3	23,5	114	90°	
3040092	Valv. avvitabile autocarro a 3 curve 3 curves truck valve to be screwed Valve camion à visser à 3 courbes	V3-06-5	23,5	131	90°	
3040093	Valv. avvitabile autocarro a 3 curve 3 curves truck valve to be screwed Valve camion à visser à 3 courbes	V3-06-6	23	137	90°	
3040093B	Valv. avvitabile autocarro a 3 curve 3 curves truck valve to be screwed Valve camion à visser à 3 courbes	V3-06-8	24,5	112	90°	





**Accessori per valvole avvitabili**  
**Accessories for valves to be screwed - Accessoires pour valves à visser**

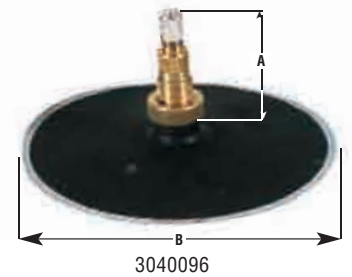

Codice Code Code	Descrizione Description Description	Rif. Ref. Réf.	Mis. A Size A Dimen. A	Mis. B Size B Dimen. B	Applicazione Application Application
3040094	Rondella di tenuta per valvole avvitabili (100 pz.) Sealing washer for valves to be screwed (100 pcs.) Rondelle d'étanchéité pour valves à visser (100 pcs.)	V9-05-1	8,5	25	
3040095	Base per valvola avv. autovulcanizzante a freddo Cold self-curing base for valve to be screwed Base autovulcanisante à froid pour valve à visser	V3-08-3	10	82	
3040096	Valvola con base autovulcanizzante a freddo Valve with cold self-curing base Valve avec base autovulcanisante à froid	TR218A	50	110	





**Valvole trattore**  
**Tractor valves - Valves pour tracteur**

Codice Code Code	Descrizione Description Description	Rif. Ref. Réf.	Mis. A Size A Dimen. A	Mis. B Size B Dimen. B	Applicazione Application Application
3040100	Valvola per camere d'aria trattore (651) Tractor air tubes valve (651) Valve pour chambres à air tracteur (651)	TR218	31,8	51	

Codice Code Code	Descrizione Description Description	Rif. Ref. Réf.	Mis. A Size A Dimen. A	Mis. B Size B Dimen. B	Applicazione Application Application
3040101	Valvola tubeless trattore Tractor tubeless valve Valve tubeless tracteur	TR618A	22,5	43,5	
3040101A	Valvola tubeless trattore Snap-in Snap-in tractor tubeless valve Valve tubeless tracteur Snap-in	-	22,5	60	

Codice Code Code	Descrizione Description Description	Rif. Ref. Réf.	Mis. A Size A Dimen. A	Mis. B Size B Dimen. B	$\alpha$ $\alpha$ $\alpha$	Applicazione Application Application
3040102	Valvola tubeless trattore Tractor tubeless valve Valve tubeless tracteur	TR621A	39	54,5	115°	
3040103	Valvola tubeless trattore Tractor tubeless valve Valve tubeless tracteur	TR622A	44,5	94,5	90°	
3040104	Valvola tubeless trattore Tractor tubeless valve Valve tubeless tracteur	TR623A	39	36,5	115°	

Codice Code Code	Descrizione Description Description	Rif. Ref. Réf.	Rif. TR TR Ref. Réf. TR	Applicazione Application Application
3040105	Interno valvola trattore (tipo vecchio) Inside part of tractor valve (old model) Partie intérieure valve tracteur (vieux modèle)	587	CH-1	
3040106	Interno valvola trattore (tipo nuovo) Inside part of tractor valve (new model) Partie intérieure valve tracteur (nouveau modèle)	1139	CH-3	
3040106C	Interno valvola trattore (tipo nuovo) - corto Inside part of tractor valve (new model) - short Partie intérieure valve tracteur (nouveau modèle) - court	--	CH-3	





**Valvole tubeless Genio Civile**  
**E.M. tubeless valves - Valves tubeless Génie Civil**

Codice Code Code	Descrizione Description Description	Rif. Ref. Réf.	Mis. A Size A Dim.A	Mis. B Size B Dim.B	$\alpha$ $\alpha$ $\alpha$	Applicazione Application Application
3040115	Valvola tubeless Genio Civile E.M. tubeless valve Valve tubeless Génie Civil	TRJ650	27	80	80°	
3040115A	Valvola tubeless Genio Civile E.M. tubeless valve Valve tubeless Génie Civil	TRJ651	32	119	90°	
3040115B	Valvola tubeless Genio Civile E.M. tubeless valve Valve tubeless Génie Civil	TRJ652	27	140	86°	
3040115C	Valvola tubeless Genio Civile E.M. tubeless valve Valve tubeless Génie Civil	TRJ653	27	64	80°	
3040116	Valvola tubeless Genio Civile E.M. tubeless valve Valve tubeless Génie Civil	TRJ657	27	102	80°	
3040116A	Valvola tubeless Genio Civile E.M. tubeless valve Valve tubeless Génie Civil	V5-07-01	27	50	92°	
3040116C	Valvola tubeless Genio Civile E.M. tubeless valve Valve tubeless Génie Civil	V5-07-04	27	75	92°	
3040116E	Valvola tubeless Genio Civile E.M. tubeless valve Valve tubeless Génie Civil	V5-07-06	27	100	92°	
3040116G	Valvola tubeless Genio Civile E.M. tubeless valve Valve tubeless Génie Civil	V5-07-02	32	50	100°	
3040116K	Valvola tubeless Genio Civile E.M. tubeless valve Valve tubeless Génie Civil	V5-07-05	25	90	90°	
3040117	Valvola tubeless Genio Civile E.M. tubeless valve Valve tubeless Génie Civil	TRJ670	41	-	-	
3040118	Valvola tubeless Genio Civile E.M. tubeless valve Valve tubeless Génie Civil	V5-06-01	41	-	-	

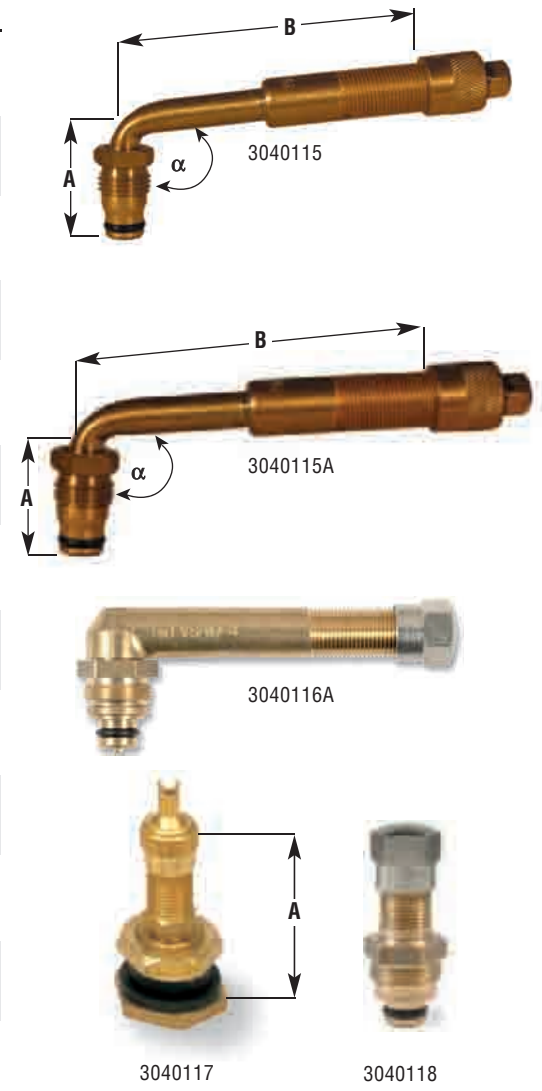

Codice Code Code	Descrizione Description Description	Rif. Ref. Réf.	Applicazione Application Application
3040120	Base per valvola Genio Civile Base for E.M. valve Base pour valve Génie Civil	SP2	
3040120B	Base per valvola Genio Civile - filetto corto (16 mm) Base for E.M. valve - short thread (16 mm) Base pour valve Génie Civil - Filet court (16mm)	V5-12-2	
3040120C	Base per valvola Genio Civile - filetto lungo (21,5 mm) Base for E.M. valve - long thread (21,5 mm) Base pour valve Génie Civil - filet long (21,5 mm)	V5-12-1	
3040121	Riduzione per valvola Genio Civile Reduction for E.M. valve Réduction pour valve Génie Civil	697	
3040122	Interno valvola G.C. lungo in ottone - guarnizione Teflon nera Long brass inside part - E.M. valve - black Teflon seal Partie intérieure laiton longue - valve G.C. - joint Teflon noir	7316	
3040122B	Interno valvola G.C. lungo nichelato con guarnizione in Teflon rossa Long nickel plated inside part - E.M. valve - red Teflon seal Partie intérieure nickelée longue - valve G.C. - joint Teflon rouge	-	
3040123	Interno valvola G.C. corto in ottone - guarnizione Teflon rossa Short brass inside part - E.M. valve - red Teflon seal Partie intérieure laiton courte - valve G.C. - joint Teflon rouge	-	
3040123B	Interno valvola G.C. corto nichelato con guarnizione in Teflon rossa Short nickel plated inside part - E.M. valve - red Teflon seal Partie intérieure nickelée courte - valve G.C. - joint Teflon rouge	-	



**Accessori per valvole e prolungh**  
**Accessories for valves and extensions - Accessoires pour valves et rallonges**

<b>Codice</b> <i>Code</i> <i>Code</i>	<b>Descrizione</b> <i>Description</i> <i>Description</i>	<b>Rif.</b> <i>Ref.</i> <i>Réf.</i>	<b>Confezione</b> <i>Box</i> <i>Conditionnement</i>
<b>3040126</b>	Interno valvola corto in ottone con guarnizione in Teflon nero. <i>Short valve core brass finish with black Teflon seal.</i> <i>Partie intérieure courte pour valve en laiton avec joint Teflon noir.</i>	1320 S	100
<b>3040126A</b>	Interno valvola corto in ottone con guarnizione in Teflon rossa per alte temperature. <i>Short valve core brass finish with red Teflon seal for high temperatures.</i> <i>Partie intérieure courte pour valve en laiton avec joint Teflon rouge pour hautes températures.</i>	1320 S	100
<b>3040126B</b>	Interno valvola corto nichelato con guarnizione in Teflon rossa per alte temperature (raccomandato per TPMS). <i>Short valve core nickel plated with red Teflon seal for high temperatures (recommended for TPMS).</i> <i>Partie intérieure courte nickelée avec joint rouge Teflon pour hautes températures (recommandé pour TPMS).</i>	-	100
<b>3040127</b>	Interno valvola lunga in ottone con guarnizione in Teflon nero. <i>Long valve core brass finish with black Teflon seal.</i> <i>Partie intérieure longue pour valve en laiton avec joint noir Teflon.</i>	1302	100
<b>3040127A</b>	Interno valvola lunga in ottone con guarnizione in Teflon rossa per alte temperature. <i>Long valve core brass finish with red Teflon seal for high temperatures.</i> <i>Partie intérieure longue pour valve en laiton avec joint Teflon rouge pour hautes températures.</i>	1302	100
<b>3040127B</b>	Interno valvola lungo nichelato con guarnizione in Teflon rossa per alte temperature. <i>Long valve core nickel plated with red Teflon seal for high temperatures.</i> <i>Partie intérieure longue nickelée avec joint rouge Teflon pour hautes températures.</i>	-	100
<b>3040127N</b>	Interno valvola lungo nichelato con guarnizione in Teflon rossa per alte temperature e filtro (raccomandato per sistema di bilanciatura con microsfer). <i>Long valve core nickel plated with red Teflon seal for high temperatures and filter (to use in combination with microbeads balancing systems).</i> <i>Partie intérieure longue pour valve nickelée avec joint rouge Teflon pour hautes températures et avec filtre (recommandé avec microsphères pour équilibrage).</i>	-	100
<b>3040128</b>	Cappelletto con chiave con guarnizione. <i>Cap with key with seal.</i> <i>Bouchon avec clef avec joint.</i>	VC-2	100
<b>3040129</b>	Cappelletto con guarnizione. <i>Cap with seal.</i> <i>Bouchon avec joint.</i>	VC-3	100
<b>3040129A</b>	Cappelletto esagonale cromato con guarnizione. <i>Chromed hexagonal cap with seal.</i> <i>Bouchon hexagonal chromé avec joint.</i>	-	100
<b>3040129B</b>	Cappelletto in metallo con guarnizione. <i>Metal cap with seal</i> <i>Bouchon en métal avec joint</i>	-	100
<b>3040129C</b>	Cappelletto in alluminio con guarnizione. <i>Aluminium cap with seal</i> <i>Bouchon en aluminium avec joint</i>	-	100
<b>3040129D</b>	Cappelletto in alluminio nero con guarnizione. <i>Aluminium black cap with seal</i> <i>Bouchon en aluminium noir avec joint</i>	-	100



3040126



3040126A



3040126B



3040127



3040127A



3040127B



3040127N



3040128



3040129



3040129A



3040129B



3040129C



3040129D

**VALVOLE ED ACCESSORI**  
**VALVES AND ACCESSORIES**  
**VALVES ET ACCESSOIRES**

Codice Code Code	Descrizione Description Description	Rif. Ref. Réf.	Confezione Box Conditionnement
3040129Q	Cappelletto in nylon corto Nylon short cap Bouchon en nylon court	VC-8S	100
3040130	Cappelletto in nylon lungo Long Nylon cap Bouchon en nylon longue	VC-8	100
3040130A	Cappelletto in nylon colorato rosso Red coloured nylon cap Bouchon en nylon de couleur rouge	-	100
3040130B	Cappelletto in nylon colorato verde Green coloured nylon cap Bouchon en nylon de couleur vert	-	100
3040130C	Cappelletto in nylon colorato giallo Yellow coloured nylon cap Bouchon en nylon de couleur jaune	-	100
3040130D	Cappelletto in nylon colorato blu Blue coloured nylon cap Bouchon en nylon de couleur bleu	-	100
3040130G	Cappelletto in nylon nero con guarnizione Black nylon cap with seal Bouchon en nylon noir avec joint	-	100
3040130H	Cappelletto in nylon blu con guarnizione Blue nylon cap with seal Bouchon en nylon bleu avec joint	-	100
3040130J	Cappelletto in nylon verde con guarnizione Green nylon cap with seal Bouchon en nylon verte avec joint	-	100
3040130N	Cappelletto in plastica con guarnizione specifico per valvole TPMS Plastic sealing cap specific for TPMS valves Bouchon plastique avec joint pour TPMS valves	-	100
3040130R	Cappelletto in nylon con guarnizione e marchio verde N2. Nylon sealing cap with green "N2" mark. Bouchon en nylon avec joint et marque N2 vert	-	100
3040130U	Cappelletto in metallo con guarnizione con marchio verde "N2" Metal sealing cap with green "N2" mark Bouchon vert en metal avec joint et marque "N2"	-	100
3040130V	Cappelletto Genio Civile con intaglio E.M. cap with notching Bouchon Génie Civil avec créneau	-	1
3040130W	Cappelletto Genio Civile piatto Flat E.M. cap Bouchon Génie Civil plat	-	1
3040130Y	Cappelletto Genio Civile con guarnizione E.M. cap with seal. Bouchone Génie Civil avec joint	VC-7	1
3040131	Cappelletto Genio Civile con guarnizione E.M. cap with seal Bouchon Génie Civil avec joint	CV-6	1
3040131A	Cappelletto Double Seal Double Seal cap Bouchon Double Seal	V2B	100
3040132	Riduzione foro valvola in gomma Hole reduction for rubber valve Réduction forure pour valve en caoutchouc	3361	100
3040133	Filiera piccola (1520S) Small die (1520S) Filière petite (1520S)	8501	1
3040135	Filiera valvole VG 5-8-12 standard Die for standard valves VG 5-8-12 Filière pour valves standard VG 5-8-12	-	1
3040136	Filiera valvole VG 5-8-12 Genio Civile Die for E.M. valves VG 5-8-12 Filière pour valves G.C. VG 5-8-12	-	1



3040129Q



3040130



3040130A



3040130B



3040130C



3040130G



3040130H/I/J



3040130N



3040130R



3040130U



3040130V



3040130W



3040130Y



3040131



3040132



3040131A



3040133



3040135



3040136

**Cappelletto double seal Alligator**  
**Double seal cap Alligator**  
**Bouchon double seal Alligator**



3040131A

Il controllo della pressione per camion e altri veicoli commerciali è di estrema importanza in quanto:

- aumenta la durata del pneumatico;
- riduce il consumo del pneumatico;
- garantisce la sicurezza del conducente e del veicolo.

Il controllo della pressione è tuttavia molto oneroso in termini di tempo: svitare il cappelletto, regolare la pressione, riavvitare il cappelletto sono operazioni che per un camion da 18 ruote richiedono molto tempo.

Il cappelletto "Double Seal Cap V2B" dell'Alligator rappresenta una soluzione al problema ed è compatibile con tutti i tipi di valvole. È sufficiente rimuovere il cappelletto originale e sostituirlo avvitando il Double Seal Cap. Non sarà più necessario rimuoverlo per controllare la pressione/aggiungere l'aria. Questa operazione sarà effettuata direttamente attraverso il cappelletto, con un risparmio di tempo e denaro (circa il 65%).

*The pressure control for trucks and other commercial vehicles is extremely important as:*

- it increases the tyre life;
- it reduces the tyre wear;
- it assures safety of the driver and of the vehicle.

*However, the pressure control is very burdensome in terms of time: unscrewing the cap, adjusting pressure, screwing the cap again are operations that, for a truck having 18 tyres, require much time.*

*The "Double Seal Cap V2B" of Alligator represents a solution to the problem and is compatible with all types of valves.*

*It is enough taking off the original cap and replacing it screwing the Double Seal Cap. It won't be anymore necessary taking it off to check pressure / add air. This operation will be carried out directly through the cap, with time and money saving (approx. 65%).*

*Le contrôle de la pression pour camions et d'autres véhicules commerciaux est extrêmement important puisque:*





























- il augmente la durée du pneu;
- il réduit la consommation du pneu;
- il assure la sécurité du conducteur et du véhicule.

*Toutefois, le contrôle de la pression est très onéreux en termes de temps: dévisser le bouchon, régler la pression, visser à nouveau le bouchon sont des opérations qui, pour un camion à 18 pneus, demandent beaucoup de temps.*

*Le bouchon "Double Seal Cap V2B" de Alligator représente une solution au problème et il est compatible avec tous types de valves.*

*Il est suffisant d'enlever le bouchon original et de le remplacer en vissant le Double Seal Cap. Il ne sera plus nécessaire de l'enlever pour contrôler la pression / ajouter de l'air. Cette opération sera faite directement parmi le bouchon, en épargnant temps et argent (env. 65%).*

**Prolunghe in gomma flessibile**  
**Flexible rubber extensions**  
**Rallonges flexibles en caoutchouc**

<b>Codice</b> <i>Code</i> <i>Code</i>	<b>Descrizione</b> <i>Description</i> <i>Description</i>	<b>Note</b> <i>Notes</i> <i>Notes</i>	<b>Lungh. mm</b> <i>Length in mm</i> <i>Longueur en mm</i>	<b>Applicazioni</b> <i>Application</i> <i>Application</i>
3040139	Prolunga in gomma flessibile <i>Flexible rubber extension</i> <i>Rallonge flexible en caoutchouc</i>		75	
3040140	Prolunga in gomma flessibile <i>Flexible rubber extension</i> <i>Rallonge flexible en caoutchouc</i>		105	 
3040140M	Prolunga in gomma flessibile <i>Flexible rubber extension</i> <i>Rallonge flexible en caoutchouc</i>	Michelin	105	 
3040140T	Prolunga in gomma flessibile <i>Flexible rubber extension</i> <i>Rallonge flexible en caoutchouc</i>		125	 
3040141	Prolunga in gomma flessibile <i>Flexible rubber extension</i> <i>Rallonge flexible en caoutchouc</i>		140	 
3040141M	Prolunga in gomma flessibile <i>Flexible rubber extension</i> <i>Rallonge flexible en caoutchouc</i>	Michelin	140	 
3040141T	Prolunga in gomma flessibile <i>Flexible rubber extension</i> <i>Rallonge flexible en caoutchouc</i>		160	 
3040142	Prolunga in gomma flessibile <i>Flexible rubber extension</i> <i>Rallonge flexible en caoutchouc</i>		180	 
3040142M	Prolunga in gomma flessibile <i>Flexible rubber extension</i> <i>Rallonge flexible en caoutchouc</i>	Michelin	180	 
3040143	Prolunga in gomma flessibile <i>Flexible rubber extension</i> <i>Rallonge flexible en caoutchouc</i>		210	 
3040143M	Prolunga in gomma flessibile <i>Flexible rubber extension</i> <i>Rallonge flexible en caoutchouc</i>	Michelin	210	 
3040143T	Prolunga in gomma flessibile <i>Flexible rubber extension</i> <i>Rallonge flexible en caoutchouc</i>		230	
3040143U	Prolunga in gomma flessibile <i>Flexible rubber extension</i> <i>Rallonge flexible en caoutchouc</i>		250	
3040144	Prolunga in gomma flessibile <i>Flexible rubber extension</i> <i>Rallonge flexible en caoutchouc</i>		270	
3040144M	Prolunga in gomma flessibile <i>Flexible rubber extension</i> <i>Rallonge flexible en caoutchouc</i>	Michelin	270	
3040145	Prolunga in gomma flessibile <i>Flexible rubber extension</i> <i>Rallonge flexible en caoutchouc</i>		335	
3040146	Prolunga in gomma flessibile <i>Flexible rubber extension</i> <i>Rallonge flexible en caoutchouc</i>		430	
3040147	Prolunga in gomma flessibile <i>Flexible rubber extension</i> <i>Rallonge flexible en caoutchouc</i>		475	



3040140M



3040141



3040148

-Altre misure disponibili a richiesta  
 -Other sizes available on request  
 -Autres dimensions disponibles sur demande



3040147L



3040148

**Prolunghe in gomma flessibile per Movimento Terra**  
**Flexible rubber extensions for E.M.**  
**Rallonges flexibles en caoutchouc pour G.C.**

<b>Codice</b> Code Code	<b>Descrizione</b> Description Description	<b>Note</b> Notes Notes	<b>Lunghezza mm</b> Length in mm Longueur en mm	<b>Applicazione</b> Application Application
3040147K	Prolunga in gomma con treccia in acciaio G.C. Rubber extension with steel braided hose E.M. Rallonge caoutchouc tuyau acier tressé G.C.	Michelin	180	
3040147L	Prolunga in gomma con treccia in acciaio G.C. Rubber extension with steel braided hose E.M. Rallonge caoutchouc tuyau acier tressé G.C.	Michelin	210	
3040148	Prolunga in gomma flessibile Movim. Terra Flexible rubber extension E.M. Rallonge flexible en caoutchouc G.C.	-	300	
3040148B	Prolunga in gomma con treccia in acciaio G.C. Rubber extension with steel braided hose E.M. Rallonge caoutchouc tuyau acier tressé G.C.	Michelin	310	
3040148C	Prolunga in gomma con treccia in acciaio G.C. Rubber extension with steel braided hose E.M. Rallonge caoutchouc tuyau acier tressé G.C.	Michelin	400	
3040148D	Prolunga in gomma con treccia in acciaio G.C. Rubber extension with steel braided hose E.M. Rallonge caoutchouc tuyau acier tressé G.C.	Michelin	475	
3040148F	Prolunga in gomma con treccia in acciaio G.C. Rubber extension with steel braided hose E.M. Rallonge caoutchouc tuyau acier tressé G.C.	Michelin	600	
3040149	Prolunga in gomma flessibile Movim. Terra Flexible rubber extension E.M. Rallonge flexible en caoutchouc G.C.	-	615	
3040149C	Prolunga in gomma con treccia in acciaio G.C. Rubber extension with steel braided hose E.M. Rallonge caoutchouc tuyau acier tressé G.C.	Michelin	730	
3040149D	Prolunga in gomma con treccia in acciaio G.C. Rubber extension with steel braided hose E.M. Rallonge caoutchouc tuyau acier tressé G.C.	Michelin	800	















3040149L

**Prolunghe in gomma flessibile con attacco ricurvo**  
**Flexible rubber extensions with curved connector**  
**Rallonges flexibles en caoutchouc avec connecteur courbe**

<b>Codice</b> Code Code	<b>Descrizione</b> Description Description	<b>Note</b> Notes Notes	<b>Lunghezza mm</b> Length in mm Longueur en mm	<b>Applicazione</b> Application Application
3040149L	Prolunga in gomma flessibile ad angolo 90° Flexible rubber extension 90° angle Rallonge flexible en caoutchouc angle 90°	1011	140	
3040149N	Prolunga in gomma flessibile ad angolo 90° Flexible rubber extension 90° angle Rallonge flexible en caoutchouc angle 90°	916	210	
3040149P	Prolunga in gomma flessibile ad angolo 90° Flexible rubber extension 90° angle Rallonge flexible en caoutchouc angle 90°	1422	280	
3040149R	Prolunga in gomma flessibile ad angolo 90° Flexible rubber extension 90° angle Rallonge flexible en caoutchouc angle 90°	1104	360	
3040149T	Prolunga in gomma flessibile ad angolo 90° Flexible rubber extension 90° angle Rallonge flexible en caoutchouc angle 90°	1511	460	















**Prolunghe in plastica - Plastic extensions - Rallonges en plastique**

Codice Code Code	Descrizione Description Description	Lungh. mm Length in mm Longueur en mm	Applicazione Application Application
3040150	Prolunga in plastica Plastic extension - Rallonge en plastique	71	 
3040150B	Prolunga in plastica Plastic extension - Rallonge en plastique	95	 
3040151	Prolunga in plastica Plastic extension - Rallonge en plastique	115	 
3040151B	Prolunga in plastica Plastic extension - Rallonge en plastique	125	 
3040152	Prolunga in plastica Plastic extension - Rallonge en plastique	150	 
3040153	Prolunga in plastica Plastic extension - Rallonge en plastique	170	 



3040151















**Prolunghe in plastica con corpo sottile  
 Plastic extensions with slim body - Rallonges en plastique avec corps mince**

Codice Code Code	Descrizione Description Description	Lungh. mm Length in mm Longueur en mm	Applicazione Application Application
3040153D	Prolunga in plastica Plastic extension - Rallonge en plastique	71	 
3040153E	Prolunga in plastica Plastic extension - Rallonge en plastique	95	 
3040153F	Prolunga in plastica Plastic extension - Rallonge en plastique	115	 
3040153G	Prolunga in plastica Plastic extension - Rallonge en plastique	125	 
3040153H	Prolunga in plastica Plastic extension - Rallonge en plastique	150	 
3040153J	Prolunga in plastica Plastic extension - Rallonge en plastique	170	 
3040153K	Prolunga in plastica Plastic extension - Rallonge en plastique	180	 



3040153J

**Prolunghe in plastica con attacco corto  
 Plastic extensions with short connection - Rallonges en plastique avec connexion courte**













Codice Code Code	Descrizione Description Description	Lungh. mm Length in mm Longueur en mm	Applicazione Application Application
3040154A	Prolunga in plastica - Attacco 15mm Plastic extension - 15mm Rallonge en plastique - 15mm	61	 
3040154C	Prolunga in plastica - Attacco 15mm Plastic extension - 15mm Rallonge en plastique - 15mm	85	 
3040154E	Prolunga in plastica - Attacco 15mm Plastic extension - 15mm Rallonge en plastique - 15mm	105	 
3040154G	Prolunga in plastica - Attacco 15mm Plastic extension - 15mm Rallonge en plastique - 15mm	115	 
3040154J	Prolunga in plastica - Attacco 15mm Plastic extension - 15mm Rallonge en plastique - 15mm	140	 
3040154M	Prolunga in plastica - Attacco 15mm Plastic extension - 15mm Rallonge en plastique - 15mm	160	 
3040154P	Prolunga in plastica - Attacco 15mm Plastic extension - 15mm Rallonge en plastique - 15mm	170	 



3040154A

- Ideale per utilizzo con valvola a scatto in gomma (furgoni)
- Best fit with rubber snap-in valve (van/light truck)
- Idéale pour utilisation avec valve à détente en caoutchouc (camionnette)











**Prolunghe rivestite in acciaio**  
**Steel coated extensions**  
**Rallonges habillées en acier**

<b>Codice</b> Code Code	<b>Descrizione</b> Description Description	<b>Lungh. mm</b> Length in mm Longueur en mm	<b>Applicazione</b> Application Application
<b>3040156A</b>	Prolunga rivestita in acciaio Steel coated extension - Rallonge habillée en acier	100	 
<b>3040156C</b>	Prolunga rivestita in acciaio Steel coated extension - Rallonge habillée en acier	140	 
<b>3040156E</b>	Prolunga rivestita in acciaio Steel coated extension - Rallonge habillée en acier	160	 
<b>3040156G</b>	Prolunga rivestita in acciaio Steel coated extension - Rallonge habillée en acier	180	 
<b>3040156N</b>	Prolunga rivestita in acciaio Steel coated extension - Rallonge habillée en acier	210	 
<b>3040156P</b>	Prolunga rivestita in acciaio Steel coated extension - Rallonge habillée en acier	270	 



3040156A

**Prolunghe in ottone**  
**Brass extensions**  
**Rallonges en laiton**

<b>Codice</b> Code Code	<b>Descrizione</b> Description Description	<b>Lungh. mm</b> Length in mm Longueur en mm	<b>Applicazione</b> Application Application
<b>3040158</b>	Prolunga in ottone Brass extension - Rallonge en laiton	40	 
<b>3040159</b>	Prolunga in ottone Brass extension - Rallonge en laiton	60	 
<b>3040160</b>	Prolunga in ottone Brass extension - Rallonge en laiton	84	 
<b>3040161</b>	Prolunga in ottone Brass extension - Rallonge en laiton	100	 
<b>3040162</b>	Prolunga in ottone Brass extension - Rallonge en laiton	125	 



3040160

**Valvole per serbatoi**  
**Valves for tanks**  
**Valves pour réservoirs**













<b>Codice</b> Code Code	<b>Descrizione</b> Description Description
<b>3040165</b>	Valvola industriale per serbatoi 23 mm 1/8" Industrial valve for tanks 23 mm 1/8" Valve industrielle pour réservoirs 23 mm 1/8"
<b>3040165B</b>	Valvola industriale per serbatoi 33 mm 1/8" Industrial valve for tanks 33 mm 1/8" Valve industrielle pour réservoirs 33 mm 1/8"



3040165











**Piastrine di fissaggio - Fixing plates - Pattes de fixation**

Codice Code Code	Descrizione Description Description	Rif. Ref. Réf.	Applicazione Application Application
3040168	Piastrina di fissaggio singola Single fixing plate Patte de fixation single	1144	 
3040169	Piastrina di fissaggio doppia Double fixing plate Patte de fixation double	1431	 
3040170	Piastrina di fissaggio doppia Double fixing plate Patte de fixation double	1144/2	 
3040171	Piastrina di fissaggio universale Universal fixing plate Patte de fixation universelle	-	 
3040172	Piastrina di fissaggio per due prolunghe - tipo Hayon Fixing plate for two extensions - type Hayon Patte de fixation pour deux rallonges - type Hayon	Michelin 798	 
3040173	Piastrina di fissaggio per prolunghe G.C. a foro largo Fixing plate for large bore extensions E.M. Patte de fixation pour rallonges G.C. à trou large	Michelin 883	 







**Prolunghe in ottone - Brass extensions - Rallonges en laiton**

Codice Code Code	Descrizione Description Description	Rif. Ref. Réf.	$\alpha$ $\alpha$ $\alpha$	Lungh. mm Length in mm Longueur en mm	Applicazione Application Application
3040175	Prolunga in ottone Brass extension Rallonge en laiton	8071	90°	34	 
3040175C	Prolunga in ottone alta prestazione High performance brass extension Rallonge en laiton haute performance	0352	90°	34	 
3040176	Prolunga in ottone Brass extension Rallonge en laiton	8076	45°	29	 
3040176C	Prolunga in ottone alta prestazione High performance brass extension Rallonge en laiton	0353	45°	29	 



**Coperchietti prolunga - Extension caps - Bouchons pour rallonge**

Codice Code Code	Descrizione Description Description	Rif. Ref. Réf.	Lungh. mm Length in mm Longueur en mm	Applicazione Application Application
3040177	Coperchietto prolunga in plastica Plastic extension cap Bouchon pour rallonge en plastique	7226	19	
3040178	Coperchietto prolunga in plastica Plastic extension cap Bouchon pour rallonge en plastique	7227	32	
3040180	Coperchietto prolunga in metallo Metal extension cap Bouchon pour rallonge en métal	-	19	
3040181	Coperchietto prolunga in metallo Metal extension cap Bouchon pour rallonge en métal	-	32	



**Accessori per valvole e prolunghe**  
**Accessories for valves and extensions**  
**Accessoires pour valves et rallonges**

<b>Codice</b> <i>Code</i> <i>Code</i>	<b>Descrizione</b> <i>Description</i> <i>Description</i>	<b>Rif.</b> <i>Ref.</i> <i>Réf.</i>
3040183H	Svita interni singolo <i>Single unscrew for inside parts</i> <i>Dispositif individuel pour dévisser les parties intérieures</i>	-
3040184	Svita interni singolo <i>Single unscrew for inside parts</i> <i>Dispositif individuel pour dévisser les parties intérieures</i>	-
3040184A	Svita interni singolo lungo <i>Single long unscrew for inside parts</i> <i>Dispositif long individuel pour dévisser les parties intérieures</i>	-
3040184B	Svita interni singolo dinamometrico (vettura) <i>Single dynamometrical unscrew for inside parts (car)</i> <i>Disp. dynamometrique individuel pour dévisser les parties intérieures (voiture)</i>	-
3040184C	Svita interni singolo dinamometrico (autocarro) <i>Single dynamometrical unscrew for inside parts (truck)</i> <i>Disp. dynamometrique individuel pour dévisser les parties intérieures (camion)</i>	-
3040185	Svita interni in plastica - vettura/G.C. <i>Plastic unscrew for inside parts - car/E.M.</i> <i>Dispositif en plastique pour dévisser les parties intérieures - voiture/G.C.</i>	1617
3040185K	Kit 2 svite interni dinamometrici (vettura+autocarro) <i>Kit of 2 dynamometrical unscrew for inside parts (car+truck)</i> <i>Kit de 2 disp. dynamometrique pour dévisser les parties intérieures (voiture+camion)</i>	-
3040186	Svita interni in metallo <i>Metal unscrew for inside parts</i> <i>Dispositif en métal pour dévisser les parties intérieures</i>	1614
3040186A	Svita interni in alluminio calamitato <i>Aluminium unscrew for inside parts with magnet</i> <i>Dispositif en aluminium pour dévisser les parties intérieures avec aimant</i>	-
3040186C	Svita interni in alluminio calamitato per autocarro 151 mm <i>Truck aluminium unscrew for inside parts with magnet 151 mm</i> <i>Dispositif en aluminium pour dévisser les parties intérieures avec aimant pour camion 151 mm</i>	-



<b>Codice</b> <i>Code</i> <i>Code</i>	<b>Descrizione</b> <i>Description</i> <i>Description</i>	<b>Rif.</b> <i>Ref.</i> <i>Réf.</i>
3040187	Attrezzo smontaggio cappelletti <i>Tool to demount caps</i> <i>Outil pour démonter les bouchons</i>	9055
3040187C	Attrezzo smontaggio cappelletti valvole G.C. foro largo <i>Tool to demount caps of large bore E.M. valves</i> <i>Outil pour démonter les bouchons valves G.C. à trou large</i>	-



<b>Codice</b> <i>Code</i> <i>Code</i>	<b>Descrizione</b> <i>Description</i> <i>Description</i>	<b>Rif.</b> <i>Ref.</i> <i>Réf.</i>
3040195	Raccordo di gonfiaggio - Doife (passaggio aria diretto) <i>Inflating connector - Doife (open end)</i> <i>Connecteur de gonflage - Doife (passage air direct)</i>	8182
3040196	Raccordo di gonfiaggio - Genio Civile (passaggio aria diretto) <i>Inflating connector - E.M. (open end)</i> <i>Connecteur de gonflage - Génie Civil (passage air direct)</i>	8183

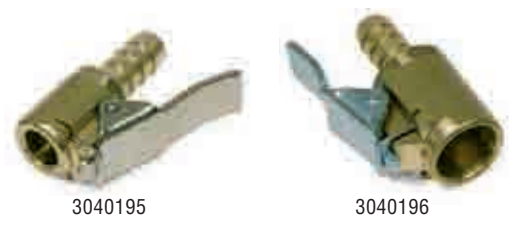

<b>Codice</b> <i>Code</i> <i>Code</i>	<b>Descrizione</b> <i>Description</i> <i>Description</i>	<b>Rif.</b> <i>Ref.</i> <i>Réf.</i>
3040200	Svuotacamera in acciaio <i>Steel deflator for tubes</i> <i>Dispositif de dégonflage en acier pour chambres</i>	1589



**VALVOLE ED ACCESSORI**  
**VALVES AND ACCESSORIES**  
**VALVES ET ACCESSOIRES**



3040201



3040202



3040202A



3040202B

**Misuratori battistrada**  
**Treads measurer**  
**Mesureurs de la chape**

Codice Code Code	Descrizione Description Description	Rif. Ref. Réf.
3040201	Misuratore battistrada <i>Tread measurer - Mesureur de la chape</i>	9796
3040202	Misuratore battistrada in astuccio <i>Tread measurer in sheath - Mesureur de la chape en étui</i>	-
3040202A	Misuratore battistrada digitale <i>Digital tread measurer - Mesureur digital de la chape</i>	-
3040202B	Misuratore battistrada digitale economico <i>Cheap digital tread measurer Mesureur de la chape digital économique</i>	-
3040202D	Misuratore battistrada con quadrante analogico 0-20 mm <i>Tread measurer with analogic dial 0-20 mm Mesureur de la chape avec cadran analogique 0-20 mm</i>	-
3040202T	Misuratore battistrada per autocarro 0-90 <i>Truck tread measurer 0-90 Mesureur de la chape camion 0-90</i>	-
3040202U	Misuratore battistrada per OTR 0-145mm <i>OTR tyre tread measurer 0-145mm Mesureur de la chape OTR 0-145mm</i>	-



3040202D



3040202T



3040202U

**Attrezzi per riempimento/svuotamento acqua**  
**Tools for water filling/emptying**  
**Outils pour remplissage/vidage eau**

Codice Code Code	Descrizione Description Description	Rif. Ref. Réf.
3040203	Attrezzo svuotamento acqua <i>Water emptying tool / Outil pour vidage eau</i>	680
3040204	Attrezzo riempimento acqua <i>Water filling tool / Outil pour remplissage eau</i>	685/686
3040204W	Set completo riempimento/svuotamento acqua <i>Complete set for water filling/emptying Jeu complet pour remplissage/vidage eau</i>	-



3040203



3040204W

<b>Codice</b> Code Code	<b>Descrizione</b> Description Description	<b>Rif.</b> Ref. Réf.
<b>3040205</b>	Attrezzo montaggio valvole in metallo <i>Tool for metal valves mounting - Outil en métal pour monter les valves</i>	9092
<b>3040205B</b>	Attrezzo montaggio valvole in metallo con protezione in gomma <i>Tool for metal valves mounting with rubber protection Outil pour monter les valves en métal avec protection en caoutchouc</i>	-
<b>3040206</b>	Attrezzo montaggio valvole in plastica <i>Plastic tool for valves mounting Outil en plastique pour monter les valves</i>	-
<b>3040206A</b>	Attrezzo Alligator montaggio valvole in plastica <i>Alligator plastic tool for valves mounting Outil Alligator en plastique pour monter les valves</i>	23.1900
<b>3040206B</b>	Attrezzo Alligator montaggio valvole in plastica. Con aggancio rapido valvola <i>Alligator plastic tool for valves mounting. With valve coupling Outil Alligator en plastique pour monter les valves. Avec couplage valve</i>	23.1930
<b>3040206C</b>	Attrezzo Alligator montaggio valvole in plastica. Con svita interni incorporato <i>Alligator plastic tool for valves mounting. With incorporated screwdriver Outil Alligator en plastique pour monter les valves. Avec dispositif pour dévisser les parties intérieures</i>	23.1940
<b>3040207</b>	Attrezzo montaggio prolunghe flessibili e rigide <i>Tool to mount flexible and stiff extensions Outil pour montage rallonges flexibles et rigides</i>	-
<b>3040207A</b>	Attrezzo di pescaggio valvole nel montaggio pneumatici <i>Tool to hook valves in tyre mounting Outil accroche-valves pour le montage des pneus</i>	-
<b>3040207B</b>	Attrezzo montaggio/smontaggio valvole in gomma <i>Tool to mount/demount rubber valves Outil pour monter/démonter les valves en caoutchouc</i>	-
<b>3040207F</b>	Kit per il montaggio/smontaggio valvole snap-in senza necessità di smontare il pneumatico <i>Kit to mount/demount snap-in valves without need to demount the tyre Kit pour monter/démonter les valves snap-in sans besoin de démonter le pneu</i>	-



<b>Codice</b> Code Code	<b>Descrizione</b> Description Description	<b>Rif.</b> Ref. Réf.
<b>3040208</b>	Attrezzo di gonfiaggio senza manico <i>Inflating tool without handle / Outil de gonflage sans poignée</i>	1590
<b>3040209</b>	Attrezzo di gonfiaggio con manico lungo con raccordo <i>Inflating tool with long handle with connector Outil de gonflage avec poignée longue avec raccord</i>	1591
<b>3040209D</b>	Pipa a testina girevole per valvole standard <i>Pipe with swivel single foot chuck for standard bore valves Pipe de prise de pression pour valves standard</i>	Michelin 415
<b>3040209E</b>	Pipa a testina girevole per valvole standard e grande sezione <i>Pipe with swivel dual foot chuck for standard bore and for large bore valves Pipe de prise de pression pour valves standard et G.C.</i>	
<b>3040210</b>	Chiave di serraggio per valvole in metallo <i>Tightening wrench for metal valves Clef de serrage pour valves en métal</i>	1591



# CONNETTORI E INDICATORI DI CONTROLLO PER DADI

## CONNECTORS AND INDICATORS FOR TRUCK WHEEL NUTS

### CONNECTEURS ET INDICATEURS POUR ÉCROUS

#### Connettori, indicatori di controllo per dadi cerchi autocarro

#### Truck wheel nut check connectors and indicators

#### Connecteurs et indicateurs pour écrous jantes camion

Codice Code Code	Descrizione Description Description	Misura dado Nut size Dimension écrous	Pz. Pcs. Pcs
3040500	Indicatore di controllo tenuta dadi resistente ad alte temperature Wheel nut sealing indicator resistant to high temperatures Indicateur d'étanchéité des écrous résistant aux températures élevées	21 mm	50
3040500C	Indicatore di controllo tenuta dadi resistente ad alte temperature Wheel nut sealing indicator resistant to high temperatures Indicateur d'étanchéité des écrous résistant aux températures élevées	24 mm	50
3040500E	Indicatore di controllo tenuta dadi resistente ad alte temperature Wheel nut sealing indicator resistant to high temperatures Indicateur d'étanchéité des écrous résistant aux températures élevées	27 mm	50
3040500H	Indicatore di controllo tenuta dadi resistente ad alte temperature Wheel nut sealing indicator resistant to high temperatures Indicateur d'étanchéité des écrous résistant aux températures élevées	30 mm	50
3040500K	Indicatore di controllo tenuta dadi resistente ad alte temperature Wheel nut sealing indicator resistant to high temperatures Indicateur d'étanchéité des écrous résistant aux températures élevées	32 mm	50
3040500N	Indicatore di controllo tenuta dadi resistente ad alte temperature Wheel nut sealing indicator resistant to high temperatures Indicateur d'étanchéité des écrous résistant aux températures élevées	33 mm	50
3040502E	Indicatore di controllo tenuta dadi con tappo para polvere Wheel nut sealing indicator with dust cap Indicateur d'étanchéité des écrous avec bouchon pour poussière	27 mm	50
3040502H	Indicatore di controllo tenuta dadi con tappo para polvere Wheel nut sealing indicator with dust cap Indicateur d'étanchéité des écrous avec bouchon pour poussière	30 mm	50
3040502K	Indicatore di controllo tenuta dadi con tappo para polvere Wheel nut sealing indicator with dust cap Indicateur d'étanchéité des écrous avec bouchon pour poussière	32 mm	50
3040502N	Indicatore di controllo tenuta dadi con tappo para polvere Wheel nut sealing indicator with dust cap Indicateur d'étanchéité des écrous avec bouchon pour poussière	33 mm	50
3040504H	Connettore dadi - Wheel nut connector - Connecteur des écrous	30 mm	10
3040504K	Connettore dadi - Wheel nut connector - Connecteur des écrous	32 mm	10
3040504N	Connettore dadi - Wheel nut connector - Connecteur des écrous	33 mm	10
3040506E	Connettore dadi in metallo plastificato Metal wheel nut connector powder coated Connecteur des écrous en métal plastifié	27 mm	10
3040506H	Connettore dadi in metallo plastificato Metal wheel nut connector powder coated Connecteur des écrous en métal plastifié	30 mm	10
3040506K	Connettore dadi in metallo plastificato Metal wheel nut connector powder coated Connecteur des écrous en métal plastifié	32 mm	10
3040506N	Connettore dadi in metallo plastificato Metal wheel nut connector powder coated Connecteur des écrous en métal plastifié	33 mm	10



3040500

OK



3040502E

KO



3040504H



3040506E



# COPERCHIETTI PER DADI CERCHI AUTOCARRO E VETTURA

TRUCK AND CARS WHEEL NUT CAPS

BOUCHONS POUR ÉCROUS JANTES CAMION ET VOITURE

italmatic

## Coperchietti per dadi cerchi autocarro e vettura

Truck and cars wheel nut caps

Bouchons pour écrous jantes camion et voiture

Codice Code Code	Descrizione Description Description	Misura dado Nut size Dimension écrous	Pz. Pcs. Pcs
3040520	Copri bulloni in ABS Bolts cover in ABS Couvre boulons en ABS	32 mm	10
3040520A	Copri bulloni in ABS Bolts cover in ABS Couvre boulons en ABS	33 mm	10
3040520F	Copri bulloni in acciaio Inox Bolts cover in stainless steel Couvre boulons en acier inoxydable	32 mm	10
3040520G	Copri bulloni in acciaio Inox Bolts cover in stainless steel Couvre boulons en acier inoxydable	33 mm	10
3040520J	Copri bulloni in metallo Bolts cover in metal Couvre boulons en métal	32 mm	10
3040520K	Copri bulloni in metallo Bolts cover in metal Couvre boulons en métal	33 mm	10
3040520P	Copri bulloni universali in ABS cromato Universal bolts cover in chromed ABS Couvre boulons universels en ABS chromé	32/33 mm	10
3040520Q	Copri bulloni universali in ABS rosso Universal bolts cover in red ABS Couvre boulons universels en ABS rouge	32/33 mm	10
3040520R	Copri bulloni universali in ABS nero Universal bolts cover in black ABS Couvre boulons universels en ABS noir	32/33 mm	10
3040521	Copri bulloni per auto in ABS, con attrezzo montaggio in dotazione Bolts cover for car in ABS, equipped with mounting tool Couvre boulons pour tourisme en ABS, équipé avec outil de montage	17 mm	20
3040521A	Copri bulloni per auto in ABS, con attrezzo montaggio in dotazione Bolts cover for car in ABS, equipped with mounting tool Couvre boulons pour tourisme en ABS, équipé avec outil de montage	19 mm	20
3040521D	Copri bulloni per auto in acciaio cromato, con attrezzo montaggio in dotazione Bolts cover for car in chromed steel, equipped with mounting tool Couvre boulons pour tourisme en acier chromé, équipé avec outil de montage	17 mm	20
3040521E	Copri bulloni per auto in acciaio cromato, con attrezzo montaggio in dotazione Bolts cover for car in chromed steel, equipped with mounting tool Couvre boulons pour tourisme en acier chromé, équipé avec outil de montage	19 mm	20
3040525	Attrezzo rimuovi coperchietto dado Nut cap puller tool Outil pour démonter le bouchon de l'écrou	-	1
3040527	Attrezzo rimuovi coperchietto dado Nut cap puller tool Outil pour démonter le bouchon de l'écrou	-	1



3040520



3040520J



3040520P



3040521



3040521D



3040525



3040527

# TASSELLI E COLONNETTE

## SMALL BLOCKS AND STUDS

### PETIT BLOCS ET BOULONS

#### Tasselli

##### Small blocks

##### Petits blocs

Codice Code Code	Descrizione Description Description	Ø foro Ø hole Ø forure
3050001	Tassello anteriore Trilex Trilex front small block Petit bloc antérieur Trilex	18
3050002	Tassello posteriore Trilex Trilex back small block Petit bloc postérieur Trilex	18
3050006	Tassello anteriore Trilex 650 Trilex 650 front small block Petit bloc antérieur Trilex 650	16
3050007	Tassello posteriore Trilex 650 Trilex 650 back small block Petit bloc postérieur Trilex 650	16
3050010	Tassello anteriore Trilex 330 Trilex 330 front small block Petit bloc antérieur Trilex 330	20
3050011	Tassello posteriore Trilex 330 Trilex 330 back small block Petit bloc postérieur Trilex 330	20



3050001



3050002



3050006



3050007



3050010



3050011

#### Colonnette per ruote a raggiera

##### Studs for spoked wheels

##### Boulons pour roues en éventail

Codice Code Code	Descrizione Description Description	Misura Size Dimension
3050016	Colonneta con dado Stud c/w nut Boulon avec écrou	16 x 55
3050017	Colonneta con dado Stud c/w nut Boulon avec écrou	16 x 75
3050019	Colonneta con dado Stud c/w nut Boulon avec écrou	16 x 110
3050021	Colonneta con dado Stud c/w nut Boulon avec écrou	18 x 55
3050022	Colonneta con dado Stud c/w nut	18 x 105
3050024	Colonneta con dado Stud c/w nut Boulon avec écrou	18 x 125
3050028	Colonneta ant. con dado per 330 Front stud c/w nut for 330 Boulon ant. avec écrou pour 330	20 x 60
3050029	Colonneta post. con dado per 330 Back stud c/w nut for 330 Boulon post. avec écrou pour 330	20 x 115



3050022



3050029

**Colonneta per autocarro - Studs for truck - Boulons pour camion**

Codice Code Code	Descrizione Description Description	Misura Size Dimension
3050030	Colonneta ant. per Scania 142/143 Front stud for Scania 142/143 - Boulon antérieur pour Scania 142/143	7/8" x 68
3050031	Colonneta post. per Scania 142/143 Back stud for Scania 142/143 - Boulon postérieur pour Scania 142/143	7/8" x 85
3050032	Colonneta ant. per Iveco Front stud for Iveco - Boulon antérieur pour Iveco	22 x 86
3050033	Colonneta post. per Iveco Back stud for Iveco - Boulon postérieur pour Iveco	22 x 100
3050033A	Colonneta post. per Iveco Back stud for Iveco - Boulon postérieur pour Iveco	22 x 110
3050034	Colonneta ant. per Mercedes Front stud for Mercedes - Boulon antérieur pour Mercedes	22 x 80
3050034A	Colonneta post. per Mercedes Back stud for Mercedes - Boulon postérieur pour Mercedes	22 x 100



3050033

**Dadi e rondelle per colonnetta**  
**Nuts and washers for studs - Écrous et rondelles pour boulons**

Codice Code Code	Descrizione Description Description	Misura Size Dimension	Chiave Key Cléf
3050035	Dado per colonnetta - Nut for stud - Écrou pour boulon	16 x 2	27
3050036	Dado per colonnetta - Nut for stud - Écrou pour boulon	18 x 1,5	27
3050037	Dado per colonnetta - Nut for stud - Écrou pour boulon	18 x 2,5	27
3050040	Dado per colonnetta con rondella girevole Nut for stud c/w rotary washer - Écrou pour boulon avec rondelle tournante	18 x 1,5	27
3050041	Dado per colonnetta con rondella girevole Nut for stud c/w rotary washer - Écrou pour boulon avec rondelle tournante	20 x 1,5	30
3050042	Dado per colonnetta con rondella girevole Nut for stud c/w rotary washer - Écrou pour boulon avec rondelle tournante	22 x 1,5	32
3050043	Dado per colonnetta con rondella girevole Nut for stud c/w rotary washer - Écrou pour boulon avec rondelle tournante	22 x 1,5	33
3050044	Dado per colonnetta con rondella girevole Nut for stud c/w rotary washer - Écrou pour boulon avec rondelle tournante	7/8" x 11	33
3050048	Dado per colonnetta con battuta Nut with ledge for stud - Écrou avec bordure pour boulon	20 x 2	27
3050049	Dado per colonnetta con battuta Nut with ledge for stud - Écrou avec bordure pour boulon	22 x 1,5	30
3050055	Rondella per colonnetta bombata foro ø 18/20 Convex washer for stud hole ø 18/20 - Rondelle bombée pour boulon forure ø 18/20		
3050056	Rondella per colonnetta bombata foro ø 22 Convex washer for stud hole ø 22 - Rondelle bombée pour boulon forure ø 22		
3050057	Rondella per colonnetta spaccata foro ø 18/20 Split washer for stud hole ø 18/20 - Rondelle fendue pour boulon forure ø 18/20		
3050058	Rondella per colonnetta spaccata foro ø 22 Split washer for stud hole ø 22 - Rondelle fendue pour boulon forure ø 22		



3050036



3050042



3050048



3050055



3050058

**Colonneta per vettura - Studs for car - Boulons pour tourisme\***

3050065	Colonneta per vettura - Stud for car - Boulon pour tourisme	12 x 37 x 1,25
3050067	Colonneta per vettura - Stud for car - Boulon pour tourisme	12 x 47 x 1,25
3050069	Colonneta per vettura - Stud for car - Boulon pour tourisme	12 x 55 x 1,25
3050070	Colonneta per vettura - Stud for car - Boulon pour tourisme	14 x 52 x 1,50



3050067

\* Disponibili solo su richiesta in funzione delle quantità ordinate

Available only on request according to the quantities ordered / Disponibles seulement sur demande selon les quantités commandées



**ATTREZZI PER CONTRAPPESI**  
**TOOLS FOR BALANCING WEIGHTS**  
**OUTILS POUR MASSES D'ÉQUILIBRAGE**

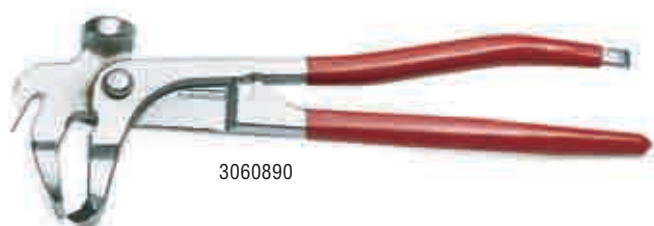

3060890



3060893

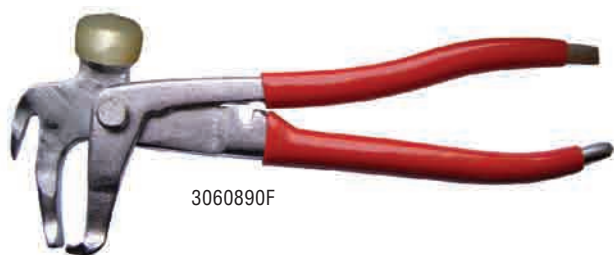

3060890F



3060893A



3060892



3060894



3060892C



3060895

Codice Code Code	Descrizione Description Description
3060890	Pinza per contrappesi / Pliers for balancing weights / Pincas pour masses d'équilibrage
3060890F	Pinza per contrappesi con protezione Pliers for balancing weights with protection Pincas pour masses d'équilibrage avec protection
3060892	Attrezzo rimuovi barrette adesive / Adhesive weights remover / Outil pour enlever les masses à coller
3060892C	Attrezzo rimuovi barrette adesive con dispositivo di taglio Adhesive weights remover with cutting device Outil pour enlever les masses à coller avec dispositif de coupe
3060893	Attrezzo speciale per montaggio contrappesi a molla Special tool to mount clip weights / Outil spécial pour le montage des masses d'équilibrage avec clip
3060893A	Strumento per comprimere il tallone del pneumatico durante il montaggio dei contrappesi con molla separata Special tool for manual type bead compression for the insertion of weights with detached clip. Outil spécial pour comprimer le talon du pneu pendant le montage des masses d'équilibrage avec clip séparé
3060894	Attrezzo montaggio/smontaggio contrappesi molla staccata Tool to mount/demount balancing weights with detached clip / Outil pour monter/démonter les masses d'équilibrage avec clip détaché
3060895	Strumento per montaggio contrappesi per cerchi a raggio Tool to mount wheel weights on spoke rims / Outil pour monter les masses d'équilibrage sur jantes à rayons
3060896B	Ruota in gomma rimuovi nastro adesivo con adattatore gambo Ø 6mm (max 4.000 giri/min.) Rubber wheel to remove adhesive tape with adaptor stem Ø 6mm (max 4.000 RPM) Roue en caoutchouc pour enlever le ruban adhésif avec adaptateur tige Ø 6mm (max 4.000 tours/min.)
3060896C	Ruota gomma dentata rimuovi residui nastro adesivo dal cerchio lega c/adattatore (4.000 giri/min) Toothed rubber wheel to take off residues of adhesive tape from alloy rims with adaptor (4.000 RPM) Roue dentée en caoutchouc pour enlever les résidus de ruban adhésif des jantes en alliage avec adaptateur (4.000 tours/min.)



3060896B



3060896C



3060896G



3060898B



3060898G



3060898K



3060900A

3060900B

<b>Codice</b> <i>Code</i> <i>Code</i>	<b>Descrizione</b> <i>Description</i> <i>Description</i>
<b>3060896G</b>	Smerigliatrice a velocità variabile 0 : 4.000 giri/min. per codice 3060896 <i>Variable speed grinder 0 : 4.000 RPM for code 3060896 / Ponceuse à vitesse variable 0 : 4.000 tours/min. pour code 3060896</i>
<b>3060898B</b>	Mazzuola antirimbalo diametro 35 mm con manico in legno <i>Antibouncing mallet diameter 35 mm with wooden handle</i> <i>Maillet anti ricochet diamètre 35 mm avec manche en bois</i>
<b>3060898C</b>	Mazzuola antirimbalo diametro 40 mm con manico in legno <i>Antibouncing mallet diameter 40 mm with wooden handle</i> <i>Maillet anti ricochet diamètre 40 mm avec manche en bois</i>
<b>3060898G</b>	Mazzuola diametro 35 mm con battenti in poliuretano <i>Mallet diameter 35 mm with polyurethane head</i> <i>Maillet diamètre 35 avec tête en polyuréthane</i>
<b>3060898H</b>	Mazzuola diametro 42 mm con battenti in poliuretano <i>Mallet diameter 42 mm with polyurethane head</i> <i>Maillet diamètre 42 avec tête en polyuréthane</i>
<b>3060898K</b>	Mazzuola monolitica diametro 40 mm in gomma nera <i>Monolithic mallet diameter 40 mm in black rubber</i> <i>Maillet monolithique diamètre 40 mm en caoutchouc noir</i>
<b>3060900A</b>	Solvente speciale Tire-R-Bond Norton Saint Gobain per massimizzare l'adesione dei pesi adesivi in condizioni estreme - 5 litri <i>Special solution "Tire-R-Bond" to maximize adhesive weights tape performance under extreme application conditions - 5 liters</i> <i>Solvant spécial "Tire-R-Bond" Norton Saint Gobain pour maximiser l'adhésion des masses adhésives en conditions extrêmes - 5 litres</i>
<b>3060900B</b>	Solvente speciale Tire-R-Bond Norton Saint Gobain per massimizzare l'adesione dei pesi adesivi in condizioni estreme - 1 litro <i>Special solution "Tire-R-Bond" to maximize adhesive weights tape performance under extreme application conditions - 1 liter</i> <i>Solvant spécial "Tire-R-Bond" Norton Saint Gobain pour maximiser l'adhésion des masses adhésives en conditions extrêmes - 1 litre</i>

# CONTRAPPESI DI BILANCIATURA IN PIOMBO

## LEAD BALANCING WEIGHTS

## MASSSES D'ÉQUILIBRAGE EN PLOMB

In base alla normativa UE "2000/53/CE" i contrappesi di piombo nell'Unione Europea non sono consentiti su autoveicoli (veicoli a motore appartenenti alle categorie M1 ed N1 di cui all'allegato II, parte A, della direttiva 70/156/CE), ed i veicoli a motore a tre ruote come definiti dalla direttiva 2002/24/CE, con esclusione dei tricicli a motore. Pertanto nell'Unione Europea i contrappesi in piombo sono regolarmente consentiti solo per Motocicli e Camion. Per tutte le altre tipologie di veicoli (automobili e veicoli commerciali) devono essere applicati contrappesi senza piombo (zinco, ferro, stagno)

According to UE rule "2000/53/CE" the lead balancing weights in the European Union are not allowed on motor vehicles (motor vehicles being part of categories M1 and N1 mentioned in enclosure II, part A, of directive 70/156/CE), and motor vehicles with three wheels as mentioned in directive 2002/24/CE, with the exclusion of motor tricycles. Therefore, in the European Union lead weights are regularly allowed only for motorcycles and trucks. For all remaining kinds of vehicles (cars and commercial vehicles) no lead balancing weights have to be applied (zinc, steel, tin).

Selon la directive UE "2000/53/CE" les masses en plomb dans l'Union Européenne ne sont pas permises sur les véhicules automobiles (véhicules à moteur étant partie des catégories M1 et N1 à la pièce jointe II, partie A, de la directive 70/156/CE), et les véhicules à moteur à trois roues comme indiqué dans la directive 2002/24/CE, à l'exclusion des triporteurs à moteur. Donc dans l'Union Européenne les masses en plomb sont régulièrement permises seulement pour motocycles et camions. Pour tous autres types de véhicules (voitures et véhicules commerciaux) des masses sans plomb doivent être appliquées (zinc, acier, étain).



3060206

### MOD. S/1

Contrappesi universali per cerchi in ferro.  
Universal balancing weights for steel rims.  
Masses d'équilibrage universelles pour jantes en acier.

Codice Code Code	Grammi Grams Grammes	Pz. / scatola Pcs. / box Pcs. / boîte
3060201	5	100
3060202	10	100
3060203	15	100
3060204	20	100
3060205	25	100
3060206	30	100
3060207	35	100
3060208	40	100
3060209	45	50
3060210	50	50
3060211	55	50
3060212	60	50



3060406

### MOD. SP

Contrappesi universali per cerchi in lega leggera.  
Universal balancing weights for light alloy rims.  
Masses d'équilibrage universelles pour jantes en alliage léger.

Codice Code Code	Grammi Grams Grammes	Pz. / scatola Pcs. / box Pcs. / boîte
3060401	5	100
3060402	10	100
3060403	15	100
3060404	20	100
3060405	25	100
3060406	30	100
3060407	35	100
3060408	40	100
3060409	45	50
3060410	50	50
3060411	55	50
3060412	60	50



3060631

### MOD. 55

Contrappesi autocarro per cerchi in lega "Alcoa" mod. 55 per lato esterno  
Truck weights for "Alcoa" alloy rims mod. 55 for outside  
Masses d'équilibrage camion pour jantes en alliage "Alcoa" mod. 55 pour côté extérieur

Codice Code Code	Grammi Grams Grammes	Pz. / scatola Pcs. / box Pcs. / boîte
3060630	75	10
3060631	100	10
3060632	125	10

Mod. 56: utilizzarlo sul lato interno ed esterno per i cerchi Alcoa prodotti dopo il 1996.

Mod. 56: use it on the inside and outside for Alcoa rims produced after 1996.

Mod. 56: à être utilisé sur le côté intérieur et extérieur pour les jantes Alcoa produites après 1996.



3060636

3060639

### MOD. 56

Contrappesi autocarro per cerchi in lega "Alcoa" mod. 56 per lato interno  
Truck weights for "Alcoa" alloy rims mod. 56 for inside  
Masses d'équilibrage camion pour jantes en alliage "Alcoa" mod. 56 pour côté intérieur

Codice Code Code	Grammi Grams Grammes	Pz. / scatola Pcs. / box Pcs. / boîte
3060635	75	10
3060636	100	10
3060637	125	10
3060639	Molla Clip Clip	10

# CONTRAPPESI DI BILANCIATURA IN PIOMBO

LEAD BALANCING WEIGHTS

MASSSES D'ÉQUILIBRAGE EN PLOMB

italmatic



3060663

## MOD. DUCATO

Contrappesi per cerchi trasporto leggero (Ducato, Master, VW Transporter, ecc.)  
Weights for light truck rims (Ducato, Master, VW Transporter, etc.)  
Masses d'équilibrage pour jantes camionnette (Ducato, Master, VW Transporter, ecc.)

Codice Code Code	Grammi Grams Grammes	Pz. / scatola Pcs. / box Pcs. / boîte
3060660	10	100
3060661	15	100
3060662	20	100
3060663	25	100
3060664	30	100
3060665	40	100
3060666	50	50
3060667	60	50
3060668	70	50
3060669	80	50



3060672

## MOD. F 650

Contrappesi per cerchi autocarro con anello elastico  
Weights for truck rims with elastic ring  
Masses d'équilibrage pour jantes camion avec anneau élastique

Codice Code Code	Grammi Grams Grammes	Pz. / scatola Pcs. / box Pcs. / boîte
3060670	50	50
3060671	100	50
3060672	150	25
3060673	200	25
3060674	250	25



3060703

## MOD. T.A.

Contrappesi universali per cerchi tubeless autocarro  
Universal balancing weights for truck tubeless rims  
Masses d'équilibrage universelles pour jantes tubeless camion

Codice Code Code	Grammi Grams Grammes	Pz. / scatola Pcs. / box Pcs. / boîte
3060701	50	50
3060702	75	50
3060703	100	50
3060704	150	25
3060705	200	25
3060706	250	25
3060707	300	20
3060708	350	10
3060709	400	10
3060710	450	10
3060711	500	10



3060723

## MOD. MOTO

Contrappesi per cerchi moto a raggio  
Weights for motorcycle rims with spokes  
Masses d'équilibrage pour jantes motorcycle avec rayon

Codice Code Code	Grammi Grams Grammes	Pz. / scatola Pcs. / box Pcs. / boîte
3060720	10	50
3060721	15	50
3060722	20	50
3060723	25	50
3060724	30	50



3060216C

## 100GR CWB

Peso 100gr. per calibratura macchine equilibratrici (colore su richiesta)  
100gr. wheel weight to calibrate wheel balancing machines (colour on request)  
Masse 100gr. pour calibrer les machines d'équilibrage (couleur sur demande)

Codice Code Code	Grammi Grams Grammes	Pz. / scatola Pcs. / box Pcs. / boîte
3060750C	100	50

# CONTRAPPESI DI BILANCIATURA IN PIOMBO

## LEAD BALANCING WEIGHTS

## MASSES D'ÉQUILIBRAGE EN PLOMB

		
H : 4.8 mm W : 15 mm L : 108.5 mm		
<b>BARRETTA ADESIVA DA 60 gr</b> <b>ADHESIVE WEIGHT 60 gr - MASSE À COLLER 60 gr</b>		
Codice Code Code	Grammi Grams Grammes	Pz. / scatola Pcs. / box Pcs. / boîte
3060800	5 gr x 4 + 10 gr x 4	100

		
H : 3.8 mm W : 19 mm L : 108.5 mm		
<b>BARRETTA ADESIVA DA 60 gr SLIM</b> <b>ADHESIVE WEIGHT 60 gr SLIM - MASSE À COLLER 60 gr SLIM</b>		
Codice Code Code	Grammi Grams Grammes	Pz. / scatola Pcs. / box Pcs. / boîte
3060802	5 gr x 4 + 10 gr x 4	100

		
H : 5.3 mm W : 15 mm L : 108.5 mm		
<b>BARRETTA ADESIVA DA 60 gr</b> <b>ADHESIVE WEIGHT 60 gr - MASSE À COLLER 60 gr</b>		
Codice Code Code	Grammi Grams Grammes	Pz. / scatola Pcs. / box Pcs. / boîte
3060804	5 gr x 12	100

		
H : 4.8 mm W : 15 mm L : 108.5 mm		
<b>BARRETTA ADESIVA DA 60 gr CROMATA - CHROMED ADHESIVE WEIGHT 60 gr - MASSE À COLLER CHROMÉE 60 gr</b>		
Codice Code Code	Grammi Grams Grammes	Pz. / scatola Pcs. / box Pcs. / boîte
3060806	5 gr x 4 + 10 gr x 4	100

		
H : 3.5 mm W : 19 mm L : 108.5 mm		
<b>BARRETTA ADESIVA DA 50 gr SLIM</b> <b>ADHESIVE WEIGHT 50 gr SLIM - MASSE À COLLER 50 gr SLIM</b>		
Codice Code Code	Grammi Grams Grammes	Pz. / scatola Pcs. / box Pcs. / boîte
3060808	5 gr x 10	100

		
H : 3.5 mm W : 15 mm L : 108.5 mm		
<b>BARRETTA ADESIVA DA 45 gr PER MOTO - ADHESIVE WEIGHT 45 gr FOR MOTORCYCLE - MASSE À COLLER 45 gr POUR MOTO</b>		
Codice Code Code	Grammi Grams Grammes	Pz. / scatola Pcs. / box Pcs. / boîte
3060810	5 gr x 6 + 2,5 gr x 6	100

Italmatic utilizza nastro biadesivo NORTON SAINT GOBAIN per la produzione dei contrappesi adesivi. Questo garantisce i massimi livelli di tenuta ed adesione del contrappeso sul cerchio.

Per massimizzare l'adesione, la superficie del cerchio va opportunamente pulita da sporco, grasso, sapone e strati oleosi con un solvente.

Rimuovere il liner blu appena prima l'applicazione sulla superficie del cerchio e premere decisamente per assicurare contatto totale.

Se si desidera una maggiore adesione, si suggerisce l'impiego del Tire-R-Bond Adhesion Promoter della Norton Saint Gobain (codici 3060900A e 3060900B).

*Italmatic uses NORTON SAINT GOBAIN adhesive tape for all stick-on balancing weights.*

*This ensure top performances and perfect adherence of the weight to the rim.*

*For maximum adhesive performance, prepare the contact surface by removing dirt, wax, soap, and oily films with a cleaning solvent.*

*Remove the liner just prior to bonding surfaces together and apply firm pressure to ensure full contact.*

*If added adhesion is desired, it is recommended the use of Norton Saint Gobain Tire-R-Bond Adhesion Promoter (codes 3060900A and 3060900B).*

*Italmatic utilise ruban bi-adhésif NORTON SAINT GOBAIN pour la production des masses adhésives. Cela assure les niveaux maxima de tenue et adhésion de la masse sur la jante.*

*Afin de maximiser l'adhésion, la surface de la jante doit être opportunément nettoyée de saleté, graisse, savon et couches huileuses par un solvant.*

*Enlever le liner bleu juste avant l'application sur la surface de la jante et presser avec décision pour assurer un contact total.*

*Si on désire une adhésion majeure, on suggère l'emploi du Tire-R-Bond Adhesion Promoter de la société Norton Saint Gobain (réf. 3060900A et 3060900B).*

# CONTRAPPESI DI BILANCIATURA IN PIOMBO

LEAD BALANCING WEIGHTS

MASSES D'ÉQUILIBRAGE EN PLOMB

italmatic



H : 7 mm  
W : 11 mm  
L : 105 mm

**BARRETTA ADESIVA 50 gr PER MOTO - ADHESIVE WEIGHT 50 gr FOR MOTORCYCLE - MASSE À COLLER 50 gr POUR MOTO**

Codice Code Code	Grammi Grams Grammes	Pz. / scatola Pcs. / box Pcs. / boîte
3060811	5 gr x 7 + 2,5 gr x 6	100



H : 7 mm  
W : 11 mm  
L : 105 mm

**BARRETTA ADESIVA 50 gr PER MOTO NERA - ADHESIVE WEIGHT 50 gr FOR MOTORCYCLE BLACK - MASSE À COLLER 50 gr POUR MOTO NOIRE**

Codice Code Code	Grammi Grams Grammes	Pz. / scatola Pcs. / box Pcs. / boîte
3060811B	5 gr x 7 + 2,5 gr x 6	100



H : 7 mm  
W : 11 mm  
L : 105 mm

**BARRETTA ADESIVA 50 gr MOTO CROMATA - ADHESIVE WEIGHT 50 gr MOTORCYCLE CHROMED - MASSE À COLLER 50 gr MOTO CHROMÉE**

Codice Code Code	Grammi Grams Grammes	Pz. / scatola Pcs. / box Pcs. / boîte
3060811C	5 gr x 7 + 2,5 gr x 6	100



H : 8 mm  
W : 15 mm  
L : 108.5 mm

**BARRETTA ADESIVA DA 100 gr  
ADHESIVE WEIGHT 100 gr - MASSE À COLLER 100 gr**

Codice Code Code	Grammi Grams Grammes	Pz. / scatola Pcs. / box Pcs. / boîte
3060812	20 gr x 5	25



H : 6 mm  
W : 19 mm  
L : 109 mm

**BARRETTA ADESIVA DA 100 gr  
ADHESIVE WEIGHT 100 gr - MASSE À COLLER 100 gr**

Codice Code Code	Grammi Grams Grammes	Pz. / scatola Pcs. / box Pcs. / boîte
3060814	25 gr x 4	25



3060827

**MOD. A.L.A.**

Contrappesi adesivi per cerchi in lega autocarro  
Adhesive weights for truck alloy rims  
Masses à coller pour jantes en alliage camion

Codice Code Code	Grammi Grams Grammes	Pz. / scatola Pcs. / box Pcs. / boîte
3060825	50	10
3060826	75	10
3060827	100	10
3060828	125	10
3060829	150	10
3060830	175	10
3060831	200	10
3060832	250	10
3060833	300	10



H : 9 mm  
W : 25 mm  
L : 108 mm

**BARRETTA ADESIVA DA 200 gr  
ADHESIVE WEIGHT 200 gr  
MASSE À COLLER 200 gr**

Codice Code Code	Grammi Grams Grammes	Pz. / scatola Pcs. / box Pcs. / boîte
3060820	50 gr x 4	25

Nota: altri modelli di contrappesi disponibili su richiesta.  
Note: Other balancing weights models available on request.  
Note: Autres masses d'équilibrage disponibles sur demande.

# CONTRAPPESI DI BILANCIATURA IN PIOMBO - PACKING LIST

## LEAD BALANCING WEIGHTS - PACKING LIST

### MASSES D'ÉQUILIBRAGE EN PLOMB - LISTE DE COLISAGE

#### Packing list - Mod. S/I

Grammi Grams Grammes	Pz./scatola Pcs./box Pcs./boîte	Scatole/scatolone Boxes/master box Boîtes/carton	Pz./scatolone Pcs./master box Pcs./carton	Scatoloni/bancale Master boxes/pallet Cartons/palette	Pz./bancale Pcs./pallet Pcs./palette	Pz./metà bancale Pcs./half pallet Pcs./demi-palette
5	100	20	2000	40	80000	40000
10	100	20	2000	40	80000	40000
15	100	14	1400	40	56000	28000
20	100	8	800	40	32000	16000
25	100	8	800	40	32000	16000
30	100	8	800	40	32000	16000
35	100	6	600	40	24000	12000
40	100	6	600	40	24000	12000
45	50	8	400	40	16000	8000
50	50	8	400	40	16000	8000
55	50	6	300	40	12000	6000
60	50	6	300	40	12000	6000

#### Packing list - Mod. SP - Mod. Ducato

Grammi Grams Grammes	Pz./scatola Pcs./box Pcs./boîte	Scatole/scatolone Boxes/master box Boîtes/carton	Pz./scatolone Pcs./master box Pcs./carton	Scatoloni/bancale Master boxes/pallet Cartons/palette	Pz./bancale Pcs./pallet Pcs./palette	Pz./metà bancale Pcs./half pallet Pcs./demi-palette
5	100	20	2000	40	80000	40000
10	100	14	1400	40	56000	28000
15	100	14	1400	40	56000	28000
20	100	8	800	40	32000	16000
25	100	8	800	40	32000	16000
30	100	8	800	40	32000	16000
35	100	6	600	40	24000	12000
40	100	6	600	40	24000	12000
45	50	8	400	40	16000	8000
50	50	8	400	40	16000	8000
55	50	6	300	40	12000	6000
60	50	6	300	40	12000	6000

#### Packing list Mod. T.A. - Mod. F 650

Grammi Grams Grammes	Pz./scatola Pcs./box Pcs./boîte	Scatole/scatolone Boxes/master box Boîtes/carton	Pz./scatolone Pcs./master box Pcs./carton	Scatoloni/bancale Master boxes/pallet Cartons/palette	Pz./bancale Pcs./pallet Pcs./palette	Pz./metà bancale Pcs./half pallet Pcs./demi-palette
50	50	8	400	40	16000	8000
75	50	8	400	40	16000	8000
100	50	6	300	40	12000	6000
150	25	8	200	40	8000	4000
200	25	6	150	40	6000	3000
250	25	5	125	40	5000	2500
300	20	5	100	40	4000	2000
350	10	6	60	40	2400	1200
400	10	6	60	40	2400	1200
450	10	6	60	40	2400	1200
500	10	6	60	40	2400	1200

#### Packing list adesivi - adhesives - adhésives

#### Altri modelli - Other models - Autres modèles

Barrette adesive: 45/50/60 gr. n° 200 scatole per bancale (tot. 20.000 pz.)  
Barrette adesive: 200 gr. n° 200 scatole per bancale (tot. 5.000 pz.)

Adhesive weights: 45/50/60 gr. n° 200 boxes for pallet (tot. 20.000 pcs.)  
Adhesive weights: 200 gr. n° 200 boxes for pallet (tot. 5.000 pcs.)

Masses à coller: 45/50/60 gr. n° 200 boîtes pour palette (tot. 20.000 pcs.)  
Masses à coller: 200 gr. n° 200 boîtes pour palette (tot. 5.000 pcs.)

In scatole singole

In single boxes

En boîtes individuelles

# CONTRAPPESI DI BILANCIATURA SENZA PIOMBO

NO LEAD BALANCING WEIGHTS

MASSES D'ÉQUILIBRAGE SANS PLOMB

italmatic



3090205P

## MOD. S/1 PLASTIC

Contrappesi universali in zinco plastificati per cerchi in acciaio.  
Zinc plastic coated universal balancing weights for steel rims.  
Masse d'équilibrage universelles en zinc plastifiées pour jantes en acier.

Codice Code Code	Grammi Grams Grammes	Pz. / scatola Pcs. / box Pcs. / boîte
3090201P	5	100
3090202P	10	100
3090203P	15	100
3090204P	20	100
3090205P	25	100
3090206P	30	100
3090207P	35	50
3090208P	40	50
3090209P	45	50
3090210P	50	50
3090211P	55	50
3090212P	60	50
3090214P	70	50
3090216P	80	50
3090218P	90	25
3090220P	100	25



3090205Z

## MOD. S/1 O.E.M.

Contrappesi universali in zinco per cerchi in acciaio - Rivestimento O.E.M.  
Zinc universal balancing weights for steel rims - O.E.M. coating  
Masse d'équilibrage universelles en zinc pour jantes en acier - Habillage O.E.M.

Codice Code Code	Grammi Grams Grammes	Pz. / scatola Pcs. / box Pcs. / boîte
3090201Z	5	100
3090202Z	10	100
3090203Z	15	100
3090204Z	20	100
3090205Z	25	100
3090206Z	30	100
3090207Z	35	50
3090208Z	40	50
3090209Z	45	50
3090210Z	50	50
3090211Z	55	50
3090212Z	60	50
3090214Z	70	50
3090216Z	80	50
3090218Z	90	25
3090220Z	100	25



3090304Z

## MOD. D/1 O.E.M.

Contrappesi universali in zinco per cerchi in acciaio - Rivestimento O.E.M.  
Zinc universal balancing weights for steel rims - O.E.M. coating  
Masse d'équilibrage universelles en zinc pour jantes en acier - Habillage O.E.M.

Codice Code Code	Grammi Grams Grammes	Pz. / scatola Pcs. / box Pcs. / boîte
3090231Z	5	100
3090232Z	10	100
3090233Z	15	100
3090234Z	20	100
3090235Z	25	100
3090236Z	30	100
3090237Z	35	50
3090238Z	40	50
3090239Z	45	50
3090240Z	50	50
3090241Z	55	50
3090242Z	60	50



3090705

## MOD. S/2 UNCOATED

Contrappesi universali in zinco per cerchi in acciaio non rivestiti con gobbeta.  
Universal zinc weights for steel rims cam-backed uncoated.  
Masse d'équilibrage universelles en zinc pour jantes en acier sans habillage avec bosse.

Codice Code Code	Grammi Grams Grammes	Pz. / scatola Pcs. / box Pcs. / boîte
3090701	5	100
3090702	10	100
3090703	15	100
3090704	20	100
3090705	25	100
3090706	30	100
3090707	35	50
3090708	40	50
3090709	45	50
3090710	50	50
3090711	55	50
3090712	60	50



# CONTRAPPESI DI BILANCIATURA SENZA PIOMBO

NO LEAD BALANCING WEIGHTS

MASSES D'ÉQUILIBRAGE SANS PLOMB



3090405P

## MOD. SP PLASTIC

Contrappesi universali in zinco plastificati per cerchi in lega.  
*Zinc plastic coated universal balancing weights for alloy rims.*  
*Masses d'équilibrage universelles plastifiées en zinc pour jantes en alliage.*

Codice Code Code	Grammi Grams Grammes	Pz. / scatola Pcs. / box Pcs. / boîte
3090401P	5	100
3090402P	10	100
3090403P	15	100
3090404P	20	100
3090405P	25	100
3090406P	30	100
3090407P	35	50
3090408P	40	50
3090409P	45	50
3090410P	50	50
3090411P	55	50
3090412P	60	50



3090754Z

## MOD. ST O.E.M.

Contrappesi universali in zinco per cerchi in lega - Rivestimento O.E.M.  
*Zinc universal balancing weights for alloy rims - O.E.M. coating*  
*Masses d'équilibrage universelles en zinc pour jantes en alliage - Habillage O.E.M.*

Codice Code Code	Grammi Grams Grammes	Pz. / scatola Pcs. / box Pcs. / boîte
3090751Z	5	100
3090752Z	10	100
3090753Z	15	100
3090754Z	20	100
3090755Z	25	100
3090756Z	30	100
3090757Z	35	50
3090758Z	40	50
3090759Z	45	50
3090760Z	50	50
3090761Z	55	50
3090762Z	60	50



3090754

## MOD. ST UNCOATED

Contrappesi universali in zinco per cerchi in lega non rivestiti.  
*Zinc universal balancing weights for alloy rims uncoated.*  
*Masses d'équilibrage universelles en zinc pour jantes en alliage sans habillage.*

Codice Code Code	Grammi Grams Grammes	Pz. / scatola Pcs. / box Pcs. / boîte
3090751	5	100
3090752	10	100
3090753	15	100
3090754	20	100
3090755	25	100
3090756	30	100
3090757	35	50
3090758	40	50
3090759	45	50
3090760	50	50
3090761	55	50
3090762	60	50



3090305P

## MOD. F PLASTIC

Contrappesi speciali in zinco plastificati per cerchi in acciaio francesi.  
*Zinc plastic coated special balancing weights for French steel rims.*  
*Masses d'équilibrage spéciales plastifiées en zinc pour jantes en acier françaises.*

Codice Code Code	Grammi Grams Grammes	Pz. / scatola Pcs. / box Pcs. / boîte
3090301P	5	100
3090302P	10	100
3090303P	15	100
3090304P	20	100
3090305P	25	100
3090306P	30	100
3090307P	35	50
3090308P	40	50
3090309P	45	50
3090310P	50	50
3090311P	55	50
3090312P	60	50

I pesi in zinco rivestiti Italmatic sono disponibili in due tipologie, entrambe approvate da primarie case automobilistiche (OEM) in quanto soddisfano lo standard di almeno 500 ore di resistenza nel test di nebbia salina:

- Classico rivestimento con plastificazione (superficie epossidica chiusa)

- Nuovo rivestimento O.E.M.

In alternativa, per il solo mercato del ricambio, è disponibile una linea di pesi in zinco non rivestiti.

*Italmatic zinc coated weights are available with two types, both approved by primary car industries (OEM) as they satisfy the standard of at least 500 hours resistance in salt spray test:*

*-Classic coating with plastic (hepossidic closed surface)*

*-New O.E.M. coating.*

*In alternative, only for the available after market, a line of uncoated zinc weights is proposed.*

*Les masses Italmatic en zinc habillée sont disponibles avec deux types d'habillage, les deux approuvés par des industries primaires de fabrication voitures (OEM) puisqu'elles satisfont le standard d'au moins 500 heures de résistance au test en brouillard salin:*

*-Habillage classique avec plastification (surface hépossidique fermée)*

*-Nouvel habillage O.E.M.*

*En alternative, seulement pour le marché du rechange, une ligne de masses en zinc non habillées est disponible.*

# CONTRAPPESI DI BILANCIATURA SENZA PIOMBO

NO LEAD BALANCING WEIGHTS

MASSSES D'ÉQUILIBRAGE SANS PLOMB

italmatic



3090605P

## MOD. J PLASTIC

Contrappesi speciali in zinco plastificati per cerchi in lega auto giapponesi.  
Zinc plastic coated special balancing weights for alloy rims of Japanese cars.  
Masses d'équilibrage spéciales plastifiées en zinc pour jantes en alliage des voitures japonaises.

Codice Code Code	Grammi Grams Grammes	Pz. / scatola Pcs. / box Pcs. / boîte
3090601P	5	100
3090602P	10	100
3090603P	15	100
3090604P	20	100
3090605P	25	100
3090606P	30	100
3090607P	35	50
3090608P	40	50
3090609P	45	50
3090610P	50	50
3090611P	55	50
3090612P	60	50



3091305P

## MOD. M.S. MC PLASTIC (\*)

Contrappesi in zinco plastificati con molla staccata per Mercedes-Chrysler  
Zinc plastic coated balancing weights with detached clip for Mercedes-Chrysler  
Masses en zinc plastifiées avec clip détaché pour Mercedes-Chrysler

Codice Code Code	Grammi Grams Grammes	Pz. / scatola Pcs. / box Pcs. / boîte
3091302P	10	100
3091303P	15	100
3091304P	20	100
3091305P	25	100
3091306P	30	100
3091307P	35	50
3091308P	40	50
3091309P	45	50
3091310P	50	50
3091311P	55	50
3091312P	60	50
3091320	Clip MC1 zincata/zinc coated/zingué	100
3091325	Clip MC2 plastificata/plastic coated/plastifié	100

\* Le scatole dei pesi F M.S. contengono le molle. Le scatole dei pesi M.S. MC non contengono le molle.  
Boxes of F MS weights contain clips. Boxes of M.S.MC weights do not contain clips.  
Les boîtes des masses FMS contiennent les clips. Les boîtes des masses M.S.MC ne contiennent pas de clips.



3090520P

3090506P

## MOD. F M.S. PLASTIC (\*)

Contrappesi in zinco plastificati con molla staccata per cerchi in lega auto francesi  
Zinc plastic coated weights with detached clip for alloy rims of french cars  
Masses d'équilibrage plastifiées en zinc avec clip détaché pour jantes en alliage des voitures françaises

Codice Code Code	Grammi Grams Grammes	Pz. / scatola Pcs. / box Pcs. / boîte
3090502P	10	100
3090503P	15	100
3090504P	20	100
3090505P	25	100
3090506P	30	100
3090507P	35	50
3090508P	40	50
3090509P	45	50
3090510P	50	50
3090520P	Clip H / TR-AL	100



H : 4,0 mm  
W : 19 mm  
L : 17,50 mm

## BARRETTA ADESIVA IN ZINCO PLASTIFICATO DA 60 GR SLIM ZINC PLASTIC COATED ADHESIVE WEIGHT 60 GR. SLIM MASSE ADHÉSIVE EN ZINC PLASTIFIÉ À 60 GR SLIM

Codice Code Code	Grammi Grams Grammes	Pz. / scatola Pcs. / box Pcs. / boîte
3090879	5 gr x 12	100

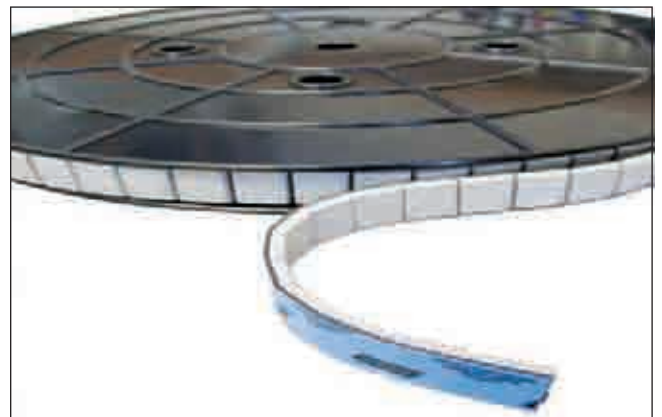

## ROTOLO ADESIVO IN ZINCO PLASTIFICATO DA 5,5 KG ADHESIVE ROLL IN PLASTIC COATED ZINC 5,5 KG ROULEAU ADHÉSIF EN ZINC PLASTIFIÉ À 5,5 KG

Codice Code Code	Grammi Grams Grammes	Pz. / scatola Pcs. / box Pcs. / boîte
3090879R	5 gr x 1100	100

# CONTRAPPESI DI BILANCIATURA SENZA PIOMBO

NO LEAD BALANCING WEIGHTS

MASSES D'ÉQUILIBRAGE SANS PLOMB



H : 4.5 mm  
W : 19 mm  
L : 102 mm

**BARRETTA ADESIVA IN ZINCO PLASTIFICATO DA 35 gr SLIM**  
ZINC PLASTIC COATED ADHESIVE WEIGHT 35 gr SLIM  
MASSE ADHÉSIVE EN ZINC PLASTIFIÉ À 35 gr SLIM

Codice Code Code	Grammi Grams Grammes	Pz. / scatola Pcs./box Pcs./boîte
3090870	5 gr x 7	100



H : 3 mm  
W : 19 mm  
L : 119 mm

**BARRETTA ADESIVA IN ZINCO PLASTIFICATO 30 gr EXTRA SLIM**  
ZINC PLASTIC COATED ADHESIVE WEIGHT 30 gr EXTRA SLIM  
MASSE ADHÉSIVE EN ZINC PLASTIFIÉ 30 gr EXTRA SLIM

Codice Code Code	Grammi Grams Grammes	Pz. / scatola Pcs./box Pcs./boîte
3090874	5 gr x 4 + 2,5 gr x 4	100



H : 6.5 mm  
W : 15 mm  
L : 106 mm

**BARRETTA ADESIVA IN ZINCO PLASTIFICATO DA 45 gr**  
ZINC PLASTIC COATED ADHESIVE WEIGHT 45 gr  
MASSE ADHÉSIVE EN ZINC PLASTIFIÉ À 45 gr

Codice Code Code	Grammi Grams Grammes	Pz. / scatola Pcs./box Pcs./boîte
3090872	10 gr x 3 + 5 gr x 3	100



3090945P

H : 3.6 mm  
W : 19 mm  
(15-60gr.)  
15 mm  
(5-10gr.)

**MOD. A.Z.B.**

Contrappesi adesivi in zinco plastificati - slim  
Plastic coated zinc adhesive weights - slim  
Masse à coller en zinc plastifiées - slim

Codice Code Code	Grammi Grams Grammes	Pz. / scatola Pcs. / box Pcs. / boîte
3090941P	5	100
3090942P	10	100
3090943P	15	100
3090944P	20	100
3090945P	25	100
3090946P	30	100
3090947P	35	50
3090948P	40	50
3090949P	45	50
3090950P	50	50
3090951P	55	50
3090952P	60	50



H : 4 mm  
W : 19 mm  
L : 125 mm

**BARRETTA ADESIVA IN ZINCO PLASTIFICATO 45 gr SLIM**  
ZINC PLASTIC COATED ADHESIVE WEIGHT 45 gr SLIM  
MASSE ADHÉSIVE EN ZINC PLASTIFIÉ 45 gr SLIM

Codice Code Code	Grammi Grams Grammes	Pz. / scatola Pcs. / box Pcs. / boîte
3090873	10 gr x 3 + 5 gr x 3	100

## Contrappesi di bilanciatura in stagno

Tin balancing weights

Masse d'équilibrage en étain



H : 4.8 mm  
W : 15 mm  
L : 108.5 mm

**BARRETTA ADESIVA IN STAGNO DA 40 gr STANDARD**  
TIN ADHESIVE WEIGHT 40 gr STANDARD  
MASSE À COLLER EN ÉTAÏN 40 gr STANDARD

Codice Code Code	Grammi Grams Grammes	Pz. / scatola Pcs. / box Pcs. / boîte
3090800	5 gr x 8	100



H : 3.8 mm  
W : 19 mm  
L : 108.5 mm

**BARRETTA ADESIVA IN STAGNO DA 40 gr SLIM**  
TIN ADHESIVE WEIGHT 40 gr SLIM  
MASSE À COLLER EN ÉTAÏN 40 gr SLIM

Codice Code Code	Grammi Grams Grammes	Pz. / scatola Pcs. / box Pcs. / boîte
3090802	5 gr x 8	100

# CONTRAPPESI DI BILANCIATURA SENZA PIOMBO

NO LEAD BALANCING WEIGHTS

MASSES D'ÉQUILIBRAGE SANS PLOMB

italmatic

## Contrappesi di bilanciatura in ferro

Steel balancing weights

Masses d'équilibrage en acier



3095205F

### MOD. S/1 FE\*

Contrappesi universali in ferro per cerchi di acciaio.  
Steel universal balancing weights for steel rims.  
Masses d'équilibrage universelles en acier pour jantes en acier.

Codice Code Code	Grammi Grams Grammes	Pz. / scatola Pcs. / box Pcs. / boîte
3095201F	5	100
3095202F	10	100
3095203F	15	100
3095204F	20	100
3095205F	25	100
3095206F	30	100
3095207F	35	50
3095208F	40	50
3095209F	45	50
3095210F	50	50



3095405F

### MOD. SP FE\*

Contrappesi universali in ferro per cerchi in lega.  
Steel universal balancing weights for alloy rims.  
Masses d'équilibrage universelles en acier pour jantes en alliage.

Codice Code Code	Grammi Grams Grammes	Pz. / scatola Pcs. / box Pcs. / boîte
3095401F	5	100
3095402F	10	100
3095403F	15	100
3095404F	20	100
3095405F	25	100
3095406F	30	100
3095407F	35	50
3095408F	40	50
3095409F	45	50
3095410F	50	50



H : 3.6 mm  
W : 19 mm  
L : 150 mm

**BARRETTA ADESIVA IN FERRO ZINCATO DA 60 gr SLIM**  
ZINC PLATED STEEL ADHESIVE WEIGHT 60 gr SLIM  
MASSE ADHÉSIVE EN ACIER ZINGUÉ À 60 gr SLIM

Codice Code Code	Grammi Grams Grammes	Pz. / scatola Pcs. / box Pcs. / boîte
3090882	5 gr x 12	100



H : 3.6 mm  
W : 19 mm  
L : 148 mm

**BARRETTA ADESIVA IN FERRO ZINCATO DA 60 gr SLIM**  
ZINC PLATED STEEL ADHESIVE WEIGHT 60 gr SLIM  
MASSE ADHÉSIVE EN ACIER ZINGUÉ À 60 gr SLIM

Codice Code Code	Grammi Grams Grammes	Pz. / scatola Pcs. / box Pcs. / boîte
3090883	5 gr x 4 + 10gr x 4	100



H : 3.6 mm  
W : 19 mm  
L : 150 mm

**BARRETTA ADESIVA IN FERRO DA 60 gr SLIM - RIVESTIMENTO O.E.M.**  
STEEL ADHESIVE WEIGHT 60 gr SLIM - O.E.M. COATING  
MASSE ADHÉSIVE EN ACIER À 60 gr SLIM - HABILLAGE O.E.M.

Codice Code Code	Grammi Grams Grammes	Pz. / scatola Pcs. / box Pcs. / boîte
3090882Z	5 gr x 12	100

\* Gli innovativi pesi in ferro a clip Italmatic prodotti in Italia, sono patent pending e caratterizzati da elevati standard qualitativi per garantire la massima tenuta sui cerchi europei sia in ferro che in lega.

Soddisfano la normativa EU 200/53/CEE e sono rivestiti con trattamento anti-corrosivo.

\* The innovative Italmatic clip steel weights produced in Italy are patent pending and distinguished by high quality standards to assure the max. sealing on both steel and alloy European rims.

They satisfy EU 200/53/CEE rules and are coated by anti-corrosion treatment.

\* Les masses innovantes Italmatic clip en acier produites en Italie, sont patent pending et caractérisées par des hauts standards de qualité afin d'assurer l'étanchéité max. sur les jantes Européennes soit en acier soit en alliage. Elles satisfont la règle EU 200/53/CEE et elles sont revêtues par traitement anticorrosion.

**CONTRAPPESI DI BILANCIATURA SENZA PIOMBO**  
**NO LEAD BALANCING WEIGHTS**  
**MASSES D'ÉQUILIBRAGE SANS PLOMB**



3090882R

**BARRETTA ADESIVA IN FERRO SLIM IN ROTOLI DA 6 Kg**  
**STEEL ADHESIVE WEIGHT SLIM IN ROLLS OF 6 Kg**  
**MASSE ADHÉSIVE EN ACIER SLIM EN ROULEAUX À 6 Kg**

Codice Code Code	Grammi Grams Grammes	Pz. / scatola Pcs. / box Pcs. / boîte
3090882R	5 gr x 1200	100



3095946F

H : 36 mm  
W : 19 mm

**MOD. A.F.B.**

Contrappesi adesivi zincati in ferro - Slim pretagliati  
 Steel zinc coated adhesive weights - Slim pre-cut  
 Masses adhésives en acier zinguées - Slim pré-coupées

Codice Code Code	Grammi Grams Grammes	Pz. / scatola Pcs. / box Pcs. / boîte
3095941F	5	1200
3095942F	10	600
3095943F	15	400
3095944F	20	300
3095945F	25	200
3095946F	30	200
3095947F	35	100
3095948F	40	100
3095949F	45	100
3095950F	50	100
3095951F	55	100
3095952F	60	100
3095953F	65	84
3095954F	70	84
3095955F	75	84
3095956F	80	84

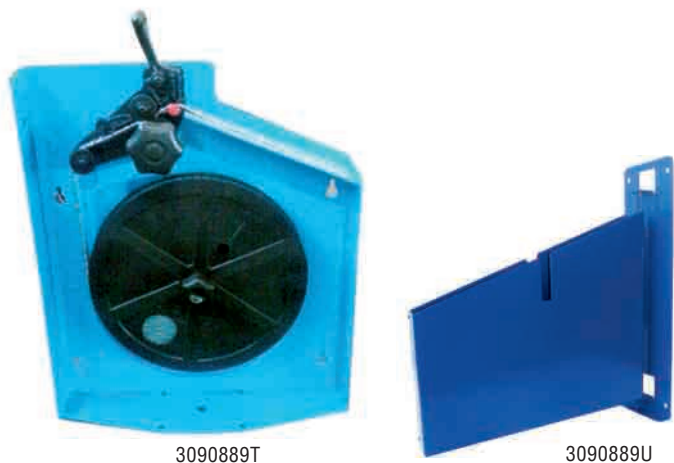

**Supporti per rotoli adesivi**  
**Supports for adhesive rolls**  
**Supports pour rouleaux adhésifs**

Codice Code Code	Descrizione Description Description
3090889T	Supporto a parete per rotolo in ferro (cod 3090882R) con dispositivo di taglio Wall support for steel adhesive roll (code 3090882R) with cutting device Support mural pour rouleau adhésif en acier (code 3090882R) avec dispositif de coupe
3090889TS	Supporto a pavimento con dispositivo di taglio per rotolo adesivo in ferro 6kg (cod. 3090882R) Floor stand with cutting device for steel adhesive roll 6kg (code 3090882R) Support au sol avec dispositif de coupe pour rouleau adhésif en acier 6kg (code 3090882R)
3090889P	Piedistallo per 3090889T Floor stand for 3090889T Support au sol pour 3090889T
3090889U	Supporto a parete economico per rotolo in ferro (cod 3090882R) Cheap wall support for steel adhesive roll (code 3090882R) Support mural économique pour rouleau adhésif en acier (code 3090882R) avec dispositif de coupe



# CONTRAPPESI DI BILANCIATURA SENZA PIOMBO

NO LEAD BALANCING WEIGHTS

MASSES D'ÉQUILIBRAGE SANS PLOMB

italmatic



H : 4.0 mm  
W : 19 mm  
L : 140 mm

**BARRETTA ADESIVA IN FERRO PLASTIFICATA ANTRACITE 60GR SLIM**  
ANTHRACITE PLASTIC COATED STEEL ADHESIVE WEIGHT 60GR SLIM  
MASSE ADHÉSIVE EN ACIER PLASTIFIÉ ANTHRACITE À 60GR SLIM

Codice Code Code	Grammi Grams Grammes	Pz. / scatola Pcs. / box Pcs. / boîte
3090882A	5 gr x 12	100
3090883A	5 gr x 4 + 10 gr x 4	100



H : 4.0 mm  
W : 19 mm  
L : 140 mm

**BARRETTA ADESIVA IN FERRO PLASTIFICATA NERA 60GR SLIM**  
BLACK PLASTIC COATED STEEL ADHESIVE WEIGHT 60GR SLIM  
MASSE ADHÉSIVE EN ACIER PLASTIFIÉ NOIR À 60GR SLIM

Codice Code Code	Grammi Grams Grammes	Pz. / scatola Pcs. / box Pcs. / boîte
3090882B	5 gr x 12	100
3090883B	5 gr x 4 + 10 gr x 4	100



H : 4.0 mm  
W : 19 mm  
L : 140 mm

**BARRETTA ADESIVA IN FERRO PLASTIFICATA GRIGIA 60GR SLIM**  
GREY PLASTIC COATED STEEL ADHESIVE WEIGHT 60GR SLIM  
MASSE ADHÉSIVE EN ACIER PLASTIFIÉ GRIS À 60GR SLIM

Codice Code Code	Grammi Grams Grammes	Pz. / scatola Pcs. / box Pcs. / boîte
3090882G	5 gr x 12	100
3090883G	5 gr x 4 + 10 gr x 4	100



H : 4.0 mm  
W : 19 mm  
L : 140 mm

**BARRETTA ADESIVA IN FERRO PLASTIFICATA BIANCA 60GR SLIM**  
WHITE PLASTIC COATED STEEL ADHESIVE WEIGHT 60GR SLIM  
MASSE ADHÉSIVE EN ACIER PLASTIFIÉ BLANC À 60GR SLIM

Codice Code Code	Grammi Grams Grammes	Pz. / scatola Pcs. / box Pcs. / boîte
3090882W	5 gr x 12	100
3090883W	5 gr x 4 + 10 gr x 4	100



H : 2.0 mm  
W : 19 mm  
L : 142 mm

**BARRETTA ADESIVA IN FERRO ZINCATO 30GR EXTRA SLIM**  
ZINC PLATED STEEL ADHESIVE WEIGHT 30GR EXTRA SLIM  
MASSE ADHÉSIVE EN ACIER ZINGUÉ À 30GR EXTRA SLIM

Codice Code Code	Grammi Grams Grammes	Pz. / scatola Pcs. / box Pcs. / boîte
3090885	2,5 gr x 12	100



H : 2.2 mm  
W : 19 mm  
L : 142 mm

**BARRETTA ADESIVA IN FERRO NERA 30GR EXTRA SLIM**  
BLACK PLASTIC COATED STEEL ADHESIVE WEIGHT 30GR EXTRA SLIM  
MASSE ADHÉSIVE EN ACIER NOIR À 30GR EXTRA SLIM

Codice Code Code	Grammi Grams Grammes	Pz. / scatola Pcs. / box Pcs. / boîte
3090885B	2,5 gr x 12	100



H : 2.2 mm  
W : 19 mm  
L : 142 mm

**BARRETTA ADESIVA IN FERRO PLASTIFICATA GRIGIA 30GR EXTRA SLIM**  
GREY COATED STEEL ADHESIVE WEIGHT 30GR EXTRA SLIM  
MASSE ADHÉSIVE EN ACIER PLASTIFIÉ GRIS À 30GR EXTRA SLIM

Codice Code Code	Grammi Grams Grammes	Pz. / scatola Pcs. / box Pcs. / boîte
3090885G	2,5 gr x 12	100



H : 6.0 mm  
W : 25 mm  
L : 132 mm

**BARRETTA ADESIVA IN FERRO ZINCATO 120GR**  
ZINC PLATED STEEL ADHESIVE WEIGHT 120GR  
MASSE ADHÉSIVE EN ACIER ZINGUÉ À 120gr

Codice Code Code	Grammi Grams Grammes	Pz. / scatola Pcs. / box Pcs. / boîte
3090886	10 gr x 12	50



H : 6.2 mm  
W : 25 mm  
L : 132 mm

**BARRETTA ADESIVA IN FERRO PLASTIFICATA GRIGIA 120GR**  
GREY COATED STEEL ADHESIVE WEIGHT 120GR  
MASSE ADHÉSIVE EN ACIER PLASTIFIÉ GRIS À 120GR

Codice Code Code	Grammi Grams Grammes	Pz. / scatola Pcs. / box Pcs. / boîte
3090886G	10 gr x 12	50

# CONTRAPPESI DI BILANCIATURA SENZA PIOMBO - PACKING LIST

## NO LEAD BALANCING WEIGHTS - PACKING LIST

### MASSES D'ÉQUILIBRAGE SANS PLOMB - LISTE DE COLISAGE

#### MOD. S/I - D/I

Grammi Grams Grammes	Pz./scatola Pcs./box Pcs./boîte	Scatole/scatolone Boxes/master box Boîtes/carton	Scatoloni/bancale Master boxes/pallet Cartons/palette	Pz./bancale Pcs./pallet Pcs./palette
5	100	20	40	80000
10	100	14	40	56000
15	100	14	40	56000
20	100	8	40	32000
25	100	8	40	32000
30	100	8	40	32000
35	50	8	40	16000
40	50	8	40	16000
45	50	8	40	16000
50	50	8	40	16000
55	50	6	40	12000
60	50	6	40	12000

#### MOD. S/2

Grammi Grams Grammes	Pz./scatola Pcs./box Pcs./boîte	Scatole/scatolone Boxes/master box Boîtes/carton	Scatoloni/bancale Master boxes/pallet Cartons/palette	Pz./bancale Pcs./pallet Pcs./palette
5	100	20	40	80000
10	100	14	40	56000
15	100	14	40	56000
20	100	8	40	32000
25	100	8	40	32000
30	100	6	40	24000
35	50	8	40	16000
40	50	8	40	16000
45	50	6	40	12000
50	50	6	40	12000
55	50	6	40	12000
60	50	6	40	12000

#### MOD. SP

Grammi Grams Grammes	Pz./scatola Pcs./box Pcs./boîte	Scatole/scatolone Boxes/master box Boîtes/carton	Scatoloni/bancale Master boxes/pallet Cartons/palette	Pz./bancale Pcs./pallet Pcs./palette
5	100	20	40	80000
10	100	14	40	56000
15	100	8	40	32000
20	100	8	40	32000
25	100	8	40	32000
30	100	8	40	32000
35	50	6	40	12000
40	50	6	40	12000
45	50	8	40	16000
50	50	8	40	16000
55	50	6	40	12000
60	50	6	40	12000

#### MOD. ST

Grammi Grams Grammes	Pz./scatola Pcs./box Pcs./boîte	Scatole/scatolone Boxes/master box Boîtes/carton	Scatoloni/bancale Master boxes/pallet Cartons/palette	Pz./bancale Pcs./pallet Pcs./palette
5	100	20	40	80000
10	100	14	40	56000
15	100	8	40	32000
20	100	8	40	32000
25	100	8	40	32000
30	100	6	40	24000
35	50	8	40	16000
40	50	8	40	16000
45	50	6	40	12000
50	50	6	40	12000
55	50	6	40	12000
60	50	6	40	12000

#### Barrette adesive in ferro 60gr Steel adhesive weights 60gr Masses adhésives en acier 60gr

Grammi Grams Grammes	Pz./scatola Pcs./box Pcs./boîte	Scatole/scatolone Boxes/master box Boîtes/carton	Scatoloni/bancale Master boxes/pallet Cartons/palette	Pz./bancale Pcs./pallet Pcs./palette
3090870	100	-	-	20000
3090872	100	-	-	20000
3090873	100	-	-	20000
3090874	100	-	-	20000
3090800	100	-	-	20000
3090802	100	-	-	20000
3090882	100	-	-	20000
3090882R	1	-	-	60
3090883	100	-	-	20000

#### MOD. S/I FE

Grammi Grams Grammes	Pz./scatola Pcs./box Pcs./boîte	Scatole/scatolone Boxes/master box Boîtes/carton	Scatoloni/bancale Master boxes/pallet Cartons/palette	Pz./bancale Pcs./pallet Pcs./palette
5	100	14	40	56000
10	100	14	40	56000
15	100	14	40	56000
20	100	8	40	32000
25	100	8	40	32000
30	100	6	40	24000
35	50	8	40	16000
40	50	8	40	16000
45	50	8	40	16000
50	50	8	40	16000

#### MOD. SP FE

Grammi Grams Grammes	Pz./scatola Pcs./box Pcs./boîte	Scatole/scatolone Boxes/master box Boîtes/carton	Scatoloni/bancale Master boxes/pallet Cartons/palette	Pz./bancale Pcs./pallet Pcs./palette
5	100	14	40	56000
10	100	14	40	56000
15	100	14	40	56000
20	100	8	40	32000
25	100	8	40	32000
30	100	6	40	24000
35	50	6	40	12000
40	50	6	40	12000
45	50	8	40	16000
50	50	8	40	16000

#### Altri contrappesi in zinco Other zinc weights D'autres masses en zinc

MOD. FM.S.	Forniti in scatole singole
MOD. M.S. MC	Supplied in single boxes
MOD. A.Z.B./AFB	Fournies en boîtes individuelles

- Il tipo di rivestimento non modifica il packing list
- The type of coating doesn't change the packing list
- Le type d'habillage ne change pas la liste de colisage

# SISTEMA DI BILANCIATURA ECOLOGICO CON MICROSFERE

## ECOLOGIC BALANCING SYSTEM WITH MICROBEADS

### SYSTÈME D'ÉQUILIBRAGE AVEC MICROSPHÈRES ÉCOLOGIQUE

italmatic

Codice Code Code	Descrizione Description Description	Confezione Box Conditionnement
3110100A	Microsfere per bilanciatura pneumatici autocarro, bus, van <i>Truck tyre balancing microbeads</i> <i>Microsphères pour équilibrage pneus camion, bus, camionnette</i>	7,5 kg



3110100A

#### SISTEMA DI BILANCIATURA ECOLOGICO CON MICROSFERE

Il nuovo sistema di bilanciatura con microsfere per pneumatici camion consente la riduzione dei tempi di equilibratura, garantisce un eccellente effetto bilanciante ed una eccezionale durata nel tempo (riutilizzabile anche dopo la ricostruzione / riscalpatura del pneumatico).

Il sistema funziona grazie alla forza centrifuga indotta dalla rotazione del pneumatico che distribuisce automaticamente le microsfere in modo omogeneo all'interno del pneumatico nella direzione opposta alle sollecitazioni ricevute, annullandone gli effetti.

La composizione delle microsfere è appositamente studiata per garantire l'indispensabile elevata capacità di scivolamento all'interno del pneumatico, mantenendole asciutte e prive di cariche elettrostatiche che potrebbero ostacolarne il movimento.

Il sistema è estremamente facile da utilizzare: un misurino in dotazione consente di introdurre nel pneumatico la corretta quantità di microsfere prima di montarlo sul cerchio.

Resiste con temperature fino a 960°C ed è compatibile con TPMS.

Un misurino contiene 100 gr di prodotto

#### FUNZIONAMENTO / WORKING / FONCTIONNEMENT

**CERCHIO E PNEUMATICO PERFETTAMENTE UNIFORMI**  
Le microsfere sono distribuite uniformemente all'interno del pneumatico.

**PERFECTLY UNIFORM TIRE AND RIM**  
Microbeads are spread evenly around interior of the tire.

**JANTE ET PNEU PARFAITEMENT UNIFORMES**  
Les microsphères sont distribuées uniformément à l'intérieur du pneu.

**PNEUMATICO CON VARIAZIONE FORZA RADIALE O GROSSO DIFETTO**  
Quando un grosso difetto tira il pneumatico verso l'esterno, le microsfere si muovono nella direzione opposta, generando una forza di compensazione.

**TIRE WITH RADIAL FORCE VARIATION OR HEAVY SPOT**  
As heavy spot pulls tire outwards, microbeads move in opposite direction, creating compensating force.

**PNEU AVEC VARIATION DE LA FORCE RADIALE OU AVEC UN GROS DÉFAUT**  
Quand un gros défaut tire le pneu vers l'extérieur, les microsphères bougent en la direction opposée, en engendrant une force de compensation.

### Quantità raccomandate - Recommended quantities - Quantités recommandées

<b>40-profile</b>			<b>65-profile</b>											
445/40	R22,5	500g	205/65	R17,5	100g	265/70	R22,5	300g	275/80	R22,5	300g	12	R22,5	350g
<b>45-profile</b>			245/65	R19,5	200g	275/70	R22,5	300g	295/80	R22,5	350g	13	R20	350g
355/45	R17,5	350g	385/65	R19,5	500g	305/70	R22,5	300g	315/80	R22,5	500g	9	R22,5	300g
445/45	R19,5	500g	445/65	R19,5	500g	315/70	R22,5	300g	6,50	R17	100g	10	R22,5	300g
415/45	R22,5	500g	385/65	R22,5	500g	365/70	R22,5	350g	7,50	R17	100g	11	R22,5	300g
435/45	R22,5	500g	425/65	R22,5	500g	445/70	R24	600g	8,25	R17	100g	12	R22,5	350g
455/45	R22,5	500g	445/65	R22,5	500g	495/70	R24	600g	8	R17,5	100g	13	R22,5	500g
495/45	R22,5	500g	525/65	R20,5	500g	<b>75-profile</b>			8,50	R17,5	200g	15	R22,5	600g
<b>50-profile</b>			615/65	R20,5	600g	205/75	R17,5	100g	9	R17,5	200g	16,5	R22,5	600g
435/50	R19,5	500g	<b>70-profile</b>			215/75	R17,5	100g	9,50	R17,5	200g	18	R22,5	600g
355/50	R22,5	500g	119/70	R17,5	100g	225/75	R17,5	200g	10	R17,5	200g	11	R24	350g
435/50	R22,5	600g	215/70	R17,5	100g	235/75	R17,5	200g	11	R17,5	200g	12	R24	500g
445/50	R22,5	500g	235/70	R17,5	100g	245/75	R17,5	200g	8	R19,5	200g	14	R24	600g
<b>55-profile</b>			245/70	R17,5	200g	295/75	R22,5	300g	9	R19,5	300g	11	R24,5	350g
385/55	R19,5	500g	265/70	R17,5	200g	315/75	R22,5	300g	10	R19,5	350g	12	R24,5	500g
425/55	R19,5	500g	225/70	R19,5	200g	345/75	R22,5	350g	7,5	R20	200g			
385/55	R22,5	500g	245/70	R19,5	200g	350/75	R22,5	350g	8,25	R20	200g			
455/55	R22,5	600g	265/70	R19,5	300g	445/75	R22,5	600g	9	R20	300g			
<b>60-profile</b>			275/70	R19,5	300g	285/75	R24,5	300g	10	R20	300g			
265/60	R22,5	300g	245/70	R19,5	300g	305/75	R24,5	350g	11	R20	350g			
285/60	R22,5	300g	285/70	R19,5	300g	315/75	R24,5	500g	12	R20	350g			
295/60	R22,5	300g	305/70	R19,5	350g	<b>80-profile</b>			13	R20	350g			
305/60	R22,5	350g	605/70	R20,5	500g	205/80	R17,5	100g	9	R22,5	300g			
315/60	R22,5	350g	235/70	R22,5	200g	225/80	R17,5	100g	10	R22,5	300g			
			255/70	R22,5	300g	275/80	R22,5	300g	11	R22,5	300g			



# SISTEMA DI BILANCIATURA ECOLOGICO CON MICROSFERE

## ECOLOGIC BALANCING SYSTEM WITH MICROBEADS

### SYSTÈME D'ÉQUILIBRAGE AVEC MICROSPHÈRES ÉCOLOGIQUE

Codice Code Code	Descrizione Description Description	Grammi Grams Grammes	Pz. / scatola Pcs. / box Pcs. / boîte
3110101	Microsfere di bilanciatura Easy Balance in secchiello 7,5kg Truck tyre balancing microbeads Easy Balance in drum 7,5kg Microsphères pour équilibrage Easy Balance en seau de 7,5kg	7.500gr	1
3110101C	Sacchetto Easy Balance Easy Balance bag Sachet Easy Balance	100gr	50
3110101D	Sacchetto Easy Balance Easy Balance bag Sachet Easy Balance	200gr	35
3110101E	Sacchetto Easy Balance Easy Balance bag Sachet Easy Balance	300gr	25
3110101F	Sacchetto Easy Balance Easy Balance bag Sachet Easy Balance	350gr	20
3110101G	Sacchetto Easy Balance Easy Balance bag Sachet Easy Balance	500gr	15



3110101



### Quantità raccomandate Recommended quantities Quantités recommandées



Tyre Size	Dosage
Up to 225 wide and up to R17C	100 g
Over 225 wide and up to R17C	200 g
<b>17"</b>	
6.50R17	100 g
7.30R17	200 g
8.25R17	200 g
<b>17.5"</b>	
8R17.5	200 g
8.5R17.5	200 g
9R17.5	200 g
9.5R17.5	200 g
10R17.5	300 g
11R17.5	300 g
195/70R17.5	100 g
205/65R17.5	100 g
205/75R17.5	100 g
205/80R17.5	200 g
215/70R17.5	100 g
215/75R17.5	200 g
225/75R17.5	200 g
225/80R17.5	200 g
235/70R17.5	200 g
235/75R17.5	200 g
245/70R17.5	200 g
245/75R17.5	200 g
265/70R17.5	200 g
355/45R17.5	200 g
<b>19.5"</b>	
8R19.5	200 g
9R19.5	200 g
10R19.5	300 g
225/70R19.5	200 g
245/65R19.5	200 g
245/70R19.5	200 g
265/70R19.5	200 g
275/70R19.5	200 g
285/70R19.5	200 g

Tyre Size	Dosage
<b>19.5" continued...</b>	
305/70R19.5	300 g
385/55R19.5	300 g
385/65R19.5	350 g
425/55R19.5	350 g
435/50R19.5	350 g
445/45R19.5	300 g
445/65R19.5	400 g
<b>20"</b>	
7.50R20	200 g
8.25R20	200 g
9.00R20	200 g
10.00R20	300 g
11.00R20	300 g
12.00R20	350 g
13.00R20	350 g
<b>20.5"</b>	
525/65R20.5	500 g
615/65R20.5	600 g
605/70R20.5	600 g
<b>22.5"</b>	
9R22.5	200 g
10R22.5	300 g
11R22.5	300 g
12R22.5	350 g
13R22.5	400 g
15R22.5	400 g
16.5R22.5	500 g
18R22.5	500 g
235/70R22.5	200 g
255/70R22.5	200 g
265/60R22.5	200 g
265/70R22.5	200 g
275/70R22.5	200 g
285/60R22.5	200 g
295/60R22.5	200 g
295/75R22.5	300 g
305/60R22.5	200 g
305/70R22.5	300 g

Tyre Size	Dosage
<b>22.5" continued...</b>	
315/60R22.5	300 g
315/70R22.5	300 g
315/75R22.5	300 g
345/75R22.5	350 g
355/50R22.5	300 g
365/70R22.5	350 g
375/50R22.5	300 g
385/55R22.5	300 g
385/65R22.5	350 g
415/45R22.5	300 g
425/65R22.5	400 g
435/45R22.5	300 g
435/50R22.5	350 g
445/40R22.5	300 g
445/50R22.5	350 g
445/65R22.5	400 g
455/45R22.5	350 g
455/55R22.5	400 g
495/45R22.5	400 g
350/75R22.5	350 g
445/75R22.5	400 g
275/80R22.5	300 g
295/80R22.5	300 g
315/80R22.5	300 g
<b>24"</b>	
11R24	300 g
12R24	350 g
14R24	400 g
445/70R24	400 g
495/70R24	500 g
<b>24.5"</b>	
11R24.5	300 g
12R24.5	350 g
285/75R24.5	300 g
305/75R24.5	300 g
315/75R24.5	300 g



3110101G

## **Introduzione alle opzioni di vulcanizzazione** **Introduction to Tire Repairing curing options** **Introduction aux options de vulcanisation**

Patch Rubber Company offre unità di riparazione destinate a tre metodi di vulcanizzazione.

- Dual Cure (vulcanizzazione chimica – senza calore – in qualunque negozio gommista);
- Heat Cure (per impianti di ricostruzione o nei sistemi di riparazione in cui è applicato il calore);
- Uncure & Clothback (per impianti di ricostruzione e sistemi di riparazione in cui è applicato calore e pressione – tipicamente in autoclave e stampi a settori).

Le unità di riparazione Uncured e Clothback richiedono calore e pressione per essere applicate nei sistemi di ricostruzione o riparazione. Queste danno l'adesione massima per sistemare meglio le grosse riparazioni complesse della sezione. Le unità di riparazione Clothback sono caratterizzate dalla mancanza di gomma legante, cosa che massimizza la durata di conservazione a magazzino. Al momento dell'utilizzo deve essere applicato uno strato sulla gomma non vulcanizzata.

Applicazione delle unità Dual Cure: con soluzione autovulcanizzante Fast Dry.

Applicazione delle unità Heat Cure, Uncured e Clothback:

- Applicare con soluzioni di riparazione con vulcanizzazione a caldo nere in sistemi di vulcanizzazione dove il calore massimo è applicato a tutte le parti dell'unità di riparazione (stampi a settori e autoclavi; con temperature di vulcanizzazione di 127°C e oltre)
- Applicare le riparazioni Heat Cure con soluzione autovulcanizzante Fast Dry in sistemi di vulcanizzazione che forniscono un calore marginale (riparazione mentre è in stampi ricostruzione e autoclavi). Le autoclavi che vulcanizzano a 100°C potrebbero non fornire una temperatura sufficiente per la vulcanizzazione completa, a meno che non si aumenti il tempo di vulcanizzazione.

Patch Rubber Company offers repair units to address three methods of vulcanizing.

- Dual Cure (chemical curing - without heat - in any tire shops);
- Heat Cure (for retread plants and repair systems where heat is applied);
- Uncured & Clothback (for retread plants and repair systems where heat and pressure are applied - typically in autoclaves and section molds).

Uncured and Clothback repair units require heat and pressure to be applied in the retread or repair system. These provide maximum adhesion to better address complex large section repairs. Clothback repair units are characterized by the lack of bonding gum, which maximizes shelf life. A layer on uncured gum must be applied at the time of use.

Application of Dual Cure units: with Fast Dry self-vulcanizing cement.

Application of Heat Cure, Uncured and Clothback units:

- Apply with black heat curing repair cements in curing systems where maximum heat is applied to all parts of the repair unit (section molds and autoclaves; with curing temperatures of 127°C and higher)
- Apply Heat Cure repairs with Fast Dry self-vulcanizing cement in curing systems that provide marginal heat (repairing while in retread molds and chambers). Chambers curing at 100°C may not provide sufficient temperature for complete vulcanization, unless curing time is increased.

Patch Rubber Company offre des unités de réparation destinées à trois méthodes de vulcanisation.

- Dual Cure (vulcanisation chimique - sans chaleur - auprès de tous négoce pneus);
- Heat Cure (dans les installations de rechapage ou dans les systèmes de réparation où la chaleur est appliquée);
- Uncure & Clothback (dans les installations de rechapage ou dans les systèmes de réparation où la chaleur et la pression sont appliquées - typiquement en autoclave et moules à secteurs).

Les unités de réparation Uncured et Clothback demandent chaleur et pression pour être appliquées dans les systèmes de rechapage ou de réparation. Celles-ci donnent l'adhésion maxima pour mieux compléter les grosses réparations complexes de la section. Les unités de réparation Clothback sont caractérisées par le manque de caoutchouc liant, chose qui maximise la durée de conservation en stock. Au moment de l'utilisation, on doit appliquer une couche sur le caoutchouc non vulcanisé.

Application des unités Dual Cure: par solution autovulcanisante Fast Dry.

Application des unités Heat Cure, Uncured et Clothback:

- Appliquer par solutions de réparation à vulcanisation à chaud noires dans systèmes de vulcanisation où la chaleur maxima est appliquée à toutes parties de l'unité de réparation (moules à secteurs et autoclaves; à températures de vulcanisation de 127°C et outre)
- Appliquer les réparations Heat Cure par solution autovulcanisante Fast Dry dans systèmes de vulcanisation qui fournissent une chaleur marginale (réparation quand elle est dans des moules rechapage et autoclaves). Les autoclaves qui vulcanisent à 100°C pourraient ne pas fournir une température suffisante pour la vulcanisation complète, à moins d'augmenter le temps de vulcanisation.

## **Linee guida per le riparazioni pneumatici** **General guidelines for tyre repairing** **Lignes guide pour la réparation des pneus**

- Applicare sempre i rappezzi dal centro verso l'esterno per evitare di intrappolare aria e causare un difetto nella riparazione.
- E' necessaria una superficie di lavoro pulita per tenere lontani gli agenti contaminanti dai materiali di riparazione.
- Non permettere alla soluzione di asciugare completamente prima di applicare la gomma o il rappezzo permette alla soluzione bagnata di generare gas e questo potrebbe causare un difetto nella riparazione.
- Non usare mai aria compressa per soffiare via detriti dalla superficie preparata. I getti d'aria contengono contaminanti come olio, umidità e lubrificanti che possono ridurre significativamente l'adesione.
- I pneumatici devono essere asciutti prima di fare qualsiasi riparazione.
- Tutte le riparazioni devono essere vulcanizzate a temperatura, tempo e pressione specifici.
- Indossare sempre protezioni per occhi ed orecchie quando si effettuano riparazioni.
- E' necessaria un'illuminazione adeguata per l'ispezione della superficie.

- Always stitch tire repair units from the center outward to avoid trapping air. Trapping air under the repair unit may cause repair failure.
- A clean work surface is required to keep contaminants away from repair materials.
- Not allowing the cement to completely dry before stitching gum or the repair unit down allows the wet cement to "gas" and may cause the repair to fail.
- Never use compressed air to blow debris from the prepared surface. Airlines contain contaminants such as oil, moisture and lubricants which can greatly reduce adhesion.
- Tires must be dry before making any repair.
- All repairs must be cured at a specific temperature, time and pressure.
- Always wear eye and ear protections when making repairs.
- An appropriate lighting is required at the surface being inspected.

- Appliquer toujours les emplâtres du centre vers l'extérieur afin d'éviter de prendre de l'air. Prendre de l'air pourrait causer l'avarie de l'emplâtre.
- La surface de travail doit être propre afin de tenir loin les facteurs contaminants des matériaux de réparation.
- Ne pas permettre à la solution de sécher complètement avant d'appliquer le caoutchouc ou l'emplâtre permet à la solution mouillée de générer du gaz et cela pourrait causer l'avarie de l'emplâtre.
- N'utiliser jamais de l'air comprimé pour souffler les débris de la surface préparée. Les lignes de l'air contiennent des facteurs contaminants tels que huile, humidité et lubrifiants qui peuvent réduire l'adhésion de façon significative.
- Les pneus doivent être secs avant de faire toutes réparations.
- Toutes réparations doivent être vulcanisées à température, temps et pression spécifiques.
- Endosser toujours des protections pour yeux et oreilles quand on fait les réparations.
- Un éclairage approprié est nécessaire pour l'inspection de la surface.

## MATERIALE AUTOVULCANIZZANTE PATCH RUBBER

PATCH RUBBER SELF-CURING MATERIAL

MATÉRIEL AUTOVULCANISANT PATCH RUBBER

**Pezze per riparazioni camere d'aria - tipo Chemical Cure - rotonde in scatola**

*Round patches for air tubes repairings in boxes - Chemical Cure model*

*Emplâtres ronds pour réparations des chambres à air en boîtes - modèle Chemical Cure*

Codice Code Code	Misura mm. Size in mms. Dimension en mm	Rif. Ref. Réf.	Pz. / scatola Pcs. / box Pcs. / boîte
3070001	Ø 28	12-000	100
3070002	Ø 38	12-001	30
3070003	Ø 51	12-002	30
3070004	Ø 57	12-003	30
3070005	Ø 76	12-016	30
3070006	Ø 92	12-018	10
3070007	Ø 114	12-019	10



3070002



3070007

**Pezze per riparazioni camere d'aria - tipo Chemical Cure - rotonde in secchiello**

*Round patches for air tubes repairings in pails - Chemical Cure model - Emplâtres*

*ronds pour réparations des chambres à air en petits seaux - modèle Chemical Cure*

Codice Code Code	Misura mm. Size in mms. Dimension en mm	Rif. Ref. Réf.	Pz. / secchiello Pcs. / pail Pcs. / petit seau
3070008	Ø 28	12-040	200
3070009	Ø 38	12-041	150
3070010	Ø 51	12-042	100
3070011	Ø 57	12-043	100
3070012	Ø 76	12-044	50



**Pezze per riparazioni camere d'aria - tipo Chemical Cure - ovali in scatola**

*Oval patches for air tubes repairings in boxes - Chemical Cure model*

*Emplâtres ovales pour réparations des chambres à air en boîtes - modèle Chemical Cure*

Codice Code Code	Misura mm. Size in mms. Dimension en mm	Rif. Ref. Réf.	Pz. / scatola Pcs. / box Pcs. / boîte
3070016	38 x 76	12-005	30
3070017	51 x 108	12-006	30
3070018	89 x 152	12-008	10
3070019	114 x 203	12-010	10
3070020	140 x 254	12-012	10



3070017



3070018



### Nota / remark / note:

- Le misure dei rappezzi riportate nel catalogo sono indicative.  
Eventuali variazioni non pregiudicano il tipo di applicazione a cui il rappezzo è destinato.
- Sizes of patches shown in the catalogue are just a reference indication.  
Any variation doesn't affect the type of application for which the patch is designed.
- Les dimensions des emplâtres mentionnées dans le catalogue sont indicatives.  
Des variations éventuelles ne portent pas de préjudice au type d'application auquel l'emplâtre est destiné.

**Rappezzi Bullseye per riparazioni pneumatici radiali tubeless**  
**Patches for repairings of radial tubeless tyres**  
**Emplâtres pour réparations des pneus tubeless radiaux**

Queste unità di riparazione vengono usate per riparare fori e danni alla sezione dei pneumatici radiali vettura, trasporto leggero, camion, trattore a radiali. Un rinforzo speciale riduce gli effetti della flessione. Possono essere usati per riparazioni su corona, spalla e fianchi.

*These repair units are used to repair puncture and section injuries in passenger, light truck, heavy duty truck and farm tractor radial tires. A special reinforcement reduces the effects of flexing. They can be used in crown, shoulder and sidewall repairs.*

*Ces réparations peuvent être utilisées pour réparer trous et dommages à la section de pneus tourisme, camionnette, camion et tracteur radiaux. Un renfort spécial réduit les effets de la flexion. Elles peuvent être utilisées pour les réparations de la couronne, de l'épaule et des flancs.*

**A) Tipo Dual cure / Dual Cure model / Modèle Dual Cure**

Code Code Code	Misura mm Size in mm Dimen. en mm	Rif. Ref. Réf.	Pz. / scatola Pcs. / box Pcs. / boîte	Applicazione Application Application
3070040	55 x 70	BUL DC 10 12-117	20	
3070041	65 x 110	BUL DC 12 12-118	10	
3070042	75 x 135	BUL DC 14 12-119	10	
3070043	70 x 115	BUL DC 20 12-090	10	
3070044	75 x 140	BUL DC 22 12-091	10	
3070045	75 x 195	BUL DC 24 12-092	10	
3070045A	89 x 254	BUL DC 26 12-089	10	
3070046	105 x 205	BUL DC 40 12-093	10	
3070047	135 x 260	BUL DC 42 12-094	10	
3070048	130 x 330	BUL DC 44 12-095	10	
3070050	100 x 130	BUL DC 33 12-096	10	
3070051	125 x 160	BUL DC 35 12-097	10	
3070052	125 x 190	BUL DC 37 12-101	10	
3070054	145 x 205	BUL DC 80 12-060	5	
3070055	190 x 250	BUL DC 82 12-061	5	
3070056	210 x 290	BUL DC 84 12-062	5	
3070057	250 x 350	BUL DC 86 12-063	5	

**B) Tipo Heat Cure / Heat Cure model / Modèle Heat Cure**

Code Code Code	Misura mm Size in mm Dimen. en mm	Rif. Ref. Réf.	Pz. / scatola Pcs. / box Pcs. / boîte	Applicazione Application Application
3070040-HC	55x70	BUL HC 10 12-217	20	
3070041-HC	65X110	BUL HC 12 12-218	10	
3070042-HC	70X135	BUL HC 14 12-219	10	
3070043-HC	70X115	BUL HC 20 12-290	10	
3070044-HC	75X140	BUL HC 22 12-291	10	
3070045-HC	75X195	BUL HC 24 12-292	10	
3070045A-HC	89X254	BUL HC 26 12-289	10	
3070046-HC	105X205	BUL HC 40 12-293	10	
3070047-HC	135X260	BUL HC 42 12-294	10	
3070048-HC	130X330	BUL HC 44 12-295	10	
3070050-HC	100X130	BUL HC 33 12-296	10	
3070051-HC	125X160	BUL HC 35 12-297	10	
3070052-HC	125X190	BUL HC 37 12-301	10	

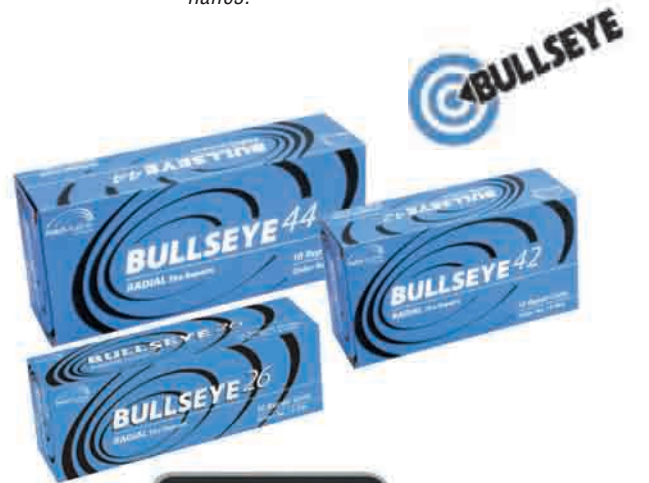

# MATERIALE AUTOVULCANIZZANTE PATCH RUBBER

## PATCH RUBBER SELF-CURING MATERIAL

## MATÉRIEL AUTOVULCANISANT PATCH RUBBER



### Rappezzi Bullseye per riparazioni pneumatici – Nuova gamma "Chemical Line" Patches for reparings of radial tyebelss tyres – New range "Chemical line" Emplâtres pour réparations des pneus tubeless radiaux – Nouvelle gamme "Chemical line"

Codice Code Code	Misura mm Size in mm Dimen. en mm	Rif. Ref. Réf.	Pz. / scatola Pcs. / box Pcs. / boîte	Applicazione Application Application
3070040CH	55 x 70	BUL CHEM 10 12-117-CH	20	
3070041CH	65 x 110	BUL CHEM 12 12-118-CH	10	
3070042CH	75 x 135	BUL CHEM 14 12-119-CH	10	
3070043CH	70 x 115	BUL CHEM 20 12-090-CH	10	
3070044CH	75 x 140	BUL CHEM 22 12-091-CH	10	
3070045CH	75 x 195	BUL CHEM 24 12-092-CH	10	
3070046CH	105 x 205	BUL CHEM 40 12-093-CH	10	
3070047CH	135 x 260	BUL CHEM 42 12-094-CH	10	
3070048CH	130 x 330	BUL CHEM 44 12-095-CH	10	



3070041CH



3070040CH

- Scadenza: 5 anni dalla data di produzione;
- Strato adesivo blu;
- Struttura più rigida ("hard gum");
- Massimi risultati nelle riparazioni a freddo
- Expiry date: 5 years from the date of production;
- Blue bonding layer;
- More rigid frame ("hard gum");
- Max. results in cold repairing
- Echéance : après 5 ans dès la date de production;
- Couche adhésive bleue;
- Structure plus rigide ("hard gum");
- Résultats max. en les réparations à froid

### Rappezzi universali per forature Universal patches for puncture injuries - Emplâtres universels pour crevaisons

Le riparazioni Uni-Patch possono essere utilizzate universalmente per danni da foratura su qualsiasi tipo di pneumatico: vettura, trasporto leggero, camion, a tele diagonali o radiale, con camera o tubeless.

The Uni-Patch Repairs can be universally used for puncture injuries in every type of tyre: passenger, light truck, truck, bias or radial, tubeless or tube-type.

Les réparations Uni-Patch peuvent être utilisées universellement pour dommages causés par crevaison sur n'importe quel type de pneu: tourisme, camionnette, camion, à toiles diagonales ou radial, avec chambre à air ou tubeless.

#### A) Per forature su tutti i tipi di pneumatici

For puncture injures on all type of tyres - Pour crevaisons sur tout type de pneus

Codice Code Code	Misura mm Size in mm Dimen. en mm	Rif. Ref. Réf.	Pz. / scatola Pcs. / box Pcs. / boîte	Applicazione Application Application
3070060	46 x 46	UP 1 14-208	100	
3070060A	46 x 46	UP 1 14-213	250	
3070061	54 x 54	UP 2 14-209	50	
3070061A	54 x 54	UP 2 14-211	200	
3070062	67 x 67	UP 3 14-210	50	
3070062A	67 x 67	UP 3 14-212	150	
3070063	45	RSR 97-935	30	
3070063A	55	RMR 97-936	25	
3070063B	80	RLR 97-937	15	



3070060



3070063A

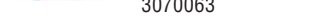

3070063



3070063B

#### B) Per forature su pneumatici a tele diagonali

For puncture injures on bias tyres - Pour crevaisons sur pneus à toiles diagonales

Codice Code Code	Misura mm Size in mm Dimen. en mm	Rif. Ref. Réf.	Pz. / scatola Pcs. / box Pcs. / boîte	Applicazione Application Application
3070065	Ø 45	CX 1 12-021	20	
3070066	Ø 60	CX 2 12-022	20	
3070067	Ø 82	CX 3 12-023	10	
3070068	Ø 118	CX 4 12-024	10	



3070065



3070067



3070066

#### C) Per forature su pneumatici a tele radiali

For puncture injures on radial tyres - Pour crevaisons sur pneus radiaux

Codice Code Code	Misura mm Size in mm Dimen. en mm	Rif. Ref. Réf.	Pz. / scatola Pcs. / box Pcs. / boîte	Applicazione Application Application
3070072	45 x 80	SM.RAD 12-211	20	
3070073	55 x 110	MD.RAD 12-212	10	



3070072

3070073

# MATERIALE AUTOVULCANIZZANTE PATCH RUBBER

PATCH RUBBER SELF-CURING MATERIAL

MATÉRIEL AUTOVULCANISANT PATCH RUBBER

italmatic

## Rappezzi CX per riparazioni pneumatici a tele diagonali - Tipo Dual Cure

*Bias tyres patches series CX - Dual Cure Model*

*Emplâtres série CX pour pneus à toiles diagonales - Modèle Dual Cure*

Le unità di riparazione CX vengono utilizzate per riparazioni sezione, rinforzi, fori sui pneumatici vettura, trasporto leggero, camion, trattore a tele diagonali, con camera o tubeless.

*CX Repair Units are used for puncture, reinforced and section repairs in passenger, light truck, heavy duty truck and tractor bias ply, tube-type or tubeless tires.*

*Les réparations CX sont utilisées pour réparations de la section, des renforts, des crevaisons sur pneus tourisme, camionnette, camion et tracteur à toiles diagonales, avec chambre à air ou tubeless.*

Codice Code Code	Ø mm Ø mm Ø mm	N° Tele N° of plies N° de toiles	Rif. Ref. Réf.	Pz. / scatola Pcs. / box Pcs. / boîte	Applicazione Application Application
3070080	Ø 76	2	CX 3-2 12-142	24	
3070081	Ø 95	2	CX 4-2 12-143	12	
3070082	Ø 152	2	CX 6-2 12-145	12	
3070083	Ø 127	3	CX 5-3 12-146	12	
3070084	Ø 185	3	CX 7-3 12-147	12	
3070085	Ø 152	4	CX 6-4 12-148	12	
3070086	Ø 210	4	CX 8-4 12-150	12	
3070087	Ø 254	4	CX 10-4 12-151	12	
3070088	Ø 330	4	CX 13-4 12-153	6	
3070089	Ø 406	4	CX 16-4 12-154	6	
3070090	Ø 229	6	CX 9-6 12-155	12	
3070091	Ø 305	6	CX 12-6 12-156	6	
3070092	Ø 381	6	CX 15-6 12-157	6	
3070093	Ø 406	8	CX 16-8 12-158	6	
3070094	Ø 457	8	CX 18-8 12-159	6	



## Rappezzi per pneumatici trattore a tele diagonali - Tipo Dual Cure

*Patches for tractor bias tyres - Dual Cure Model*

*Emplâtres pour pneus tracteur à toiles diagonales - Modèle Dual Cure*

Codice Code Code	Misura mm Size in mm Dimen. en mm	N° Tele N° of plies N° de toiles	Rif. Ref. Réf.	Pz. / scatola Pcs. / box Pcs. / boîte	Applicazione Application Application
3070097	229 x 305	4	SKD 1 12-431	5	
3070097C	279 x 381	4	SKD 2 12-432	5	
3070097E	305 x 432	4	SKD 3 12-433	5	
3070097G	330 x 483	4	SKD 4 12-434	5	
3070098	228 x 305	6	SKD 5 12-435	5	
3070099	279 x 381	6	SKD 6 12-436	5	
3070100	305 x 432	6	SKD 7 12-437	5	
3070100C	330 x 483	6	SKD 8 12-438	5	
3070100E	279 x 381	8	HDSKD 6 12-451	5	
3070100G	279 x 381	10	HDSKD 7 12-452	5	
3070100L	305 x 432	10	HDSKD 8 12-453	5	
3070100N	330 x 483	10	HDSKD 9 12-454	5	



3070098

# MATERIALE AUTOVULCANIZZANTE PATCH RUBBER

## PATCH RUBBER SELF-CURING MATERIAL

### MATÉRIEL AUTOVULCANISANT PATCH RUBBER

#### Rappezzi per riparazioni pneumatici E.M. a tele diagonali

#### Patches for E.M Bias tyres

#### Emplâtres pour pneus G.C. à toiles diagonales









Per riparazioni di rinforzi e sezioni in pneumatici E.M. a tele diagonali.

Sono composti da stringhe sovrapposte ed intrecciate per garantire massima flessibilità del rappezzo.









To repair reinforcements and sections in E.M. bias tyres. They consist of overlapped and braided strings to assure max. flexibility of patch.

Pour réparer renforts et sections de pneus G.C. à toiles diagonales. Ils sont composés par de mèches superposées et tressées afin d'assurer une flexibilité maxima de l'emplâtre.









#### A) Tipo Dual cure / Dual Cure model / Modèle Dual Cure

Codice Code Code	Misure mm Size in mm Dimen. en mm	Rif. Ref. Réf.	Pz. / scatola Pcs. / box Pcs. / boîte	Applicazione Application Application
3070101	220	EM DC4 12-304	15	
3070101B	260	EM DC6 12-306	10	
3070101D	325	EM DC8 12-308	8	
3070101F	380	EM DC10 12-310	6	
3070101K	440	EM DC12 12-312	5	
3070101M	475	EM DC14 12-314	5	
3070101P	535	EM DC16 12-316	2	
3070101R	590	EM DC18 12-318	1	
3070101T	690	EM DC20 12-320	1	

#### B) Tipo Uncured / Uncured model / Modèle Uncured

Codice Code Code	Misure mm Size in mm Dimen. en mm	Rif. Ref. Réf.	Pz. / scatola Pcs. / box Pcs. / boîte	Applicazione Application Application
3070101-UN	220	EM 4 10-304	15	
3070101B-UN	260	EM 6 10-306	10	
3070101D-UN	325	EM 8 10-308	8	
3070101F-UN	380	EM 10 10-310	6	
3070101K-UN	440	EM 12 10-312	5	
3070101M-UN	475	EM 14 10-314	5	
3070101P-UN	535	EM 16 10-316	2	
3070101R-UN	590	EM 18 10-318	1	
3070101T-UN	690	EM 20 10-320	1	

#### C) Tipo Heat Cure / Heat Cure model / Modèle Heat Cure

Codice Code Code	Misure mm Size in mm Dimen. en mm	Rif. Ref. Réf.	Pz. / scatola Pcs. / box Pcs. / boîte	Applicazione Application Application
3070101-HC	220	EM HC 4 12-404	15	
3070101B-HC	260	EM HC 6 12-406	10	
3070101D-HC	325	EM HC 8 12-408	8	
3070101F-HC	380	EM HC 10 12-410	6	
3070101K-HC	440	EM HC 12 12-412	5	
3070101M-HC	475	EM HC 14 12-414	5	
3070101P-HC	535	EM HC 16 12-416	2	
3070101R-HC	590	EM HC 18 12-418	1	
3070101T-HC	690	EM HC 20 12-420	1	



# MATERIALE AUTOVULCANIZZANTE PATCH RUBBER

PATCH RUBBER SELF-CURING MATERIAL

MATÉRIEL AUTOVULCANISANT PATCH RUBBER

italmatic

## Rappezzi Bullseye per riparazioni pneumatici E.M. radiali Bullseye patches for E.M. radial tyres Emplâtres Bullseye pour pneus G.C. radiaux



### A) Per riparazioni di sezioni in pneumatici E.M. radiali - Tipo Dual Cure

To repair sections in E.M. radial tyres - Dual Cure Model

Pour réparer sections de pneus G.C. radiaux - Modèle Dual Cure

Codice Code Code	Misure mm Size in mm Dimen. en mm	Rif. Ref. Réf.	Pz. / scatola Pcs. / box Pcs. / boîte	Applicazione Application Application
3070102	155 x 440	BUL DC 46 12-070	5	
3070102B	215 x 585	BUL DC 50 12-071	5	
3070102D	265 x 595	BUL DC 52 12-072	5	
3070102F	210 x 750	BUL DC 56 12-073	2	
3070102K	210 x 1005	BUL DC 60 12-074	2	

### B) Per riparazioni di danni alla corona in pneumatici E.M. radiali - Tipo Dual Cure

To repair damages to crown in E.M. radial tyres - Dual Cure Model

Pour réparer dommages à la couronne de pneus G.C. radiaux - Modèle Dual Cure

Codice Code Code	Misure mm Size in mm Dimen. en mm	Rif. Ref. Réf.	Pz. / scatola Pcs. / box Pcs. / boîte	Applicazione Application Application
3070103	229 x 190	BUL DC 45 12-069	5	
3070103B	330 x 254	BUL DC 55 12-075	5	
3070103D	405 x 305	BUL DC 65 12-076	3	
3070103F	533 x 432	BUL DC 75 12-077	3	



### C) Per riparazioni di sezioni in pneumatici E.M. radiali - Tipo Heat Cure

To repair sections in E.M. radial tyres - Heat Cure model

Pour réparer sections de pneus G.C. radiaux - modèle Heat Cure

Codice Code Code	Misure mm Size in mm Dimen. en mm	Rif. Ref. Réf.	Pz. / scatola Pcs. / box Pcs. / boîte	Applicazione Application Application
3070102-HC	155x440	BUL HC 46 12-270	5	
3070102B-HC	215x585	BUL HC 50 12-271	5	
3070102D-HC	265x595	BUL HC 52 12-272	5	
3070102F-HC	290x750	BUL HC 56 12-273	2	
3070102K-HC	290x1005	BUL HC 60 12-274	2	



### D) Per riparazioni di danni alla corona in pneumatici E.M. radiali - Tipo Heat Cure

To repair damages to crown in E.M. radial tyres - Heat Cure model

Pour réparer dommages à la couronne de pneus G.C. radiaux - modèle Heat Cure

Codice Code Code	Misure mm Size in mm Dimen. en mm	Rif. Ref. Réf.	Pz. / scatola Pcs. / box Pcs. / boîte	Applicazione Application Application
3070103-HC	230x190	BUL HC 45 12-269	5	
3070103B-HC	330x255	BUL HC 55 12-275	5	
3070103D-HC	405x305	BUL HC 65 12-276	3	
3070103F-HC	535x430	BUL HC 75 12-277	3	

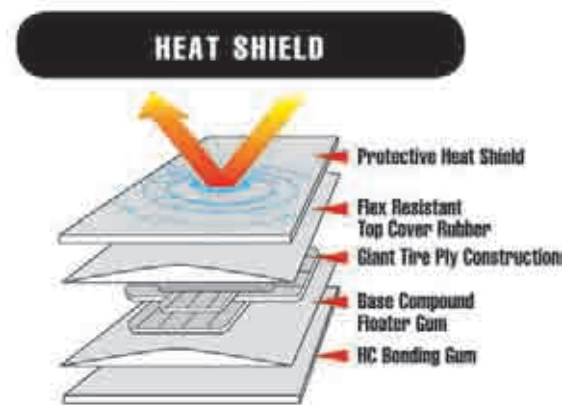

#### Nota:

I rappezzi Heat Cure per pneumatici radiali Giganti (E.M., OTR), sono ricoperti da uno speciale strato resistente al calore (marchiato "Heat Shield Protected") che protegge l'unità di riparazione dall'ossidazione e degrado per il calore derivante dalle temperature estreme a cui normalmente operano questi pneumatici.

#### Note:

Heat Cure Giant Tire Repair Units (E.M., OTR) are covered with a special heat-resistant layer (marked by a Heat Shield Protected decal), which protects the repair unit from oxidation and heat degradation caused by the extreme operating temperatures common in giant tires.

#### Note:

Les emplâtres Heat Cure pour pneus radiaux G.C. et OTR sont couverts par une couche spéciale résistante à la chaleur (marquée "Heat Shield Protected") qui protège l'unité de réparation de l'oxydation et de la dégradation dû à la chaleur provenant par les températures extrêmes auxquelles ces pneus travaillent normalement.



# MATERIALE AUTOVULCANIZZANTE PATCH RUBBER

## PATCH RUBBER SELF-CURING MATERIAL

## MATÉRIEL AUTOVULCANISANT PATCH RUBBER

### Rappezzi Bullseye rinforzati con fibre di Aramide per riparazioni pneumatici E.M. radiali Aramid fibers reinforced Bullseye patches for E.M. radial tyres Emplâtres Bullseye renforcés par fibres de Aramide pour pneus G.C.

I rinforzi di fibre di aramide sono più forti e leggeri del nylon o dell'acciaio. Riducono l'effetto rigonfiamento nella riparazione dei fianchi di pneumatici radiali.

The reinforcing Aramid fibers are stronger and lighter than nylon or steel reinforced units. They reduce the "bulge effect" in radial sidewall section repairs.

Les renforts en fibres de Aramide sont plus forts et légers du nylon et de l'acier. Ils réduisent l'effet gonflement en la réparation des flancs de pneus radiaux.

#### A) Per riparazioni di sezioni in pneumatici E.M. radiali - Tipo Heat Cure

To repair sections in E.M. radial tyres - Heat Cure model

Pour réparer sections de pneus G.C. radiaux - modèle Heat Cure



Codice Code Code	Misure mm Size in mm Dimen. en mm	Rif. Ref. Réf.	Pz. / scatola Pcs. / box Pcs. / boîte	Applicazione Application Application
3070104-HC	125x405	BUL HC 46 STS 13-846	5	
3070104A-HC	180x535	BUL HC 50 STS 13-850	5	
3070104B-HC	230x535	BUL HC 52 STS 13-852	5	
3070104C-HC	230x710	BUL HC 56 STS 13-856	2	
3070104D-HC	255x965	BUL HC 60 STS 13-860	2	

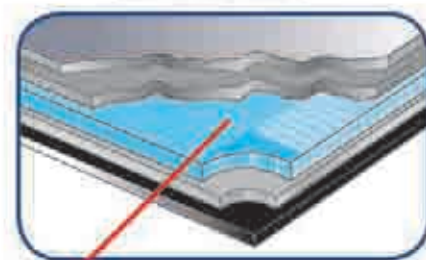

Reinforced with Aramid Fibers

#### B) Per riparazioni di danni alla corona in pneumatici E.M. radiali - Tipo Heat Cure

To repair damages to crown in E.M. radial tyres - Heat Cure model

Pour réparer dommages à la couronne de pneus G.C. radiaux - modèle Heat Cure



Codice Code Code	Misure mm Size in mm Dimen. en mm	Rif. Ref. Réf.	Pz. / scatola Pcs. / box Pcs. / boîte	Applicazione Application Application
3070104E-HC	230x190	BUL HC 45 STS 13-845	5	
3070104F-HC	330x225	BUL HC 55 STS 13-855	5	
3070104G-HC	430x345	BUL HC 65 STS 13-865	3	
3070104H-HC	535x430	BUL HC 75 STS 13-875	3	
3070104J-HC	735x570	BUL HC 85 STS 13-885	1	

#### C) Per riparazioni di sezioni in pneumatici E.M. radiali - Tipo Clothback

To repair sections in E.M. radial tyres - Clothback model

Pour réparer sections de pneus G.C. radiaux - modèle Clothback



Codice Code Code	Misure mm Size in mm Dimen. en mm	Rif. Ref. Réf.	Pz. / scatola Pcs. / box Pcs. / boîte	Applicazione Application Application
3070104-CB	125x405	BUL CB 46 STS 13-946	5	
3070104A-CB	180x535	BUL CB 50 STS 13-950	5	
3070104B-CB	230x535	BUL CB 52 STS 13-952	5	
3070104C-CB	230x710	BUL CB 56 STS 13-956	2	
3070104D-CB	255x965	BUL CB 60 STS 13-960	2	



#### D) Per riparazioni di danni alla corona in pneumatici E.M. radiali - Tipo Clothback

To repair damages to crown in E.M. radial tyres - Clothback model

Pour réparer dommages à la couronne de pneus G.C. radiaux - modèle Clothback



Codice Code Code	Misure mm Size in mm Dimen. en mm	Rif. Ref. Réf.	Pz. / scatola Pcs. / box Pcs. / boîte	Applicazione Application Application
3070104E-CB	230x190	BUL CB 45 STS 13-945	5	
3070104F-CB	330x225	BUL CB 55 STS 13-955	5	
3070104G-CB	430x345	BUL CB 65 STS 13-965	3	
3070104H-CB	535x430	BUL CB 75 STS 13-975	3	
3070104J-CB	735x570	BUL CB 85 STS 13-985	1	



**Funghetti per riparazioni pneumatici radiali - tipo Dual Cure**

**Plugs for radial tyres - Dual Cure model**

**Emplâtres en forme de champignon pour pneus radiaux - modèle Dual Cure**

I funghetti per riparazione vanno utilizzati per forature solo se l'angolo della penetrazione è inferiore a 20° rispetto alla perpendicolare. Per angoli maggiori, utilizzare un plug stem ed il rappezzo appropriato.

Pilot Wire patch plugs are to be used for punctures only if the angle of penetration is not more than 20° from the perpendicular. If the angle is greater than 20° use a separate plug stem and the appropriate repair unit.

Les chevilles champignon pour réparation doivent être utilisées pour crevaisons seulement si l'angle de la pénétration est inférieur à 20° comparé à la perpendiculaire. Pour angles majeurs, utiliser un plug stem et l'emplâtre approprié.

Codice Code Code	Descrizione Description Description	Note Notes Notes	Misura mm Size in mm Dimension en mm	Rif. Ref. Réf.	Pz. / scatola Pcs. / box Pcs. / boîte	Applicazione Application Application
3070105	Funghetti / Plugs Chevilles champignon		3 X 40	14-040	18	
3070105M	Funghetti / Plugs Chevilles champignon	Michelin	Ø 3	4953-1	40	
3070105S	Funghetti / Plugs Chevilles champignon	Michelin	Ø 4,5	42866-67	40	
3070106	Funghetti / Plugs Chevilles champignon		6 X 75	14-041	18	
3070106M	Funghetti / Plugs Chevilles champignon	Michelin	Ø 6	4956-1	24	
3070107	Funghetti / Plugs Chevilles champignon		9 X 75	14-042	18	
3070107M	Funghetti / Plugs Chevilles champignon	Michelin	Ø 10	4955-1	10	



**Smerigliatrice e frese Carbide / Grinder and Carbide cutters / Ponceuse et fraises Carbide**

Codice Code Code	Descrizione Description Description	Misura mm Size in mm Dimension en mm	Rif. Ref. Réf.	Pz. / scatola Pcs. / box Pcs. / boîte
3070108A	Fresa carbide / Carbide cutter - Fraise carbide	Ø 3	42-393	1
3070108B	Fresa carbide / Carbide cutter - Fraise carbide	Ø 6	42-372	1
3070108C	Fresa carbide / Carbide cutter - Fraise carbide	Ø 9	42-369	1
3070108E	Fresa carbide / Carbide cutter - Fraise carbide	Ø 4,76	42-378	1
3070108F	Fresa carbide / Carbide cutter - Fraise carbide	Ø 7,94	42-379	1
3070108G	Fresa carbide / Carbide cutter - Fraise carbide	Ø 11,11	42-373	1
3070108H	Fresa carbide / Carbide cutter - Fraise carbide	Ø 12,70	42-164	1
3070108S	Smerigliatrice 22.000 giri/min. - Grinder 22.000 RPM - Ponceuse 22.000 Tours/minute			



**Funghetti Speedy plugs per pneumatici radiali e a tele diagonali - tipo Dual Cure**

**Speedy plugs for radial and bias tyres - Dual Cure model**

**Emplâtres Speedy plugs pour pneus radiaux et à toiles diagonales - modèle Dual Cure**

Codice Code Code	Descrizione Description Description	Misura mm Size in mm Dimension en mm	Rif. Ref. Réf.	Pz. / scatola Pcs. / box Pcs. / boîte	Applicazione Application Application
3070109	Funghetti speedy plugs / Speedy plugs Chevilles champignon speedy plugs	3 X 47	97-381	18	
3070110	Funghetti speedy plugs / Speedy plugs Chevilles champignon speedy plugs	6 X 57	14-508	25	
3070111	Funghetti speedy plugs / Speedy plugs Chevilles champignon speedy plugs	8 X 57	14-509	25	
3070112	Funghetti speedy plugs / Speedy plugs Chevilles champignon speedy plugs	10 X 102	14-510	10	
3070113	Funghetti speedy plugs / Speedy plugs Chevilles champignon speedy plugs	13 X 102	14-511	10	



# MATERIALE AUTOVULCANIZZANTE PATCH RUBBER

## PATCH RUBBER SELF-CURING MATERIAL

### MATÉRIEL AUTOVULCANISANT PATCH RUBBER

#### Inserti a farfalla









#### Bow Tie inserts

#### Réparations en forme de papillon

Questi inserti sono fabbricati con una gomma ad alta resistenza e sono ideali per riparazioni di forature irregolari

*These inserts are manufactured with specially formulated high tensile rubber and are recommended to repair not regular shape punctures*

*Ces réparations sont fabriqués avec un caoutchouc à haute résistance et sont idéales pour réparations de crevaisons irrégulières*

Codice Code Code	Descrizione Description Description	Misura mm Size in mm Dimension en mm	Rif. Ref. Réf.	Pz. / scatola Pcs. / box Pcs. / boîte	Applicazione Application Application
3070114	Inserti a farfalla per vettura <i>Bow tie inserts for car</i> <i>Réparations en forme de papillon - tourisme</i>	10x60	14-556	50	  
3070114B	Inserti a farfalla per camion <i>Bow tie inserts for truck</i> <i>Réparations en forme de papillon - camion</i>	15x80	14-557	20	  
3070114D	Inserti a farfalla per E.M. <i>Bow tie inserts for E.M.</i> <i>Réparations en forme de papillon - G.C.</i>	20x100	14-558	20	  











#### Plug Stem / Plug Stem / Plug Stem

Questi inserti sono raccomandati nella riparazione di forature con angolo che eccede i 20 gradi dalla perpendicolare. Un rappizzo deve essere installato sul plug stem, dopo la sua installazione, per ottenere una riparazione permanente.

*These inserts are recommended for use in punctures at an angle that exceeds 20 degrees from perpendicular. A repair unit should be installed over the plug, after installation, to make this a permanent repair.*

*Ces réparations sont idéales pour les crevaisons qui dépassent les 20 degrés par la perpendiculaire. Un emplâtre doit être installé sur le plug stem, après son installation, pour obtenir une réparation permanente.*

Codice Code Code	Descrizione Description Description	Misura mm Size in mm Dimension en mm	Rif. Ref. Réf.	Pz. / scatola Pcs. / box Pcs. / boîte	Applicazione Application Application
3070114G	Plug stem <i>Plug Stem</i> <i>Plug Stem</i>	3	14-568	50	  
3070114H	Plug stem <i>Plug Stem</i> <i>Plug Stem</i>	6	14-569	40	  
3070114J	Plug stem <i>Plug Stem</i> <i>Plug Stem</i>	10	14-570	25	  









3070114G



3070114H

#### Inserti ovali e rotondi / Oval and round inserts / Réparations ovales et rondes

Codice Code Code	Descrizione Description Description	Misura mm Size in mm Dimension en mm	Rif. Ref. Réf.	Pz. / scatola Pcs. / box Pcs. / boîte	Applicazione Application Application
3070115	Inserti ovali per vettura <i>Oval inserts for car</i> <i>Réparations ovales pour tourisme</i>	10 x 51	14-533	20	 
3070116	Inserti ovali per camion <i>Oval inserts for truck</i> <i>Réparations ovales pour camion</i>	10 x 229	14-535	15	
3070116B	Inserti rotondi per vettura <i>Round inserts for car</i> <i>Réparations rondes pour tourisme</i>	6 x 50	14-532	20	 
3070116C	Inserti rotondi per camion <i>Round inserts for truck</i> <i>Réparations rondes pour camion</i>	6 x 200	14-534	15	
3070116E	Inserti per riparazioni forature pneumatici OTR <i>Inserts for OTR tyres puncture repair</i> <i>Réparations pour crevaisons des pneus OTR</i>	15 x 200	98-023	10	



**Funghetti e pistola / Plugs and gun / Emplâtres en forme de champignon et pistolet**

Codice Code Code	Descrizione Description Description	Rif. Ref. Réf.	Pz. / scatola Pcs. / box Pcs. / boîte
3070118	Funghetti da 3/8" - 10mm 3/8" plugs - 10mm Emplâtres en forme de champignon de 3/8" - 10mm	15 - 032	25
3070119	Funghetti da 5/16" - 8mm 5/16" plugs - 8mm Emplâtres en forme de champignon de 5/16" - 8mm	15 - 033	25
3070120	Funghetti da 7/16" - 11mm 7/16" plugs - 11mm Emplâtres en forme de champignon de 7/16" - 11mm	15 - 034	15
3070121	Pistola manuale per funghetti Manual gun for plugs Pistolet manuel pour emplâtres en forme de champignon	15 - 025	1
3070122	Adattatore per funghetti 5/16" - 8mm Adaptator for plugs 5/16" - 8mm Adaptateur pour emplâtres en forme de champignon de 5/16" - 8mm	15 - 026	1
3070123	Adattatore per funghetti 7/16" - 11mm Adaptator for plugs 7/16" - 11mm Adaptateur pour emplâtres en forme de champignon de 7/16" - 11mm	15 - 027	1



3070121

3070118



3070125



3070126



3070127

**Stringhe / Strings / Mèches**

Codice Code Code	Descrizione Description Description	Note Notes Notes	Rif. Ref. Réf.	Pz. / scatola Pcs. / box Pcs. / boîte
3070124	Stringhe mini Monofil R - 5mm - 4" Mini Monofil R strings - 5mm - 4" Mèches mini Monofil R - 5mm - 4"		15-049	50
3070125	Stringhe Monofil da 4" - 6mm - 4" 4" Monofil strings - 6mm - 4" Mèches Monofil 4" - 6mm - 4"		15-050	50
3070126	Stringhe per vettura da 4" marroni 4" car strings brown Mèches tourisme 4" marron	Ø 5mm - Italmatic	--	50
3070126P	Stringhe per vettura da 4" 4" car strings Mèches tourisme 4"	Ø 5mm - Patch Rubber	15-058	50
3070126B	Stringhe per vettura da 8" nere 8" car strings black Mèches tourisme 8" noir	Ø 3mm	15-158	50
3070127	Stringhe autocarro da 8" marroni 8" truck strings brown Mèches camion 8" marron	Ø 5mm - Italmatic	--	25
3070127P	Stringhe autocarro da 8" 8" truck strings Mèches camion 8"	Ø 5mm - Patch Rubber	15-061	25

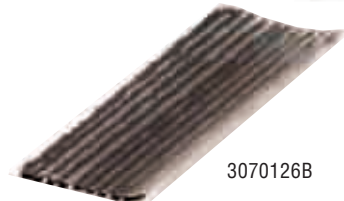

3070126B



3070126P

# MATERIALE AUTOVULCANIZZANTE PATCH RUBBER

## PATCH RUBBER SELF-CURING MATERIAL

## MATÉRIEL AUTOVULCANISANT PATCH RUBBER

### Procedura di applicazione funghetti

### Plugs application procedure - Procédure d'application emplâtres en forme de champignon



Rimuovere corpi estranei e sondare il danno con un punteruolo smussato per determinare l'angolo di penetrazione\*

\* Nota: Se l'angolo è maggiore di 20° perpendicolarmente, non usare la combinazione rappazzo-funghetto. Utilizzare un funghetto separato e l'unità di riparazione appropriata.

Remove foreign object and probe the injury with a blunt awl to determine the angle of penetration\*

\*Note: If the angle is more than 20° from perpendicular, do not use the combination patch-plug. Use a separate plug stem and the appropriate repair unit.

Enlever les corps étrangers et sonder le dommage par un poinçon arrondi afin de déterminer l'angle de pénétration\*

\*Note: Si l'angle est majeur de 20° perpendiculairement, ne pas utiliser la combinaison emplâtre-emplâtre en forme de champignon. Utiliser un emplâtre en forme de champignon séparé et l'unité de réparation appropriée.



Pulire la zona attorno al danno con il Fluido Pulente Patch Rubber ed un raschietto.

Clean the area around the injury with Patch Rubber Cleaner Fluid and a scraper.

Nettoyer la zone autour du dommage par le fluide nettoyant Patch Rubber et un racloir.

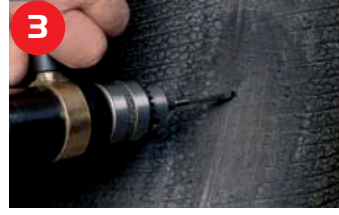

Usare un trapano a bassa velocità (500-700 giri/min) e la fresa carbide di dimensioni appropriate\*, alesare il danno seguendo l'angolo di penetrazione quattro volte dall'interno del pneumatico e quattro volte dall'esterno del pneumatico.

Using a low speed drill (500-700 RPM) and the appropriate size carbide cutter\*, ream the injury following the angle of penetration four times from the inside of the tire, and four times from the outside.

Utiliser une foreuse à basse vitesse (500-700 tours/min) et la fraise carbide de dimensions appropriées\*, aléser le dommage en suivant l'angle de pénétration quatre fois par l'intérieur du pneu et quatre fois par l'extérieur du pneu.



Utilizzare una raspetta a bassa velocità (max. 5000 giri/min) ed una mola di rasatura per raspare il bordo interno di 1/2" più largo del rappazzo (RMA = 1 grado di rasatura)

Use a low speed buffer (max. 5000 RPM) and a buffing stone to buff the innerliner 1/2" larger than the patch (RMA #1 Buffing Texture.)

Utiliser une râpe à basse vitesse (max. 5000 tours/min) et une meule de râpage pour râper le bord intérieur de 1/2" plus large de l'emplâtre (RMA = 1 degré de râpage)



Togliere la polvere di rasatura aspirando, poi pulire la zona rasata con il fluido pulente ed un raschietto per evitare di contaminare il canale del danno.

Remove buffing dust with a vacuum, then clean the buffed area with cleaner fluid and a scraper to avoid contaminating the injury channel.

Enlever la poudrette de râpage en aspirant, après nettoyer la zone râpée par le fluide nettoyant et un racloir afin d'éviter de contaminer le canal du dommage.



Applicare uno strato uniforme di soluzione autovulcanizzante Fast-Dry Patch Rubber sulla zona rasata. Lasciar asciugare completamente. Il tempo di asciugatura varierà a seconda della temperatura e dell'umidità.

Apply an even coat of Patch Rubber Fast-Dry Self-Vulcanizing Cement to the buffed area. Allow to dry completely. Drying time will vary depending on temperature and humidity.

Appliquer une couche uniforme de solution autovulcanisante Fast-Dry Patch Rubber sur la zone râpée. Laisser sécher complètement. Le temps de séchage changera selon la température et l'humidité.



Immergere il punteruolo nella soluzione ed inserirlo nel danno per lubrificare il danno.

Dip awl into cement and insert into injury to lubricate the injury.

Plonger le poinçon dans la solution et l'insérer dans le dommage pour lubrifier le dommage.



Mentre la soluzione è ancora bagnata, inserire il cavo guida attraverso il danno dall'interno. Usare le pinze, afferrare il gambo dietro al cavo e tirare fino a quando il rappazzo è posizionato contro il bordo interno. Non tirare troppo causando la depressione del rappazzo.

While the cement is still wet, insert the guide wire through the injury from the inside. Using pliers, grasp stem behind the wire and pull until the patch is seated against the innerliner. Do not over-pull and cause the patch to dimple.

Quand la solution est encore mouillée, insérer le câble guide à travers le dommage par l'intérieur. Utiliser les pinces, prendre la tige derrière le câble et tirer jusqu'à quand l'emplâtre est positionné contre le bord intérieur. Ne tirer pas trop en causant la dépression de l'emplâtre.



Far aderire il rappazzo vigorosamente dal centro lavorando verso l'esterno. Impiegare la maggior pressione manuale possibile.

Stitch the repair unit vigorously from the center working outwardly. Use as much hand pressure as possible.

Faire adhérer l'emplâtre avec force du centre en travaillant vers l'extérieur. Utiliser la majeure pression manuelle possible.



Applicare sigillante per riparazioni Patch Rubber nella zona rasata in eccesso.

Apply Patch Rubber Repair Sealer to the over buff area.

Appliquer la solution adhésive pour réparations Patch Rubber dans la zone râpée en excès.



Applicare sigillante talloni Patch Rubber sul tallone del pneumatico prima del gonfiaggio per prevenire perdita d'aria attorno al tallone.

Apply Patch Rubber Bead Sealer to the bead of the tire before inflation to help prevent air loss around the bead.

Appliquer la solution adhésive talons Patch Rubber sur le talon du pneu avant du gonflage pour prévenir des pertes d'air autour du talon.



Dopo il gonfiaggio, tagliare il funghetto a livello con la zona battistrada esterna. Rimettere il pneumatico in uso.

After inflating, cut the plug flush with the outside tread area. Return tire to service.

Après le gonflage, couper l'emplâtre en forme de champignon à niveau de la zone de la chape extérieure. Remettre le pneu en service.

# MATERIALE AUTOVULCANIZZANTE PATCH RUBBER

## PATCH RUBBER SELF-CURING MATERIAL

### MATÉRIEL AUTOVULCANISANT PATCH RUBBER

italmatic



3070127T



3070127U



3070127V



3070127W

### Starting kit riparazione / Starting repairs kits / Starting kits pour réparations

Codice Code Code	Descrizione Description Description	Rif. Ref. Réf.	Contenuto di ogni kit Content of each kit Contenu de chaque kit
3070127T	Starting Kit riparazione pneumatici per garage e concessionarie <i>Starting repair kit for auto dealership</i> <i>Starting Kit pour réparation pneus pour garages et concessionnaires</i>	47-110	1 sc. 14-040, 1 sc. 14-041, 1 pz. 16-118, 1 pz. 16-170, 1 pz. 16-451, 1 pz. 16-483; 1 pz ciascuno per: pinza, contenitore, smerigliatrice, rullino, raschietto, adattatore 3/16", tool fresa carbide, mola per gomma, occhiali di protezione, scatola di 12 gessi gialli, spazzola, punteruolo, vaschetta. <i>1 box 14-040, 1 box 14-041, 1 pc. 16-118, 1 pc. 16-170, 1 pc. 16-451, 1 pc. 16-483; 1 pc. each for: pliers, container, low speed grinder, stitcher, scraper, adapter 3/16", carbide cutting tool, buffing stone, safety glasses, box of 12 yellow crayons, brush, prob awl, bowl.</i> <i>1 boîte 14-040, 1 boîte 14-041, 1 pc. 16-118, 1 pc. 16-170, 1 pc. 16-451, 1 pc. 16-483; 1 pièce chaque pour : pince, récipient, meuleuse, rouleau, grattoir, adaptateur 3 / 16", de fraise carbide, meule pour caoutchouc, lunettes de protection, boîte de 12 craies jaunes, brosse, poinçon, bol.</i>
3070127U	Starting kit di riparazione forature pneumatici vettura. <i>Starting repair kit for punctures in passenger tyre</i> <i>Starting Kit pour réparation pneus tourisme</i>	47-101	2 sc. 12-117, 1 sc. 14-209, 1 sc. 14-569, 1 sc. 14-526, 1 pz. 16-118, 1 pz. 16-170, 1 pz. 16-451, 1 pz. 16-471; 1 pz ciascuno per: pinza, contenitore, smerigliatrice, rullino, raschietto, adattatore 3/16", tool fresa carbide, attrezzo ad ago, mola per gomma, occhiali di protezione, scatola di 12 gessi gialli, spazzola, punteruolo, coltello a lama flessibile, cassetta attrezzi. <i>2 boxes 12-117, 1 box 14-209, 1 box 14-569, 1 box 14-526, 1 pc. 16-118, 1 pc. 16-170, 1 pc 16-451, 1 pc 16-471 ; 1 pc each for: pliers, container, low speed grinder, stitcher, scraper, adapter 3/16", carbide cutting tool, needle tool, buffing stone, safety glasses, box of 12 yellow crayons, brush, flexible blade knife, probe awl, heavy duty tool box.</i> <i>2 boîtes 12-117, 1 boîte 14-209, 1 boîte 14-569, 1 boîte 14-526, 1 pc. 16-118, 1 pc. 16-170, 1 pc. 16-451, 1 pc. 16-471; 1 pièce chaque pour : pince, récipient, meuleuse, rouleau, grattoir, adaptateur 3 / 16", de fraise carbide, outil avec aiguille meule pour caoutchouc, lunettes de protection, boîte de 12 craies jaunes, brosse, poinçon, couteaux à lame souple, boîte à outils.</i>
3070127V	Starting Kit di riparazione forature pneumatici autocarro <i>Starting repair kit for punctures in truck tyre</i> <i>Starting Kit pour réparation pneus camion</i>	47-102	1 sc. 14-202, 1 sc. 12-117, 1 sc. 12-118, 1 sc. 12-021, 1 sc. 12-142, 1 sc. 14-569, 1 sc. 14-570, 1 pz. 16-118, 1 pz. 16-170, 1 pz. 16-451, 1 pz. 16-471; 1 pz ciascuno per: pinza, contenitore, smerigliatrice, rullino, raschietto, adattatore 3/16", tool fresa carbide, attrezzo ad ago, mola per gomma, occhiali di protezione, scatola di 12 gessi gialli, spazzola, punteruolo, coltello a lama flessibile, cassetta attrezzi. <i>1 box 14-202, 1 box 12-117, 1 box 12-118, 1 box 12-021, 1 box 12-142, 1 box 14-569, 1 box 14-570, 1 pc. 16-118, 1 pc 16-170, 1 pc. 16-451, 1 pc. 16-471; 1 pc each for : pliers, container, low speed grinder, stitcher, scraper, adapter 3/16", carbide cutting tool, buffing stone, needle tool, safety glasses, box of 12 yellow crayons, brush, flexible blade knife, probe awl, heavy duty tool box.</i> <i>1 boîte 14-202, 1 boîte 12-117, 1 boîte 12-118, 1 boîte 12-021, 1 boîte 12-142, 1 boîte 14-569, 1 boîte 14-570, 1 pc. 16-118, 1 pc. 16-170, 1 pc. 16-451, 1 pc. 16-471; 1 pièce chaque pour : pince, récipient, meuleuse, rouleau, grattoir, adaptateur 3 / 16", de fraise carbide, outil avec aiguille meule pour caoutchouc, lunettes de protection, boîte de 12 craies jaunes, brosse, poinçon, couteaux à lame souple, boîte à outils.</i>
3070127W	Armadietto per stoccaggio materiale di riparazione <i>Dispenser cabinet for repairing material</i> <i>Armoire pour stockage matériel de réparation</i>	14-219	Vuoto <i>Empty</i> <i>Vide</i>

# MATERIALE AUTOVULCANIZZANTE PATCH RUBBER

## PATCH RUBBER SELF-CURING MATERIAL

### MATÉRIEL AUTOVULCANISANT PATCH RUBBER



3070130



3070129Z



3070128



3070129



3070131A



3070131B

### Kits di riparazione / Repairings kits / Kits de réparations

Codice Code Code	Descrizione Description Description	Rif. Ref. Réf.	Contenuto di ogni kit Content of each kit Contenu de chaque kit
3070128	Kit riparazione ciclo <i>Bike repairing kit</i> <i>Kit de réparation vélo</i>	15-274	5 pezzi riparazione + 1 soluzione + 1 raschietto <i>5 patches for repairing + 1 cement + 1 scraper</i> <i>5 emplâtres + 1 solution + 1 racloir</i>
3070129	Kit riparazione moto economico <i>Cheap motorcycle repairing kit</i> <i>Kit de réparation motocycle économique</i>	15-275	4 pezzi riparazione + 1 soluzione + 1 raschietto <i>4 patches for repairing + 1 cement + 1 scraper</i> <i>4 emplâtres + 1 solution + 1 racloir</i>
3070129Z	Kit stringhe per riparaz. vettura non infiammabile <i>Strings kit for car repairing non flammable</i> <i>Kit mèches pour réparation pneus tourisme - non inflammable</i>	15-057	50 stringhe marroni vettura / utensile a T / ago vettura / utensile a T con soluzione a spirale / soluzione solida <i>50 passenger brown string / T-handle tool/Passenger needle / T-handle with spiral cement tool / solid cement</i> <i>50 mèches marron tourisme / outil à T / aiguille tourisme / outil à T avec solution à spirale / solution solide</i>
3070130	Kit stringhe per ripar. vettura <i>Strings kit for car repairings</i> <i>Kit de mèches pour réparations tourisme</i>	-	50 stringhe 15-058 + 1 raspetta 15-114 + 1 attrezzo a T 15-066 + 1 soluzione 16-451 <i>50 strings 15-058 + 1 probe rasp 15-114 + 1 T handle tool 15-066 + 1 cement 16-451</i> <i>50 mèches 15-058 + 1 râpe 15-114 + 1 outil à T 15-066 + 1 solution 16-451</i>
3070130Z	Kit stringhe per riparaz. autocarro non infiammabile <i>Strings kit for truck repairing non flammable</i> <i>Kit mèches pour réparation pneus camion - non inflammable</i>	15-060	25 stringhe marroni autocarro / utensile a T / ago autocarro / utensile a T con soluzione a spirale / soluzione solida <i>25 truck brown strings / T-handle tool / Truck needle / T-handle with spiral cement tool / solid cement</i> <i>25 mèches marron camion / outil à T / aiguille camion / outil à T avec solution à spirale / solution solide</i>
3070131	Kit stringhe per ripar. autocarro <i>Strings kit for truck repairings</i> <i>Kit de mèches pour réparations camion</i>	-	25 stringhe 15-061 + 1 raspetta 15-114 + 1 attrezzo a T 15-069 + 1 soluzione 16-451 <i>25 strings 15-061 + 1 probe rasp 15-114 + 1 T handle tool 15-069 + 1 cement 16-451</i> <i>25 mèches 15-061 + 1 râpe 15-114 + 1 outil à T 15-069 + 1 solution 16-451</i>
3070131A	Kit rappezzi autocarro <i>Truck repairing kit</i> <i>Kit de réparation camion</i>	15-276	22 rappezzi + 1 soluzione + 1 raschietto <i>22 patches for repairing + 1 cement + 1 scraper</i> <i>22 emplâtres + 1 solution + 1 racloir</i>
3070131B	Kit rappezzi trattore/M.T. <i>Tractor/E.M. repairing kit</i> <i>Kit de réparation tracteur/G.C.</i>	15-277	33 rappezzi + 1 soluzione + 1 raschietto <i>33 patches for repairing + 1 cement + 1 scraper</i> <i>33 emplâtres + 1 solution + 1 racloir</i>

### Bombolette di gonfiaggio Inflating cylinder Cylindre de gonflage

Codice Code Code	Descrizione Description Description	Pz. / scatola Pcs. / box Pcs. / boîte
3070132A	Bomboletta di gonfiaggio di CO2 <i>CO2 Inflating cylinder</i> <i>Cylindre de gonflage de CO2</i>	1
3070132B	Raccordo di gonfiaggio per ciclo <i>Inflating connector for bicycle</i> <i>Raccord de gonflage pour bicyclette</i>	1
3070132C	Raccordo di gonfiaggio per moto/auto <i>Inflating connector for motorcycle/car</i> <i>Raccord de gonflage pour motocycle/voiture</i>	1



3070132A

3070132C

**Articoli vari per riparazioni - Different repairing items - Outils différents pour reparations**

<b>Codice</b> Code Code	<b>Descrizione</b> Description Description	<b>Rif.</b> Ref. Réf.	<b>Pz. / scatola</b> Pcs. / box Pcs. / boîte
3070133	Attrezzo a T con ago per vettura T handle tool c/w needle for car Outil à T avec aiguille pour tourisme	15-066	1
3070134	Ago di ricambio per vettura Spare needle for car Aiguille de rechange pour tourisme	15-067	1
3070135	Attrezzo a T con ago per autocarro T handle tool c/w needle for truck Outil à T avec aiguille pour camion	15-069	1
3070136	Ago di ricambio per autocarro Spare needle for truck Aiguille de rechange pour camion	15-070	1
3070138	Attrezzo ad ago universale Universal needle tool Outil avec aiguille universel	15-112	1
3070138A	Attrezzo ad ago universale lungo Long universal needle tool Outil avec aiguille universelle longue	15-113	1
3070139	Raspetta vettura / autocarro Car / truck probe rasp Râpe pour tourisme / camion	15-114	1
3070139C	Raspetta zigrinata Knurled probe Rape crénelée	-	1
3070139D	Attrezzo ad ago universale con impugnatura dritta Universal needle tool with straight handle Outil avec aiguille universel avec poignée droite	-	1
3070139E	Attrezzo ad ago automatico vettura/autocarro Car/truck automatic needle tool Outil automatique avec aiguille pour tourisme / camion	15-114	1
3070140	Attrezzo soluzionatore Cementing tool Outil pour le dissolutionnage	15-115	1
3070140A	Attrezzo ad ago per OTR/E.M. OTR/E.M. needle tool Outil avec aiguille pour OTR/G.C	-	1
3070140B	Ago di ricambio per OTR/E.M. (codice 3070140A) Spare needle for OTR /E.M. (code 3070140A) Aiguille de rechange pour OTR/G.C. (code 3070140A)	-	1
3070140C	Attrezzo ad ago per OTR/E.M. OTR/E.M. insert tool Outil avec aiguille pour OTR/G.C.	15-105	1
3070140D	Attrezzo soluzionatore per OTR/E.M. OTR/E.M. spiral cement tool Outil pour solution pour OTR/G.C.	15-107	1
3070141	Raschietto Scraper Racloir	42-620	1
3070141B	Raschietto con lama Blade style scraper Racloir avec lame	-	1
3070143	Rullino per riparazioni economico ø 40 x 4 Economical stitcher for repairs ø 40 x 4 Rouleau économ. pour réparations ø 40 x 4	-	1
3070144	Divaricatore manuale per pneumatici vettura Manual operated adjustable car tire spreader Écarte-pneu manuel tourisme	-	1
3070144B	Martello pneumatico per rappezzi Pneumatic stitcher for patches Marteau pneumatique pour emplâtres	31-683	1
3070144D	Spazzola in metallo con manico in plastica Wire brush with plastic handle Brosse en métal avec poignée en plastique	-	1





**MATERIALE AUTOVULCANIZZANTE PATCH RUBBER**  
**PATCH RUBBER SELF-CURING MATERIAL**  
**MATÉRIEL AUTOVULCANISANT PATCH RUBBER**

**Soluzione adesiva per riparazioni**  
**Cement for repairings**  
**Solution adhésive pour réparations**

Codice Code Code	Descrizione Description Description	Rif. Ref. Réf.	Pz. / scatola Pcs. / box Pcs. / boîte
3070145	Soluzione autovulcanizz. Fast-Dry da lt. 1 Fast-Dry self-curing cement (1 lt.) Solution autovulcanisante Fast-Dry (1 lt.)	16-450	6
3070146	Soluzione autovulcanizz. Fast-Dry da 200 cc. Fast-Dry self-curing cement (200 cc.) Solution autovulcanisante Fast-Dry (200 cc.)	16-451	12
3070146C	Soluzione autovulcanizz. Fast-Dry da 3,8 lt. (1 gallone) Fast-Dry self-curing cement 3,8 lt. (1 gallon) Solution autovulcanisante Fast-Dry 3,8 lt. (1 gallon)	16-452	4
3070147	Soluzione autovulcanizz. HV blu da 200 cc. HV blue self-curing cement (200 cc.) Solution autovulcanisante HV bleue (200 cc.)	16-460	12



3070145



3070147

**Sigillanti per talloni e riparazioni**  
**Bead and repair sealers**  
**Solutions pour talons et réparations**

Codice Code Code	Descrizione Description Description	Rif. Ref. Réf.	Pz. / scatola Pcs. / box Pcs. / boîte
3070150	Sigillante per talloni da lt 1 Bead sealer (1 lt) Solution adhésive pour talons (1 lt)	16-118	6
3070150A	Sigillante per talloni da lt 3,8 Bead sealer (3,8 lt) Solution adhésive pour talons (3,8 lt)	16-119	4
3070151	Sigillante per riparazioni da lt 0,5 Sealer for repairings (0,5 lt) Solution adhésive pour réparations (0,5 lt)	16-170	12
3070151A	Sigillante per riparazioni da lt 3,8 Sealer for repairings (3,8 lt) Solution adhésive pour réparations (3,8 lt)	16-171	4



3070150



3070151



3070151A

**Soluzioni per pulizia**  
**Cements for cleaning**  
**Solutions pour nettoyage**

Codice Code Code	Descrizione Description Description	Rif. Ref. Réf.	Pz. / scatola Pcs. / box Pcs. / boîte
3070154	Liquido buffer per pulizia da lt 1 Buffer liquid for cleaning (1 lt) Liquide buffer pour nettoyage (1 lt)	16-471	6
3070154A	Liquido buffer per pulizia da 3,8 lt (1 gallone) Buffer liquid for cleaning 3,8 lt (1 gallon) Liquide buffer pour nettoyage 3,8 lt (1 gallon)	16-472	4



3070154

# MATERIALE AUTOVULCANIZZANTE PATCH RUBBER

PATCH RUBBER SELF-CURING MATERIAL

MATÉRIEL AUTOVULCANISANT PATCH RUBBER

italmatic

## Utilizzo dei prodotti chimici nelle riparazioni pneumatici

Use of chemical products in tyre repairing

Utilisation des produits chimiques pour réparer les pneus



Fluido pulente

- Azione di pulizia rapida per un'adesione massima
- Elimina gli agenti contaminanti ed il polverino di rasatura
- Dissolve i lubrificanti per un'adesione sicura

Cleaner Fluid

- Fast-cleaning action for maximum adhesion
- Removes contaminants and buffing dust
- Dissolves lubricants for a secure bond

Fluide nettoyant

- Action de nettoyage rapide pour une adhésion maxima
- Il élimine les facteurs contaminants et la poudrette de râpage
- Il dissout les lubrifiants pour une adhésion sûre



Soluzione Fast Dry

- La soluzione ad asciugatura rapida accelera la procedura di riparazione
- Elimina i fallimenti nelle riparazioni dovuti ad un tempo di asciugatura incompleto
- Attiva il processo chimico che fa aderire le unità alla carcassa del pneumatico

Fast Dry Cement

- Fast-drying cement speeds repair process
- Eliminates failed repairs due to incomplete drying time
- Activates chemical process that bonds units to the tire casing

Solution Fast Dry

- La solution a séchage rapide accélère la procédure de réparation
- Elle élimine les défaillances des réparations dues à un temps de séchage incomplet
- Elle active le processus chimique qui fait adhérer les unités à la carcasse du pneu



Sigillante riparazioni

- Ripara i danni al bordo interno per prevenire perdite d'aria
- Si vulcanizza permanentemente – niente sfaldature o pelature
- Sigilla efficacemente le zone raspite in eccesso

Repair Sealer

- Repairs damaged innerliner to prevent air loss
- Permanently vulcanizes – no flaking or peeling
- Effectively seals overbuffed areas

Solution adhésive réparations

- Elle répare les dommages au bord intérieur afin de prévenir pertes d'air
- Elle se vulcanise d'une façon permanente – pas d'écailllements ou de pelage
- Elle scelle efficacement les zones râpées en excès



Sigillante talloni

- Uno stop rapido ed economico alle perdite tallone
- Forma una tenuta stagna tra pneumatico e cerchio
- Sigillante spesso, nero che viene steso facilmente con il pennello

Bead sealer

- Quick, economical end to bead leaks
- Forms airtight seal between the tire and rim
- Thick, black sealant brushes on smoothly

Solution adhésive talons

- Un arrêt rapide et économique aux pertes talon
- Elle forme une tenue étanche entre pneu et jante
- Solution épaisse, noire, qui est facilement étendue par le pinceau

# MATERIALE AUTOVULCANIZZANTE PATCH RUBBER

## PATCH RUBBER SELF-CURING MATERIAL

### MATÉRIEL AUTOVULCANISANT PATCH RUBBER

#### Anelli di montaggio per tubeless e OR per Movimento Terra

#### Mounting rings for tubeless and OR for E.M.

#### Anneaux de montage pour tubeless et OR pour P.L.

Codice Code Code	Descrizione Description Description	Misura in Pollici Size in inches Dimension en pouces	Ø corda mm Ø cord mm Ø corde mm
3070160	Anello montaggio tubeless PC 1 Mounting ring for tubeless PC 1 Anneau de montage pour tubeless PC 1	13" / 14"	-
3070161	Anello montaggio tubeless PC 2 Mounting ring for tubeless PC 2 Anneau de montage pour tubeless PC 2	14" / 15"	-
3070163	Anello montaggio tubeless Mounting ring for tubeless Anneau de montage pour tubeless	16,5" / 17,5"	-
3070164	Anello montaggio tubeless Mounting ring for tubeless Anneau de montage pour tubeless	19,5"	-
3070165	Anello montaggio tubeless Mounting ring for tubeless Anneau de montage pour tubeless	22,5" / 24,5"	-
3070168	Anello OR 25T/OR ring 25T/Anneau OR 25T	25"	6
3070169	Anello OR 325TOR ring 325T/Anneau OR 325T	25"	9
3070170	Anello OR 333T/OR ring 333T/Anneau OR 333T	33"	9

N.B. Altre misure disponibili su richiesta  
Other sizes available on request  
D'autres dimensions sont disponibles sur demande



#### Etichette per identificazione pneumatici

#### Tyre identification labels

#### Étiquettes pour identification pneus

Si applicano facilmente ed in modo permanente al pneumatico. Disponibili in varietà di colore, forma e dimensione, con marchi personalizzabili.

To be easily and permanently applied to any tyre. Available in a variety of colours, shapes and sizes with custom imprints.

On les applique facilement et d'une façon permanente au pneu. Disponibles en variété de couleur, forme et dimension, avec marques personnalisables.

Codice Code Code	Descrizione Description Description	Rif. Ref. Réf.	Pz. / scatola Pcs. / box Pcs. / boîte
3070400	Etichetta colorata (gialla, verde, blu) Coloured label (yellow, green, blue) Étiquette de couleur (jaune, vert, bleu)	12-242	500
3070401	Etichetta personalizzata Custom ID Decal Étiquette personnalisée	98-000	-
3070402	Etichetta "rear use only" "Rear use only" label Étiquette "Rear use only"	97-984	-

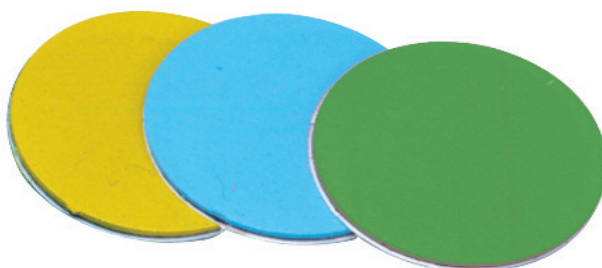

3070400



3070401



3070402

**Etichette RFID / RFID units / Étiquettes RFID**

Le unità RFID incorporano un microchip che consente la registrazione contemporanea del numero seriale, costruttore e prodotto nella stessa unità. Le informazioni possono essere lette e trasferite ad un PDA o un Personal Computer. E' la soluzione ideale per flotte commerciali, enti pubblici e per pneumatici avio.

*RFID units incorporate a microchip allowing the recording of serial, manufacturer and product numbers all in the same RFID. Information is read and transferred to a PDA or PC. Ideal for commercial fleets, government and aircraft tires.*

*Les unités RFID incorporent un microchip qui permet l'enregistrement contemporain du numéro sériel, constructeur et produit dans la même unité. Les renseignements peuvent être lu et transférés à un PDA ou à un Personal Computer. C'est la solution idéale pour flottes commerciales, organismes publiques et pour pneus avion.*

Codice Code Code	Descrizione Description Description	Rif. Ref. Réf.	Pz. / scatola Pcs. / box Pcs. / boîte
3070450	Dual cure RFID Dual cure RFID Dual cure RFID	98-274	10



3070450

**Etichette BarCode / BarCode units / Étiquettes BarCode**

Le unità "Tire Track" sono delle etichette permanenti contenenti un numero seriale univoco stampato come bar code per una lettura elettronica e in numeri per una lettura visiva. Fornito con un programma di analisi che supporta nell'elaborazione di statistiche e di report (es. statistiche danni agli pneumatici, performance del fornitore e del modello, ecc.)

*The "Tire Track" Unit is a permanent label containing a unique serial number that is engraved as a barcode that can be read electronically, and a corresponding eye-readable back-up. Delivered with a program ("Tire Track" System) supporting the elaboration of statistics and reports (e.g. statistic about tire failure causes, manufacturer and model performances, etc.)*

*Les unités "Tire Track" sont des étiquettes permanentes qui contiennent un numéro sériel univoque imprimé comme bar code pour une lecture électronique et en numéros pour une lecture visuelle. Fournies avec un programme d'analyse qui supporte en l'élaboration de statistiques et de rapports (ex. statistiques dommages aux pneus, performances du fournisseur et du modèle, etc.)*

Codice Code Code	Descrizione Description Description	Rif. Ref. Réf.	Pz. / scatola Pcs. / box Pcs. / boîte
3070500	Etichetta BarCode per sistemi di monitoraggio BarCode label for tire track system Étiquette BarCode pour systèmes de monitoring	-	-



3070500

**Pezze di bilanciatura pneumatici**  
**Balance Pads**  
**Tampons d'équilibrage**

Installare le pezze nell'area della corona del pneumatico per bilanciare gli pneumatici vettura, auto-carro e aeromobili. Ideale per pneumatici aereo, auto da corsa, fuoristrada 4x4.

*Install in the crown area for proper tire balance in passenger, truck and aircraft tires. Ideal for aircraft, racing cars, 4x4.*

*Installer les tampons sur la zone de la couronne du pneu pour équilibrer les pneus tourisme, camion et aéronefs. Idéal pour pneus avion, auto de course, tout-terrain 4x4.*

Codice Code Code	Peso gr. Weight gr. Poids gr.	Rif. Ref. Réf.	Pz. / scatola Pcs. / box Pcs. / boîte
3070600	15	97-501	100
3070601	30	97-503	100
3070602	45	97-504	100
3070603	60	97-505	100
3070604	70	97-506	100
3070605	85	97-507	100
3070606	100	97-508	100
3070607	115	97-509	100
3070608	130	97-510	100
3070609	140	97-511	100
3070610	170	97-512	50
3070611	200	97-513	50
3070612	230	97-514	50
3070613	260	97-515	50
3070614	285	97-516	50



3070601



3070602

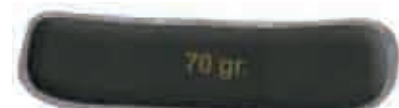

3070604



3070607

# MATERIALE AUTOVULCANIZZANTE PATCH RUBBER

## PATCH RUBBER SELF-CURING MATERIAL

## MATÉRIEL AUTOVULCANISANT PATCH RUBBER

### Applicazione riparazioni Bullseye a pneumatici vettura radiali

#### Radial passenger tire repair application

#### Application réparations pneus tourisme radiaux

Dimensione danno - Injury size - Dimension du dommage			
Danno spalla Shoulder injury Dommage épaule (S) mm	Danno corona Crown injury Dommage couronne (C) mm	Danno fianco Sidewall injury Dommage flanc	Usare riparazione BULL DC n° Use repair unit BUL DC n° Utiliser la réparation BUL DC n°
		Largh. x lunggh. Width x length Largeur x longueur mm x mm	
6	10	6 x 13	10
	20	15 x 30	14
6	6	6 x 15	10
	15	10 x 30	12
3	6	6 x 6	10
3	6	3 x 3	10
3	3		10

### Applicazione riparazioni Bullseye a pneumatici camion radiali

#### Radial truck tire repair application

#### Application réparations pneus camion radiaux

Dimensione danno Injury size - Dimension du dommage			Dimensioni pneumatici giganti Truck tire sizes Dimensions pneus camion		
Danno spalla Shoulder injury Dommage épaule (S) mm.	Danno corona Crown injury Dommage couronne (C) mm.	Danno fianco Sidewall injury Dommage flanc	6.00 - 7.50 7R - 8.5R 205/ - 225/	8.25 - 10.00 9R - 11R 11/ 235/ - 285/5	11.00 - 14.00 12R - 15.5R 12/ - 13/ 295/ - 385/
		Largh. x lunggh. Width x length Largeur x longueur mm x mm	usare riparazione BULL DC n° use repair unit BUL DC n° utiliser la réparation BUL DC n°		
3	6	3 x 3	10	10	10
6	10	10 x 10	12	12	12
10			20	20	20
	15		22	33*/40	33*/40
		1 cord x 38	20	20	20
		1 cord x 76	22	22	22
		1 cord x 121		24	24
		1 cord x 150		26	26
		2 cords x 19	20	20	20
		2 cords x 38	20	22	22
		2 cords x 64	22	24	24
		2 cords x 130		26	26
15			40	40	40
		10 x 40	22	26	40
		10 x 60	22	26	40
		10 x 80	26	26	42
		10 x 130		26	44
	20		33*/40	33*/40	35*/40
		15 x 40	22	40	40
		15 x 65	22	40	42
		15 x 100		42	44
		15 x 125		44	44
20				42	42
	25		33*/40	35*/42	35*/42
		20 x 25	22	40	42
		20 x 65	22	42	44
		20 x 100		42	44
		20 x 125		44	44
25				44	44
	40			37*/44	37*/44
		25 x 50	40	42	42
		25 x 75		42	44
		25 x 100		44	44
30					46
	40			37*/44	37*/44
		40 x 50		44	44
		40 x 75		44	44
		40 x 100		44	46

\* I bullseye 33, 35 e 37 sono solo per riparazioni corona.

\* The bullseye 33, 35 and 37 are for crown repairs only. \* Les bullseye 33, 35 et 37 sont seulement pour réparations de la couronne.

Danno corona (C)  
Crown injury (C)  
Dommage couronne (C)

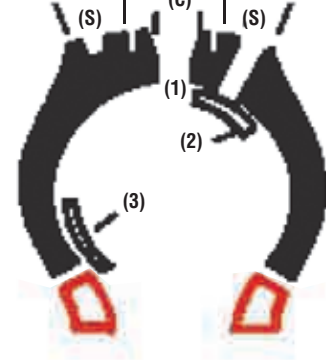

Danno spalla (S)  
Shoulder injury (S)  
Dommage épaule (S)

1) Danno corona: misurare il diametro max. della tela danneggiata.

Crown injury: measure max. diameter of damaged wire belt.

Dommage couronne: mesurer le diamètre max. de la toile endommagée.

2) Centrare l'unità di riparazione sul danno.

Center repair unit over injury.

Centrer la réparation sur le dommage.

3) Quando la centratura non è possibile, almeno il 25% della riparazione deve coprire il danno.

When centering is not possible, at least 25% of repair unit must extend beyond the injury.

Quand le centrage n'est pas possible, au moins 25% de la réparation doit couvrir le dommage.

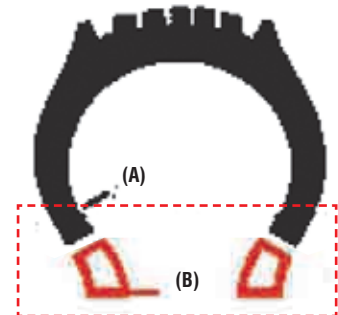

A - B Zona non riparabile

A - B Non-repairable area

A - B Zone non-réparable

Auto/Car/Voiture	40mm
7.00-8.75	65mm
9.00-14.00	75mm
16.00-18.00 (20.5-22.5)	90mm
21.00-29.5 (26.5-33.8)	125mm
30.00-33.00 (37.25-37.5)	150mm
36.00-UP	190mm

# MATERIALE AUTOVULCANIZZANTE PATCH RUBBER

PATCH RUBBER SELF-CURING MATERIAL

MATÉRIEL AUTOVULCANISANT PATCH RUBBER

italmatic

## Applicazione riparazioni Bullseye a pneumatici radiali OTR

OTR radial tyre Bullseye repair application

Application réparations Bullseye pneus P.L. radiaux

A	B	C	D	E
14.00-16.00, 15,5 17,5, 20, 20,5	18.00, 21.00, 23,5 26,5, 35/65, 40/65	24.00, 27.00, 29,5, 30.00 33,25, 33,5, 37,25, 37,5, 45	36.00 40.00	50.5

Dimensione danno  
Injury size - Dimension du dommage

Danno spalla "S" Shoulder injury "S" Dommage épaule "S" mm	Danno corona "C" Crown injury "C" Dommage couronne "C" mm	Danno fianco Sidewall injury Dommage flanc W x L mm	Dimensione pneumatico Tyre size Dimension pneu I   II   III   IV   V Utilizzare riparazione n° Use repair unit n° Utiliser réparation n°				
			I	II	III	IV	V
< 10	< 10		24	24	24	40	40
		10 x 65	24	24	24	42	42
		15 x 100	44	44	44	44	44
		20 x 75	44	44	44	44	44
	25	30 x 50	44	44	44	46	46
	25	Crown Repair Only	45	45	45	55	55
20			46	46	46	50	50
		20 x 150	46	46	46	46	46
		25 x 115	46	46	46	46	46
	40	40 x 75	46	46	46	50	50
	40	Crown Repair Only	45	45	55	55	55
		30 x 255	50	50	50	50	50
25			50	50	50	52	52
	50	50 x 205	50	50	50	52	52
	50	Crown Repair Only	55	55	55	65	65
		60 x 165	50	50	50	50	50
40			52	52	52	56	56
	65	50 x 255	52	52	52	56	56
	65	Crown Repair Only	55	55	65	65	75
50			52	52	52	56	60
		75 x 180	52	52	52	52	52
		100 x 125	52	52	52	52	52
		115 x 100	52	52	52	52	52
		50 x 355	56	56	56	56	56
		75 x 230	56	56	56	56	56
	75		56	56	56	60	60
	75	Crown Repair Only	65	65	65	75	75
65			56	56	56	60	60
		102 x 178	56	56	56	56	56
		114 x 152	56	56	56	56	56
		51 x 432	60	60	60	60	60
		76 x 279	60	60	60	60	60
	90		60	60	60	60	60
	90	Crown Repair Only	65	75	75	75	75
70			60	60	60	60	60
		100 x 205	60	60	60	60	60
		115 x 180	60	60	60	60	60
	100	Crown Repair Only	65	75	75	75	75
	114	Crown Repair Only	75	75	75	75	75
	127	Crown Repair Only	85	85	85	85	85
	140	Crown Repair Only	85	85	85	85	85

## Applicazione riparazioni Bullseye a pneumatici radiali trattore

Tractor radial tyre Bullseye repair application

Application réparations Bullseye pneus tracteur radiaux

DIMENSIONE DANNO - INJURY SIZE - DIMENSION DOMMAGE				
Danno spalla "S" Shoulder injury "S" Dommage épaule "S" mm	Danno corona "C" Crown injury "C" Dommage couronne "C" mm	Danno fianco Sidewall injury Dommage flanc W x L mm	Dimensione pneumatico Tyre size Dimension pneu 8.3-12.4   13.6-30.5 8-11   12-15 Utilizzare riparazione n° Use repair unit n° Utiliser réparation n°	
3	3	3 x 3	10	10
10	10	10 x 10	12	12
20			20	20
	20		20	20
		10 x 30	20	20
		20 x 30	22	80
		20 x 50	22	80
25			80	80
	40		80	82
		40 x 75	80	82
		50 x 50	80	82
		50 x 100	82	82
45			80	80
	65		82	82
		65 x 100	82	82
50			84	84
	90		82	82
		75 x 75	82	82
		75 x 125	82	84
		90 x 115	84	84
		100 x 100	84	84
75			86	86
	135		86	86
		100 x 150	86	86
		125 x 125	86	86
		150 x 100	86	86

### Nota importante / Important note / Note importante:

Le tabelle presentate rappresentano delle linee guida basate sulle attuali informazioni disponibili. Si raccomanda di consultare in dettaglio le indicazioni fornite dai costruttori di pneumatici. Si declina ogni responsabilità per errata riparazione del pneumatico ed eventuali danni.

The diagrams represent line guides based on the present information available. We recommend to consult in details the indications given by the tyre manufacturers. We decline any responsibility for wrong repairing of tyre and eventual damages.

Les schémas représentent des lignes guide basées sur les renseignements présents disponibles. On recommande de consulter en détails les indications données par les constructeurs de pneus. On décline toutes responsabilités pour réparation erronée du pneu et dommage éventuels.

Dal sito internet della Patch Rubber è possibile scaricare gratuitamente un'applicazione per identificare il tipo di rappazzo ideale per una specifica riparazione. Selezionando l'ubicazione e tipologia del danno, la dimensione e altri parametri, il programma propone il codice del rappazzo. ([www.patchrubber.com/tire\\_repair/configurator.html](http://www.patchrubber.com/tire_repair/configurator.html))

It is possible to unload free of charge from the web site of Patch Rubber an application to identify the ideal type of patch for a specific repairing. Selecting the position and type of damage, size and other parameters, the program proposes the code of the patch. ([www.patchrubber.com/tire\\_repair/configurator.html](http://www.patchrubber.com/tire_repair/configurator.html))

Il est possible de télécharger gratuitement par le site internet de Patch Rubber une application pour identifier le type d'emplâtre idéal pour une réparation spécifique. En sélectionnant la position et le type de dommage, la dimension et d'autres paramètres, le programme propose le code de l'emplâtre. ([www.patchrubber.com/tire\\_repair/configurator.html](http://www.patchrubber.com/tire_repair/configurator.html))

# MATERIALE AUTOVULCANIZZANTE PATCH RUBBER

## PATCH RUBBER SELF-CURING MATERIAL

## MATÉRIEL AUTOVULCANISANT PATCH RUBBER

**Applicazione riparazioni CX a pneumatici a tele diagonali OTR, giganti, vettura CX passenger, truck and OTR bias tire repair application**  
**Application réparations CX pneus P.L., camion, tourisme à toiles diagonales**

Dimensione danno Injury size Dimension dommage mm	Quantità tele pneumatico Tire ply rating Quantité de toiles du pneu							
	4Ply	6Ply	8Ply	10Ply	12Ply	14Ply	16Ply	18Ply
6	CX 2	CX 2	CX 2	CX 2	CX 2	CX 2	CX 3	CX 3
10	CX 2	CX 2	CX 2	CX 2	CX 2	CX 3	CX 4-2	CX 5-3
15	CX 3-2	CX 3-2	CX 3-2	CX 4-2	CX 4-2	CX 4-2	CX 5-3	CX 7-3
20	CX 4-2	CX 4-2	CX 4-2	CX 5-3	CX 5-3	CX 5-3	CX 6-4	CX 6-4
25	CX 5-3	CX 5-3	CX 5-3	CX 5-3	CX 6-4	CX 6-4	CX 8-4	CX 9-6
40	CX 5-3	CX 5-3	CX 7-3	CX 7-3	CX 6-4	CX 6-4	CX 9-6	CX 9-6
50	CX 7-3	CX 7-3	CX 6-4	CX 8-4	CX 9-6	CX 9-6	CX 12-6	CX 12-6
65	CX 8-4	CX 8-4	CX 8-4	CX 8-4	CX 9-6	CX 12-6	CX 15-6	CX 15-6
75			CX 9-6	CX 9-6	CX 12-6	CX 12-6	CX 16-8	CX 16-8
100				CX 15-6	CX 15-6	CX 15-6	CX 16-8	CX 16-8
125							CX 18-8	CX 18-8

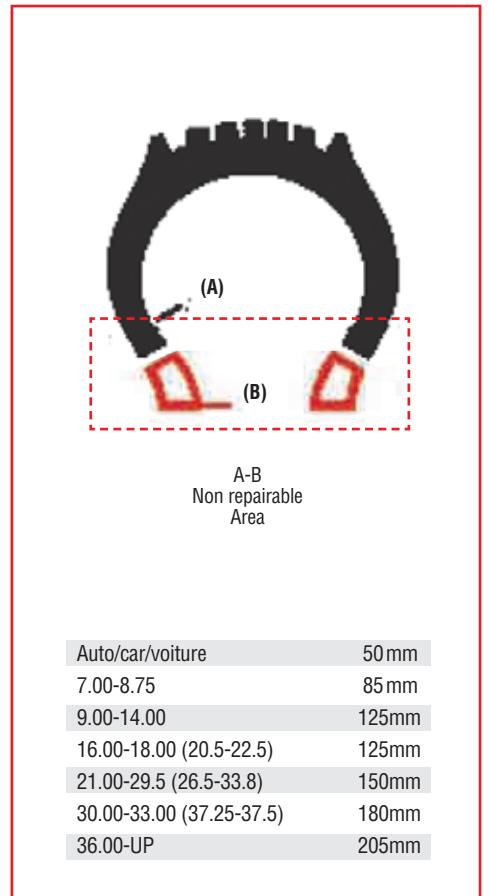

**Applicazione riparazioni CX a pneumatici a tele diagonali trattore CX tractor bias tire repair application**  
**Application réparations CX pneus tracteur à toiles diagonales**

Dimensione danno Injury size Dimension dommage mm	Quantità tele pneumatico Tire ply rating Quantité de toiles du pneu						
	4Ply	6Ply	8Ply	10Ply	12Ply	14Ply	16Ply
3	CX 1	CX 1	CX 1	CX 1	CX 2	CX 2	CX 3
6	CX 1	CX 1	CX 1	CX 1	CX 2	CX 2	CX 3
10	CX 3-2	CX 3-2	CX 3-2	CX 3-2	CX 3-2	CX 4-2	CX 4-2
15	CX 4-2	CX 4-2	CX 4-2	CX 4-2	CX 4-2	CX 4-2	CX 5-3
20	CX 4-2	CX 4-2	CX 6-2	CX 6-2	CX 7-3	CX 7-3	CX 6-4
25	CX 6-2	CX 6-2	CX 7-3	CX 7-3	CX 7-3	CX 7-3	CX 8-4
40	CX 7-3	CX 7-3	CX 8-4	CX 8-4	CX 8-4	CX 8-4	SDK 5
50	CX 7-3	CX 7-3	CX 8-4	CX 8-4	CX 9-6	CX 9-6	SDK 6
65	CX 8-4	CX 8-4	CX 9-6	CX 9-6	CX 9-6	CX 9-6	SDK 7
75	CX 8-4	CX 9-6	CX 9-6	SKD 1	SKD 5	SKD 5	SKD 8
100	CX 8-4	SKD 1	SKD 1	SKD 2	SKD 5	SKD 5	SKD 8
125	CX 10-4	SKD 1	SKD 1	SKD 2	SKD 6	SKD 7	HDSKD 6
150	SKD 2	SKD 2	SKD 2	SKD 3	SKD 6	SKD 7	HDSKD 6
180	SKD 2	SKD 2	SKD 2	SKD 3	SKD 7	SKD 8	HDSKD 7
205	SKD 3	SKD 3	SKD 3	SKD 3	SKD 7	SKD 8	HDSKD 8
230		SKD 4	SKD 4	SKD 4	SKD 8	HDSKD 9	HDSKD 9
255		SKD 4	SKD 4	SKD 4			HDSKD 9

**Applicazione riparazioni CX a pneumatici a tele diagonali E.M./OTR CX E.M. and OTR bias tire repair application**  
**Application réparations CX pneus P.L., OTR à toiles diagonales**

Dimensione danno Injury size Dimension dommage mm	Quantità tele pneumatico Tire ply rating Quantité de toiles du pneu											
	2-4	6-8	10-12	14-16	18-20	22-24	26-28	30-36	38-44	46-52	54-60	62&Over
15	4	4	4	4	4	6	6	6	6	6	6	8
25	4	6	6	6	6	6	6	6	6	8	8	10
40	4	6	6	6	6	6	8	8	8	8	8	10
50	4	6	6	8	8	8	8	8	8	10	10	12
65		6	6	8	8	8	10	10	10	12	12	14
75		6	8	10	10	10	10	10	12	14	14	14
100			8	10	10	10	13	12	12	14	14	16
125				10	10	12	14	14	16	16	16	16
150				12	12	12	14	14	16	16	18	18
180					12	14	14	16	16	18	18	18
205						14	16	18	18	18	18	18
230						16	16	18	18	20	20	20
255								18	18	20	20	20
280									20	20	20	20
305										20	20	20

**MATERIALE AUTOVULCANIZZANTE PATCH RUBBER**  
**PATCH RUBBER SELF-CURING MATERIAL**  
**MATÉRIEL AUTOVULCANISANT PATCH RUBBER**

italmatic



3080001



3080001A



3080001D



3080002



3080003B

**Materiale per riparazioni a caldo**  
**Material for hot repairs / Matériel pour réparations à chaud**

Codice Code Code	Descrizione Description Description	Larghezza Width Largeur	Peso kg Weight kg Poids kg	Rif. Ref. Réf.
3080001	Rotolo di para per riparazioni a caldo Para-rubber roll for hot repairs Rouleau de caoutchouc pour réparations à chaud	3 cm	1	-
3080001A	Rotolo di para per riparazioni a caldo Para-rubber roll for hot repairs Rouleau de caoutchouc pour réparations à chaud	22 cm	1	-
3080001B	Rotolo di para per riparazioni a caldo Patch Rubber Patch Rubber para-rubber roll for hot repairs Rouleau de caoutchouc pour réparations à chaud Patch Rubber	5 cm	14	18-198
3080001C	Rotolo di para per riparazioni a caldo Patch Rubber Patch Rubber para-rubber roll for hot repairs Rouleau de caoutchouc pour réparations à chaud Patch Rubber	15 cm	12	18-193
3080001D	Rotolo di para per riparazioni a caldo Patch Rubber Patch Rubber para-rubber roll for hot repairs Rouleau de caoutchouc pour réparations à chaud Patch Rubber	46 cm	5	18-201
3080002	Soluzione per riparazioni a caldo Cement for hot repairs Solution pour réparations à chaud	-	1	-
3080002A	Soluzione nera Patch Rubber per riparazioni a caldo 1 litro Patch Rubber black cement for hot repairs 1 litre Solution noire Patch Rubber pour réparations à chaud 1 litre	-	1	16-325
3080002B	Soluzione nera Patch Rubber per riparazioni a caldo 3,8 litri Patch rubber black cement for hot repairs 3,8 litres Solution noire Patch Rubber pour réparations à chaud 3,8 litres	-	4	16-326
3080003B	Soluzione nera Patch Rubber per riparazioni a caldo 18,9 litri Patch rubber black cement for hot repairs 18,9 litres Solution noire Patch Rubber pour réparations à chaud 18,9 litres	-	18	16-327



**PASTA MONTAGGIO PNEUMATICI**  
**PASTE TO MOUNT TYRES**  
**PÂTE POUR LE MONTAGE DES PNEUS**



3080005



3080006



3080005N



3080005S



3080008A

Codice Code Code	Descrizione Description Description	Note Notes Notes	Peso kg Weight kg Poids kg
3080004	Pasta montaggio pneumatici moto/vettura Paste to mount motorcycle/car tyres Pâte pour le montage des pneus moto/tourisme	Bianca White Blanche	1
3080005	Pasta montaggio pneumatici moto/vettura Paste to mount motorcycle/car tyres Pâte pour le montage des pneus moto/tourisme	Bianca White Blanche	4
3080005B	Pasta montaggio pneumatici moto/vettura Paste to mount motorcycle/car tyres Pâte pour le montage des pneus moto/tourisme	Bianca White Blanche	5
3080005C	Pasta spray Patch Rubber "Spray-N-Mount" (46-248) Patch Rubber "Spray-N-Mount" spray paste (46-248) Pâte à être vaporisée Patch Rubber "Spray-N-Mount" (46-248)	Spray	1
3080005D	Pasta spray Socolub montaggio pneumatici moto/auto Spray paste Socolub to mount motorcycle/car tyres Pâte spray Socolub pour le montage de pneus motorcycle/tourisme	Spray	0,4
3080005L	Pasta montaggio pneumatici moto/vettura Paste to mount motorcycle/car tyres Pâte pour le montage de pneus moto/tourisme	Nera Black Noire	1
3080005N	Pasta montaggio pneumatici moto/vettura Paste to mount motorcycle/car tyres Pâte pour le montage des pneus moto/tourisme	Nera Black Noire	5
3080005S	Pasta montaggio ad alte prestazioni indicata per pneumatici sportivi e runflat High performance mounting paste suggested for sport and runflat tyres Pâte haute performance suggérée pour le montage des pneus sportifs et runflat	Azzurra Light blue Azur	5
3080006	Grasso montaggio pneumatici autocarro Grease to mount truck tyres - Graisse pour le montage des pneus camion	Giallo Yellow / Jaune	4

**PASTA MONTAGGIO PNEUMATICI**  
**PASTE TO MOUNT TYRES**  
**PÂTE POUR LE MONTAGE DES PNEUS**

italmatic



3080008C



3080007



3080005D



3080005C



3080009



3080009A



3080009B



3080009C

Codice Code Code	Descrizione Description Description	Note Notes Notes	Peso kg Weight kg Poids kg
3080006B	Grasso montaggio pneumatici autocarro Grease to mount truck tyres Graisse pour le montage des pneus camion	Giallo Yellow Jaune	5
3080007	Grasso Tigre Michelin per pneum. autocarro Michelin Tigre grease for truck tyres - Graisse Tigre Michelin pour pneus camion	Giallo Yellow / Jaune	4
3080008A	Grasso speciale montaggio pneumatici grosso autocarro, trattore e gomme piene Special grease to mount big truck, tractors and solid tyres Graisse spéciale pour le montage des pneus pour grand camion, tracteur et pneus pleins	Rosso Red Rouge	5
3080008C	Super lubrificante liquido per montaggio Patch Rubber (46-250) (si può diluire in acqua o usare concentrato) - per tutti gli pneumatici Patch Rubber liquid super lubricator for mounting (46-250) (it can be diluted into water or used concentrated) - for all types of tyres Super lubrifiant liquide pour montage Patch Rubber (46-250) (il peut être dilué dans l'eau ou utilisé concentré) - pour tous les pneus	Trasparente Transparent Transparent	4
3080009	Pennello ø 30 per pasta e grasso in plastica - Plastic brush ø 30 for paste and grease Pinceau en plastique ø 30 pour pâte et graisse	-	-
3080009A	Pennello ø 30 per pasta e grasso in legno - Wood brush ø 30 for paste and grease Pinceau en bois ø 30 pour pâte et graisse	-	-
3080009B	Pennello in legno ricurvo per pasta e grasso Bent wooden brush for paste and grease Pinceau en bois recourbé pour pâte et graisse	-	-
3080009C	Tampone per applicazione lubrificante liquido montaggio 3080008C Pad to apply the liquid lubricator for mounting 3080008C Tampon pour application lubrifiant liquide montage 3080008C	-	-

**Porta gessi**  
**Chalks holder**  
**Porte-craie**

Codice Code Code	Descrizione Description Description
3080018	Porta gessi in metallo per gessi Ø 14 mm. Metal chalks holder for chalks Ø 14 mm. Porte-craie en métal poue craies Ø 14 mm.



3080018

**Gessi e pennarelli per pneumatici**  
**Chalks and marking pens for tyres**  
**Craies et stylos de marquage pour pneus**

Codice Code Code	Descrizione Description Description	Ø mm Ø mm Ø mm	Pz. / scatola Pcs. / box Pcs. / boîte
3080020	Scatola gessi bianchi per gomma Box of white chalks for rubber / Boîte de craies blanches pour caoutchouc	14	12
3080021G	Scatola gessi gialli per gomma Box of yellow chalks for rubber / Boîte de craies jaunes pour caoutchouc	14	12
3080021R	Scatola gessi rossi per gomma Box of red chalks for rubber / Boîte de craies rouges pour caoutchouc	14	12
3080021V	Scatola gessi verdi per gomma Box of green chalks for rubber / Boîte de craies vertes pour caoutchouc	14	12
3080022	Scatola gessi bianchi per gomma Box of white chalks for rubber / Boîte de craies blanches pour caoutchouc	18	72
3080023G	Scatola gessi gialli per gomma Box of yellow chalks for rubber / Boîte de craies jaunes pour caoutchouc	18	72
3080023R	Scatola gessi rossi per gomma Box of red chalks for rubber / Boîte de craies rouges pour caoutchouc	18	72
3080023V	Scatola gessi verdi per gomma Box of green chalks for rubber / Boîte de craies vertes pour caoutchouc	18	72
3080024	Pennarello per pneumatici bianco White marking pen for tyres / Stylo de marquage blanc pour pneus	-	1
3080024A	Pennarello per pneumatici argento Silver marking pen for tyres / Stylo de marquage argent pour pneus	-	1



3080024

**Vernice in tubetto e bastoncini**  
**Paint in tube and sticks**  
**Peinture en tube et bâtons**

Codice Code Code	Caratteristiche Features Caractéristiques
3080025	Vernice opaca e visibile, marca su tutte le superfici, anche unte o grasse. Elevata resistenza ai raggi UV. Matt and visible paint, it marks on all surfaces, even oily or greasy. High resistance to UV rays. Peinture opaque et visible, elle marque sur toutes surfaces, même grasses et huileuses. Élevée résistance aux rayons UV.
3080025A	Stick di vernice bianca ottima marcatura su superfici umide, unte e oleose. Indelebile. White paint stick, excellent marking on moist, greasy and oily surfaces. Indelible. Bâton de peinture blanche, marquage excellent sur surfaces humides, grasses et huileuses. Indelible.
3080025B	Stick di vernice gialla ottima marcatura su superfici umide, unte e oleose. Indelebile. Yellow paint stick, excellent marking on moist, greasy and oily surfaces. Indelible. Bâton de peinture jaune, marquage excellent sur surfaces humides, grasses et huileuses. Indelible.



3080025



3080025B

**Spray sbloccanti e pulitore freni e colla**  
**Unlocking spray and cleaner for brakes and glue**  
**Vaporisateur débloquant et polisseur pour freins et colle**

Codice Code Code	Descrizione Description Description	Confezione da lt Box of lt Conditionnement de lt
3080027	Sviting spray a norme CE Sviting spray according to E.C. rules Vaporisateur Sviting selon les dispositions C.E.	lt 0,4
3080027C	Grasso ceramico spray. Effetto sbloccante e anti corrosivo Ceramic spray grease. Unlocking and anti-corrosion effect Graisse céramique en vaporisateur. Effet débloquant et anticorrosion	lt 0,4
3080028C	Pulitore per freni e colla - Professionale Cleaner for brakes and glue - Professional Polisseur pour freins et colle - Professionnel	lt 0,6



3080027



3080027C



3080028C



3080028A



3080029

**Pulitori e lucidanti per pneumatici e cerchi**  
**Cleaners and polish for tyre and wheel**  
**Polisseur-cireurs pour pneus et jantes**

3080028A	Pulitore-lucidante per tutti i tipi di cerchi Cleaner-polish for any kind of rim Polisseur-cireur pour tous types de jantes	lt 0,5
3080029	Puligomma ravnivante. Pulisce e protegge i pneumatici Renewing tyre. It cleans and protects tyres Renovateur. Il nettoie et protège les pneus	lt 0,5
3080030	"NO TOUCH" WET'N PROTECT. Pulisce e protegge i pneumatici con effetto "bagnato" "NO TOUCH" WET'N PROTECT. It cleans and protects tyres with "wet" effect "NO TOUCH" WET'N PROTECT. Il nettoie et protège les pneus avec effet "mouillé"	lt 0,5



3080030

**Rilevatore forature**  
**Puncture leaks detector**  
**Détecteurs de pertes**

3080033	Rilevatore perdite da foratura (65454-67) Puncture leaks detector (65454-67) Détecteur de pertes dû à crevaisons (65454-67)	lt 0,5
3080033A	Vaporizzatore per 3080033 Sprayer for 3080033 Vaporisateur pour 3080033	—
3080033C	Rilevatore concentrato perdite da forature 0,7 lt (1/4 gallone) Patch Rubber 46-617 Concentrated puncture leaks detector 0,7 lt (1/4 gallon) Patch Rubber 46-617 Détecteur concentré de pertes du à crevaisons 0,7 lt (1/4 gallon) Patch Rubber 46-617	lt 0,7
3080033D	Rilevatore concentrato perdite da forature 3,8 lt (1 gallone) Patch Rubber 46-618 Concentrated puncture leaks detector 3,8 lt (1 gallon) Patch Rubber 46-618 Détecteur concentré de pertes du à crevaisons 3,8 lt (1 gallon) Patch Rubber 46-618	lt 3,8



3080033



3080033A



3080033D

**ARTICOLI VARI**  
**DIFFERENT ITEMS**  
**ARTICLES DIFFÉRENTS**



3080034



3080034B



3080035



3080036

**Prodotti per riparazioni d'emergenza**  
**Products for emergency repairing**  
**Produits pour réparation d'emergence**

Codice Code Code	Descrizione Description Description	Confezione da lt Box of lt Conditionnement de lt
3080034	Gonfia e ripara pneumatici per auto e moto, con e senza camera d'aria Inflator and repairer for car and motorcycle tyres, with and without air tube Gonfle et répare-pneus pour voiture et motocycle, avec ou sans chambre à air.	lt 0,3
3080034B	Gonfia e ripara pneumatici per SUV e caravan, con e senza camera d'aria Inflator and repairer for SUV and caravan, with and without air tube Gonfle et répare-pneus pour SUV et caravan, avec ou sans chambre à air.	lt 0,4
3080035	Kit riparazione pneumatici Pump&Go con compressore e sigillante. Ripara fori fino ad un massimo di 10mm. Composto da compressore 12 V - 300 psi e 500 ml di sigillante Tyre repairing kit Pump&Go with compressor and sealer. It repairs holes up to a max. of 10 mm. Consisting of compressor 12 V - 300 psi and 500 ml of sealer Kit réparation pneus Pump&Go avec compresseur et solution adhésive. Il répare crevaisons jusqu'à un max. de 10mm. Composé par compresseur 12 V - 300 psi et 500 ml de solution adhésive	-
3080035B	Sigillante di ricambio 500ml per 3080035 Spare sealer 500ml pour 3080035 Solution adhésive de rechange 500 ml pour 3080035	lt 0,5
3080036	Mini compressore Air Max 12V - 10 bar - 22 l/min, adatto anche a pneumatici di grandi dimensioni. Cavo alimentazione 3 metri. In dotazione 2 adattatori per gonfiabili ed ago gonfia palloni Mini compressor Air Max 12V - 10 bar - 22 l/min, suitable also for tyres of big sizes. Feeding cable 3 meters. Equipped with 2 adaptors for inflatable devices and needle to inflate balloons Mini compresseur Air Max 12V - 10 bar - 22 l/min, indiqué aussi pour pneus de grandes dimensions. Câble d'alimentation 3 mètres. Equipé de 2 adaptateurs pour dispositifs gonflables et aiguille gonfle ballons	-

**Rotoli di carta - Paper on reel - Papier sur bobine**

Codice Code Code	Descrizione Description Description
3080040	Rotolo di carta doppio velo mille usi 200 m Microglued webs paper on reel for all uses 200 m Papier sur bobine à 2 voiles microcollés pour tous usages 200 m
3080041	Rotolo di carta 2 veli microcollati - 800 strappi/296 m 2 microglued webs paper on reel - 800 tears/296 m Papier sur bobine à 2 voiles microcollés - 800 accrocs/296 m
3080042	Cavalletto porta rotoli a terra in metallo Floor metal reel stand / Chevalet en métal au sol pour bobine
3080042A	Porta rotoli a muro in metallo / Wall metal reel stand / Support en métal au mur pour bobine



3080040



3080042

**Protezioni per interni - Protections for interior compartments - Protections pour habitacles**

Codice Code Code	Descrizione Description Description	Pz. / scatola Pcs. / box Pcs. / boîte
3080050	Bobina coprisedile da 250 strappi - neutra Seat cover reel of 250 tearings - neutral Rouleau housses de siège - 250 accrocs - neutre	1
3080052	Bobina copritappetini da 250 strappi (cm 37,5 x 50) Matting cover reel of 250 tearings (cm 37,5 x 50) Rouleau protège-tapis - 250 accrocs (cm 37,5 x 50)	1
3080054	Bobina coprivolante con manopola Steering wheel cover reel with handle Rouleau protège-volant avec poignée	4
3080056	Kit protezione standard comprendente: 1 bobina coprisedile + 1 bobina copritappetini + 1 bobina coprivolante con manopola + 1 supporto da parete Standard protection kit including: 1 seat cover reel + 1 matting cover reel + 1 steering wheel cover reel with handle + 1 wall rest Kit de protection standard incluant: 1 rouleau housses de siège + 1 rouleau protège-tapis + 1 rouleau protège-volant avec poignée + 1 dévidoir mural	1
3080057	Kit protezione 5 in 1 da 100 pezzi: 1 protezione tappetino; 1 protezione sedile; 1 protezione volante; 1 protezione leva cambio; 1 protezione leva freno a mano Protection kit 5 in 1 of 100 pieces: 1 matting cover; 1 seat cover; 1 steering wheel cover; 1 speed gear lever cover; 1 hand brake lever cover Kit de protection 5 en 1 à 100 pièces: 1 protège-tapis; 1 protège-siège; 1 protège-volant; 1 protège-levier du changement de vitesse; 1 protège-levier du frein à main	1
3080057B	Supporto a parete per kit 3080057 Wall support for kit 3080057 Support mural pour kit 3080057	1
3080057H	Rotolo di set protezione leva cambio e freno a mano da 250 coppie Reel of protection set for speed gear lever and hand brake of 250 pairs Bobine de kits de protection levier du changement de vitesse et frein à main à 250 paires	1



3080050



3080052



3080054



3080056



3080057



3080057B



3080057H

**Sacchi porta ruota - Tyre containing bags - Sacs porte pneus**

Codice Code Code	Descrizione Description Description	Pz. / scatola Pcs. / box Pcs. / boîte
3080061	Bobina 100 sacchi ruota 25 micron (70+15+15x100) Reel of 100 bags for tyres 25 micron (70+15+15x100) Bobine à 100 sacs porte pneus 25 micron (70+15+15x100)	
3080061D	Espositore a muro metallico per sacchi ruota Wall metal dispenser for tyre bags Expositeur métallique mural pour sacs pneus	



3080061D



3080061

# STALLONATORI BEAD BREAKERS DÉTALONNEURS

3080085



3080086C



3080086E



3080086H



3080086



3080086D



3080087



3080087B

## Stallonatori idraulici portatili Portable hydraulic bead breakers Détalonneurs portables hydrauliques

Codice Code Code	Descrizione Description Description	Note Notes Notes	Peso kg Weight kg Poids kg
3080085	Stallonatore idraulico con prolunga calamitata di 2 cm Hydraulic bead breaker with 2 cm extension with magnet Détalonneur hydraulique avec rallonge avec aimant 2 cm	Per pneumatici vettura, fuori strada e trattori. Corsa del pistone 4 cm For car, off the road, tractor tyres. 4 cm piston stroke Pour pneus voiture, 4x4, tracteur. Course du piston 4 cm	5
3080086	Stallonatore idraulico M.T. con prolunghe calamitate Hydraulic E.M. bead breaker with extensions with magnet Détalonneur hydraulique pour pneus G.C. avec rallonges avec aimant	Per tallone interno di pneumatici M.T. da 25" a 51" su cerchi di 5 pezzi For inside bead of E.M. tyres from 25" to 51" on rims of 5 pieces Pour talon intérieur de pneus G.C. de 25" à 51" sur jantes à 5 pièces	4
3080086C	Stallonatore idraulico M.T. con forche di 8 cm e 2 uncini da 7,5 e 10 cm in acciaio speciale Hydraulic E.M. bead breaker with forks 8 cm and 2 hooks of 7,5 and 10 cm in special steel Détalonneur hydraulique pour pneus G.C. avec fourches 8 cm et 2 crochets à 7,5 et 10 cm en acier spécial	Per tallone interno ed esterno di pneumatici M.T. da 25" a 51" su cerchi di 5 pezzi completo di raccordo girevole brevettato For inside and outside bead of E.M. tyres from 25" to 51" on rims of 5 pieces complete with patented rotary connector Pour talon intérieur et extérieur de pneus G.C. de 25" à 51" sur jantes à 5 pièces complet de raccord tournant breveté	7
3080086D	Stallonatore idraulico M.T. con piedini e paletta da 10 cm e potenza kg 5.500 Hydraulic E.M. bead breaker with feet and 10 cm blade, power 5.500 kg Détalonneur hydraulique pour pneus G.C. avec pieds et aube à 10 cm, puissance 5.500 kg	Essenziale per pneumatici M.T. fino 29" su cerchi di 3 pezzi (es. Caterpillar 962G, 924G, Volvo L120) - Necessita 3080087B Essential for E.M. tyres up to 29" on rims of 3 pieces (ex. Caterpillar 962G, 924G, Volvo L120) - Needs also 3080087B Essentiel pour pneus G.C. jusqu'à 29" sur jantes à 3 pièces (ex. Caterpillar 962G, 924G, Volvo L120) - Nécessite de 3080087B	15
3080086E	Stallonatore idraulico camion potenza kg 10.000 Hydraulic truck bead breaker, power 10.000 kg Détalonneur hydraulique pour pneus camion puissance 10.000 kg	Essenziale per cerchi Actros ed Alcoa Essential for Actros and Alcoa rims Essentiel pour jantes Actros et Alcoa	20
3080086H	Stallonatore pneumatico universale per pneumatici tubeless camion, trattore, OTR Universal, pneumatic bead breaker for tubeless truck, tractor and OTR tyres Détalonneur pneumatique, universel pour pneus tubeless camion, tracteur, OTR	Disegno compatto - non necessita di parti opzionali (solo aria compressa) Compact design - no additional parts needed (only compressed air) Dessin compacte - il ne nécessite pas de parties optionnelles (seulement air comprimé)	--
3080087	Pompa pneumo-idraulica a pedale - 700 bar in uscita Pedal hydro-pneumatic pump - outlet 700 bar Pompe hydro-pneumatique à pédale - sortie 700 bar	Con tubo flessibile di 3 m ed innesto rapido. Pressione minima di entrata 8-10 bar With flexible hose 3 m long and quick connector. Minimum inlet pressure 8-10 bar Avec tuyau flexible à 3 m et raccord rapide. Pression minimum d'entrée 8-10 bar	10
3080087B	Pompa idraulica manuale con pedale - 700 bar in uscita Manual pedal hydraulic pump - outlet 700 bar Pompe hydraulique manuelle à pédale - sortie 700 bar	Con tubo flessibile di 3 m ed innesto rapido With flexible hose 3 m long and quick connector Avec tuyau flexible à 3 m et raccord rapide	10



3080080



3080080B



3080080C



3080080E

**Kit Bead Booster - Bead Booster kit - Kit Bead Booster**

Codice Code Code	Descrizione Description Description
3080080	Sistema manuale 19, peso 15 kg Manual system 19, weight 15 kg / Système manuel 19, poids 15 kg
3080080B	Bead Booster Bazooka 6lt Bazooka bead booster 6lt / Bead booster Bazooka 6lt
3080080C	Bead Booster Bazooka 9lt per pneumatici camion Bazooka bead booster 9lt for truck tyres / Bead booster Bazooka 9lt pour pneus camion
3080080E	Stazione di carica Bead Booster Bazooka Bead Booster Bazooka charge station / Bead booster Bazooka station de charge

**Tagliacoperture**

**Tire cutter**

**Machine à découper les pneus**

Codice Code Code	Descrizione Description Description
3080090	Taglia copertura e taglia talloni Tire and bead cutter Machine à découper les pneus et le talon
3080090A	Lama taglia coperture Blade for tire cutter Lame pour machine à découper les pneus
3080090B	Lama taglia talloni Blade for bead cutter Lame pour machine à découper les talons
3080090T	Vasca per stoccaggio coperture tagliate facilita carico e scarico pneumatici tagliati (2000x1280x1400h) Box to stock cut tyres, it makes the cut tyres loading and unloading easier (2000x1280x1400h) Caisse de stockage pneus coupés, elle rend le chargement et déchargement des pneus coupés plus facile (2000x1280x1400h)

3080090



3080090T



**Vasche prova pneumatici**

**Tyre test tanks**

**Cuves pour essai pneus**

Codice Code Code	Descrizione Description Description
3080092	Vasca prova pneumatici fino a 24" con recipiente in vetroresina Tyre test tank up to 24" with container in fiberglass-reinforced plastic Cuve pour essai pneus jusqu'à 24" avec récipient en verre résine

3080092





**Gabbia di sicurezza a norme CE**  
**Safety cage according to EC rules**  
**Cage de sécurité selon dispositions CE**

Codice Code Code	Descrizione Description Description	Dimensioni Sizes Dimensions
3080095	Garantisce la max. sicurezza nella fase di montaggio dei pneumatici fino ad un ø di 1500 mm Completo di kit pistola Michelin <i>It warrants max. safety while mounting tyres up to a ø of 1500 mm</i> <i>Complete with Michelin gun kit</i> <i>Elle garantit la sécurité max. pendant le montage de pneus jusqu'à un ø de 1500 mm</i> <i>Complète de kit pistolet Michelin</i>	1550x1600x800 mm
3080096	Kit gonfiatubeless <i>Tubeless inflator kit</i> <i>Kit gonfle tubeless</i>	



3080095

**Tavolo di gonfiaggio pneumatici con gabbia di sicurezza**  
**Table for tyre inflation with safety cage**  
**Table de gonflage pneus avec cage de sécurité**

Codice Code Code	Descrizione Description Description
3080101	Tavolo di supporto per gonfiaggio pneumatici con rulli di scorrimento e gabbia di sicurezza. Completo di supporto elastico per pistola di gonfiaggio. <i>Support table for tyre inflation with sliding rollers and safety cage. Complete with elastic support for inflating gun.</i> <i>Table de support pour gonflage pneus avec rouleaux de glissement et cage de sécurité. Complet de support élastique pour pistolet de gonflage.</i>



3080101

**Divaricatore per pneumatici - Tyre spreader - Écarte-pneus**

Codice Code Code	Descrizione Description Description
3080103	Divaricatore pneumatici con supporto per pneumatici vettura e veicoli commerciali. <i>Tyre spreader with holder for car and commercial vehicles tyres.</i> <i>Écarte-pneus avec support pour pneus tourisme et véhicules commerciaux</i>
3080103B	Luce di ispezione per divaricatore pneumatici 3080103 <i>Inspection lamp for tyre spreader 3080103</i> <i>Lampe d'inspection pour écarte-pneus 3080103</i>



3080103

3080103B

**Sollevatore pneumatici**  
**Tyre lifter**  
**Élévateur pour pneus**

Codice Code Code	Descrizione Description Description
3080108	Sollevatore per pneumatici semi-automatico (H: 530 mm - Largh: 430 mm - Lung: 1000 mm) (altezza di sollevamento max. 700) <i>Semi - automatic tyre lifter ( H: 530 mm - W: 430 mm - L: 1000 mm)</i> <i>(lifting height max. 700 mm)</i> <i>Élévateur pour pneus semi-automatique (H: 530 mm - Largeur: 430 mm - Longueur: 1000 mm) (hauteur de soulèvement max. 700 mm)</i>



3080108



3080105



3080105A



3080105H



3080105B



3080105D

**Carrelli per pneumatici**  
**Trolleys for tyres moving**  
**Chariots pour le mouvement des pneus**

<b>Codice</b> Code Code	<b>Descrizione</b> Description Description
<b>3080105</b>	Carrello trasporta pneumatici - portata massima 200 Kg (4 cerchi completi o 8 pneumatici). <i>Trolley for tyres moving - max. capacity 200 Kg</i> (4 complete rims or 8 tyres) <i>Chariot pour le mouvement des pneus - capacité max. 200 Kg</i> (4 jantes complètes ou 8 pneus)
<b>3080105A</b>	Carrello trasporta pneumatici con due ruote fisse e due ruote pivotanti portata massima 150kg <i>Trolley for tyres moving with 2 fix wheels and two pivoting wheels</i> max. capacity 150kg <i>Chariot pour le mouvement des pneus avec deux roues fixes et deux</i> <i>roues pivotantes - capacité max. 150kg</i>
<b>3080105B</b>	Carrello trasporta pneumatici economico (cm 170 x 60) <i>Economic trolley for tyres moving (cm 150 x 60)</i> <i>Chariot économique pour le mouvement des pneus (cm 150 x 60)</i>
<b>3080105D</b>	Carrellino porta pneumatici impilabile - Ø630mm / max 120kg <i>Stackable wheel trolley - Ø630mm / max 120kg</i> <i>Chariot porte pneus empilable - Ø630mm / max 120kg</i>
<b>3080105H</b>	Carrello centraruota ideale per montaggio su veicoli industriali per pneumatici da 6,5" a 22,5" <i>Wheel centering trolley, ideal to be mounted on industrial vehicles for tyres</i> <i>from 6.5" to 22.5"</i> <i>Chariot centre roue, idéal pour montage sur véhicules industriels pour</i> <i>pneus de 6.5" à 22.5"</i>
<b>3080106D</b>	Scaffalatura mobile pneumatici 160cm <i>Mobile shelving for tyres 160cm</i> <i>Rayons mobiles pour pneus 160cm</i>



3080106D



3080110



3080110C

**Cassettiere porta attrezzi, pesi, minuterie**  
**Chests of drawers for tools, weights, nuts and bolts**  
**Tiroirs porte outils, masses, menuiseries**

<b>Codice</b> Code Code	<b>Descrizione</b> Description Description
<b>3080110</b>	Porta pesi e minuterie (a muro) con 19 cassetti basculanti (107x22x20) Holder for weights, nuts and bolts (on the wall) with 19 tilting drawers (107x22x20) Porte masses et menuiseries (mural) avec 19 tiroirs basculants (107x22x20)
<b>3080110C</b>	Porta pesi e minuterie (carrellato) con 19 cassetti basculanti e porta rotolo carta (170x36x50) Holder for weights, nuts and bolts (on trolley) with 19 tilting drawers and paper roll holder (170x36x50) Porte masses et menuiseries (sur chariot) avec 19 tiroirs basculants (170x36x50)
<b>3080110E</b>	Carrello Sprinter portautensili in lamiera di acciaio con 7 cassetti. Portata 45kg a cassetto. Dimensione 680x460x860h Sprinter Trolley for tools in steel plate with 7 drawers. Capacity 45kg each drawer. Dimension 680x460x860h Chariot Sprinter porte outils en tôle d'acier avec 7 tiroirs. Capacité 45kg chacun tiroir. Dimension 680x460x860h



3080110E



**Cavalletto a pedana porta moto**  
**Board stand to hold motorcycles**  
**Chevalet à tremplin porte motocycles**

<b>Codice</b> Code Code	<b>Descrizione</b> Description Description
<b>3080113</b>	Cavalletto bloccaruota moto con sollevatore incorporato <i>Motorcycle wheel locking stand with lifter incorporated</i> <i>Chevalet bloqué roue motorcycles avec releveur incorporé</i>
<b>3080113B</b>	Pedana mobile parcheggia moto. Predisposta per assemblaggio con cavalletto blocca ruota <i>Mobile board to park motorcycles. Preset to be assembled with wheel locking stand</i> <i>Tremplin mobile pour parquer le motorcycle. Prédisposé pour assemblage avec chevalet bloqué roue</i>
<b>3080113D</b>	Cavalletto alzamoto per asse anteriore e posteriore. Utile per operazioni che richiedono le ruote libere <i>Motorcycle lifting stand for front and back axle. Useful for operations requiring free wheels</i> <i>Chevalet pour soulever le motorcycle pour axe antérieur et postérieur. Utile pour opérations à faire avec roues libres</i>
<b>3080113F</b>	Cavalletto alzamoto per asse posteriore. Utile per forcellone monobraccio <i>Motorcycle lifting stand for back axle. Useful for single arm fork</i> <i>Chevalet pour soulever le motorcycle pour axe postérieur. Utile pour fourche monobras</i>
<b>3080113H</b>	Sollevatore idraulico per motociclette 680kg. Per motocicli con sottotelaio. Altezza min 145 / max 420mm; altezza sollevamento 375mm; dimensioni 865 x 360 x 325 mm <i>Hydraulic lifter for motorcycles 680kg. For motorcycles with subframe.</i> <i>Height min. 145 / max. 420mm; lifting height 375mm; sizes 865 x 360 x 325 mm</i> <i>Souleveur hydraulique pour motocycles 680kg. Pour motocycles avec sous-châssis. Hauteur min. 145 / max. 420mm;</i> <i>hauteur de soulèvement 375mm ; dimensions 865 x 360 x 325 mm</i>





3080114



3080114B

**Lettoino carrellato da officina**  
**Trolley table for workshop**  
**Table à chariot pour usine**

Codice Code Code	Descrizione Description Description
3080114	Carrellino da officina in plastica 6 rotelle pivotanti, con porta attrezzi laterale e poggiatesta imbottito <i>Workshop plastic trolley with 6 pivoting wheels, lateral tools holder and padded headrest</i> <i>Chariot en plastique pour usine avec 6 roues pivotantes, avec porte outils latéral et appui-tête rembourré</i>
3080114B	Carrellino da officina completamente imbottito 7 ruote pivotanti, ripiegabile a sgabello. Poggiatesta regolabile <i>Workshop trolley completely padded with 7 pivoting wheels, folding as stool. Adjustable headrest</i> <i>Chariot pour usine complètement rembourré avec 7 roues pivotantes, pliant en tabouret. Appui-tête réglable</i>



3080114B



3080116 - accessori

3080116  
adattatori

**Smonta gomme**  
**Tyre changer - Démonte pneus**

Codice Code Code	Descrizione Description Description
3080116	Smonta gomme manuale "All-in-One" per pneumatici fino 22". Consente di cambiare pneumatici senza bisogno di aria compressa ed elettricità. Completo di adattatori ed accessori <i>Manual tire changer "All-in-One" for tyres up to 22". It allows to change tires without need of electricity or compressed air. Complete with adaptors and accessories</i> <i>Démonte pneus manuel "All-in-One" pour pneus jusqu'à 22 ».</i> <i>Il permet de changer les pneus sans besoin d'air comprimé et électricité. Complet d'adaptateurs et accessoires</i>



3080116



3080120



3080120B



3080120C



3080120D

**Supporti magnetici per attrezzature**  
**Magnetic stands for equipment**  
**Supports magnétiques pour équipement**

<b>Codice</b> Code Code	<b>Descrizione</b> Description Description
<b>3080120</b>	Set 3 vassoi magnetici 150-210-310 mm, fissabili singolarmente. Carico massimo 600gr, 800gr, 1200gr Set of 3 magnetic trays 150-210-310 mm, which can be fixed individually. Max. load 600gr, 800gr, 1200gr Jeu de 3 plateaux magnétiques 150-210-310 mm, fixables individuellement. Charge max. 600gr, 800gr, 1200gr
<b>3080120B</b>	Supporto magnetico per avvitatori pneumatici e bussole e chiavi dinamometriche. Portata 23kg Magnetic stand for impact wrenches and sockets and dynamometric wren- ches. Capacity 23kg Support magnétique pour clefs de vissage et douilles et clefs dynamométriques. Capacité 23kg
<b>3080120C</b>	Supporto magnetico per avvitatori pneumatici Magnetic stand for impact wrenches Support magnétique pour clefs de vissage
<b>3080120D</b>	Supporto magnetico porta utensili Magnetic stand to support tools Support magnétique porte outils
<b>3080120F</b>	Supporto magnetico porta rotoli in due pezzi. Portata 3kg, diametro rotolo 33mm Magnetic stand to support rolls in two pieces. Capacity 3kg, roll diameter 33mm Support magnétique porte rouleaux en deux pièces. Capacité 3kg, diamètre rouleau 33mm



3080120F



3120049

**Strumenti di emergenza**  
**Emergency tools**  
**Outils de secours**

Codice Code Code	Descrizione Description Description
3120049	Escape hammer con taglierina, martello frangi vetro, luce (intermittenza, fissa, allarme), supporto magnetico, impermeabile <i>Escape hammer with cutter and window hammer, light (flashlight, working light, alarm light), magnetic support, waterproof</i> <i>Escape hammer avec coupoir, marteau brise-verre, lumière / (intermittence, fixe, alarme), support magnétique, étanche</i>
3120049C	Utensile 4 in 1: martello, lama taglia cintura di sicurezza, luce lampeggiante, misuratore di pressione digitale (bar, psi, kpa) 0-10 bar <i>4 in 1 tool: hammer, seat belt cutter, flash light, digital pressure gauge (bar, psi, kpa) 0-10 bar</i> <i>Outil 4 en 1: marteau, lame coupe ceinture de sécurité, lumière clignotante, mesureur de pression digital (bar, psi, kpa) 0-10 bar</i>



3120049C

**Spessori per convergenza**  
**Shims for toe-in**  
**Épaisseurs pour pincement**

Codice Code Code	Descrizione Description Description	Cava mm Slot mm Rainure mm	Spessore mm Thickness mm Épaisseur mm	Pz. / scatola Pcs. / box Pcs. / boîte
3080010	Spessori per convergenza <i>Shims for toe-in</i> <i>Épaisseurs pour pincement</i>	10,5	0,5	200
3080012	Spessori per convergenza <i>Shims for toe-in</i> <i>Épaisseurs pour pincement</i>	10,5	1,5	200
3080014	Spessori per convergenza <i>Shims for toe-in</i> <i>Épaisseurs pour pincement</i>	12,5	0,5	200
3080016	Spessori per convergenza <i>Shims for toe-in</i> <i>Épaisseurs pour pincement</i>	12,5	1,5	200



3080010



3080016

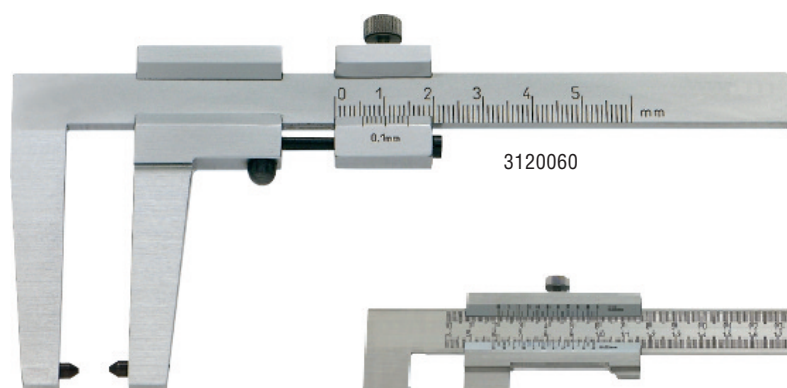

3120060

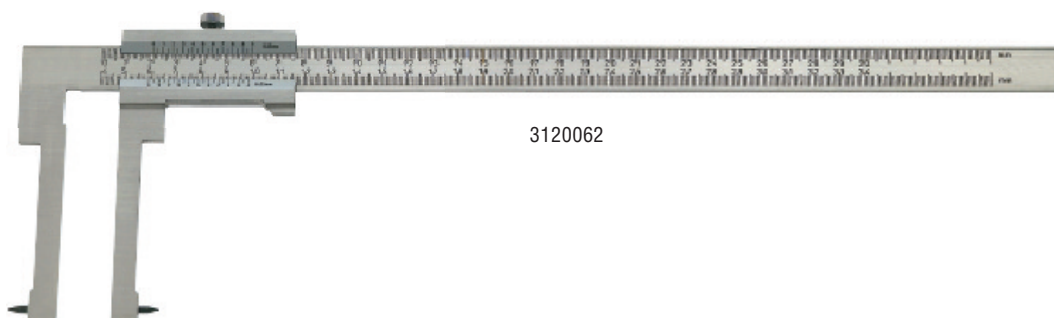

3120062

**Calibri e tester per freni**  
**Gauges and tester for brakes**  
**Calibres et testeur pour freins**

<b>Codice</b> Code Code	<b>Descrizione</b> Description Description
<b>3120060</b>	Calibro per misurazione spessore dischi freni (0-50 mm) con becchi 50 mm Gauge to measure thickness of brake discs (0-50 mm) with hooks 50 mm Calibre pour mesurer l'épaisseur des disques des freins (0-50 mm) avec crochets 50 mm
<b>3120062</b>	Calibro per tamburi freni interni (40-300 mm) con becchi 100 mm Gauge to measure internal brakes drums (40-300 mm) with hooks 100 mm Calibre pour mesurer les tambours des freins intérieurs (40-300 mm) avec crochets 100 mm
<b>3120064</b>	Calibro per tamburi freni interni (50-500 mm) con becchi 150 mm Gauge to measure internal brakes drums (50-500 mm) with hooks 150 mm Calibre pour mesurer les tambours des freins intérieurs (50-500 mm) avec crochets 150 mm
<b>3120070</b>	Tester liquido freni Brake fluid tester - Testeur du liquide des freins



3120070



3120083

**Chiave speciale ritorta ed inclinata per convergenza**  
**Special twisted and slanting wrench for toe-in**  
**Clef spéciale retorse et inclinée pour pincement**

<b>Codice</b> Code Code	<b>Descrizione</b> Description Description	<b>Lunghezza</b> Length Longueur
<b>3120080</b>	Chiave combinata Twist inclinata a 15° - 16mm Combined Twist wrench slanting at 15° - 16mm Clef combinée Twist inclinée à 15° - 16mm	243 mm
<b>3120081</b>	Chiave combinata Twist inclinata a 15° - 17mm Combined Twist wrench slanting at 15° - 17mm Clef combinée Twist inclinée à 15° - 17mm	262 mm
<b>3120082</b>	Chiave combinata Twist inclinata a 15° - 19mm Combined Twist wrench slanting at 15° - 19mm Clef combinée Twist inclinée à 15° - 19mm	281 mm
<b>3120083</b>	Chiave combinata Twist inclinata a 15° - 22mm Combined Twist wrench slanting at 15° - 22mm Clef combinée Twist inclinée à 15° - 22mm	319 mm



# CUFFIE UNIVERSALI PER GIUNTI

## UNIVERSAL SHROUDS FOR JOINTS

### CACHES UNIVERSELLES POUR JOINTS



3150070



3150072



3150072D



3150074



3150076



3150078



3150080



3150082

## Cuffie universali per giunti omocineticici

### Universal shrouds for homokinetic joints - Caches universelles pour joints homocinétiques

Codice Code Code	Descrizione Description Description	Rif. Ref. Réf.	Caratteristiche Features Caractéristiques
3150070	Kit cuffia universale per giunti omocineticici misura 50-76 mm composto da 1 cuffia, 1 sacchetto di grasso (70gr) e 2 anelli di serraggio <i>Universal shroud kit for homokinetic joints size 50-76 mm consisting of 1 shroud, 1 bag of grease (70gr) and 2 locking rings</i> <i>Kit cache universelle pour joints homocinétiques dimension 50-76 mm compose par 1 cache, 1 sachet de graisse (70gr) et 2 anneaux de serrage</i>	DG2000	Adatto per piccoli veicoli, minicar e quad e per il 70% dei veicoli Asiatici <i>Suitable for small vehicles, minicars and quads and for 70% of Asian vehicles</i> <i>Indiqué pour véhicules petits, minicar et quad et pour 70% des véhicules asiatiques</i>
3150072	Kit cuffia universale per giunti omocineticici misura 50-90 mm composto da 1 cuffia, 1 sacchetto di grasso (70gr) e 2 anelli di serraggio <i>Universal shroud kit for homokinetic joints size 50-90 mm consisting of 1 shroud, 1 bag of grease (70gr) and 2 locking rings</i> <i>Kit cache universelle pour joints homocinétiques dimension 50-90 mm compose par 1 cache, 1 sachet de graisse (70gr) et 2 anneaux de serrage</i>	DG3000	Ergonomico, perfetta tenuta, assoluta elasticità anche a basse temperature. Universalità lato ruota 99%. <i>Ergonomic, perfect sealing, absolute elasticity also at low temperatures. Universality on the wheel side 99%.</i> <i>Universalità lato scatola 85%</i> <i>Ergonomique, étanchéité parfaite, élasticité absolue aussi à températures basses. Universalité coté roue 99%.</i> <i>Universalité coté boîte 85%</i>
3150072D	Cartone di 12 kit DG3000 (12 DG3000) <i>Box of 12 kits DG3000 (12 DG3000)</i> <i>Boite à 12 kits DG3000 (12 DG3000)</i>	DG3000.12	
3150074	Kit cuffia universale per giunti omocineticici misura 70-130 mm composto da 1 cuffia, 1 sacchetto di grasso (90gr) e 2 anelli di serraggio <i>Universal shroud kit for homokinetic joints size 70-130 mm consisting of 1 shroud, 1 bag of grease (90gr) and 2 locking rings</i> <i>Kit cache universelle pour joints homocinétiques dimension 70-130 mm compose par 1 cache, 1 sachet de graisse (90gr) et 2 anneaux de serrage</i>	DG3001	Identiche caratteristiche del modello DG3000, universalità 98% del parco auto mondiale <i>Identical features of model DG3000, universality 98% of the worldwide car fleet</i> <i>Caractéristiques identiques au modèle DG3000, universalité 98% du parc voitures mondial</i>
3150076	Kit cuffia universale per cremagliere a gestione meccanica assistita misura 70-130 mm composto da 1 cuffia, 1 cono di montaggio e 3 fascette di serraggio in plastica <i>Universal shroud kit for racks with mechanical assisted running size 70-130 mm consisting of 1 shroud, 1 mounting cone and 3 plastic locking strips</i> <i>Kit cache universelle pour crémaillères à contrôle mécanique assisté dimension 70-130 composé par 1 cache, 1 cône de montage et 3 bandes de serrage en plastique</i>	DG4000	Non è necessario lo smontaggio dei componenti per applicarla, universalità 70% del parco auto mondiale <i>It is not necessary demounting the components to apply it, 70% universality of the worldwide car fleet</i> <i>Il n'est pas nécessaire de démonter les composantes pour l'appliquer, universalité 70% du parc voitures mondial</i>



3150084



3150090



3150086



3150088



3150092



3150094

<b>Codice</b> <i>Code</i> <i>Code</i>	<b>Descrizione</b> <i>Description</i> <i>Description</i>	<b>Rif.</b> <i>Ref.</i> <i>Réf.</i>	<b>Caratteristiche</b> <i>Features</i> <i>Caractéristiques</i>
<b>3150078</b>	Divaricatore pneumatico per montaggio cuffie giunti omocineticici <i>Pneumatic spreader to mount homokinetic joints shrouds</i> <i>Écarteur pneumatique pour montage caches joints homocinétiques</i>	DG06	Adatto al montaggio di giunti compresi tra 15 e 115 mm, in nylon e fibra di vetro, pressione massima 8 bar, attacco 1/4", peso 2,2 kg; comanda apertura e chiusura con un semplice pulsante, omologato CE <i>Suitable to mount joints included between 15 and 115 mm, in nylon and glass fiber, max. pressure 8 bar, connector 1/4", weight 2,2 kg; it controls the opening and closure by a simple pushbutton, EC homologated</i> <i>Indiqué pour le montage des joints inclus entre 15 et 115 mm, en nylon et fibre de verre, pression max. 8 bar, connexion 1/4 », poids 2,5 kg ; il contrôle l'ouverture et la fermeture par un bouton simple, homologué CE</i>
<b>3150080</b>	Cono articolato per il montaggio di DG2000 e DG3000 <i>Articulated cone for the assembling of DG2000 and DG3000</i> <i>Cone articulé pour le montage de DG2000 et DG3000</i>	DG02	Consente un montaggio rapido e senza fatica <i>It allows a quick mounting without effort</i> <i>Il permet un montage rapide sans fatigue</i>
<b>3150082</b>	Cono articolato per il montaggio di DG3001 <i>Articulated cone for the assembling of DG3001</i> <i>Cone articulé pour le montage de DG3001</i>	DG03	Consente un montaggio rapido e senza fatica <i>It allows a quick mounting without effort</i> <i>Il permet un montage rapide sans fatigue</i>
<b>3150084</b>	Attrezzo per il montaggio di DG4000 <i>Tool to mount DG4000</i> <i>Outil pour monter DG4000</i>	DG40	Tubo semirigido speciale per il montaggio delle cuffie per cremagliere; diametro 1 cm e lunghezza 40 cm <i>Semi-rigid special pipe to mount shrouds for racks; diameter 1 cm and length 40 cm</i> <i>Tuyau semi-rigide spécial pour le montage des caches pour crémaillères; diamètre 1 cm et longueur 40 cm</i>
<b>3150086</b>	Anelli di serraggio piccoli (100pz) <i>Small locking rings (100 pcs.)</i> <i>Anneaux de serrage petits (100 pcs.)</i>	DG5003	Diametro da 20 a 45 mm <i>Diameter from 20 to 45 mm</i> <i>Diamètre de 20 a 45 mm</i>
<b>3150088</b>	Anelli di serraggio grandi (50pz) <i>Large locking rings (50 pcs.)</i> <i>Anneaux de serrage grands (50 pcs.)</i>	DG5004	Diametro da 45 a 120 mm <i>Diameter from 45 to 120 mm</i> <i>Diamètre de 45 a 120 mm</i>
<b>3150090</b>	Kit anelli di serraggio (1 pz piccolo e 1 pz grande) <i>Kit of locking rings (1 pc. Small and 1 pc. Large)</i> <i>Kit d'anneaux de serrage (1 pc. Petite et 1 pc. Grande)</i>	DG4579	
<b>3150092</b>	Sacchetto di grasso neutro 70gr <i>Neutral grease bag 70gr</i> <i>Sachet de graisse neutre 70gr</i>	DG70	
<b>3150094</b>	Sacchetto di grasso neutro 90gr <i>Neutral grease bag 90gr</i> <i>Sachet de graisse neutre 90gr</i>	DG90	



# DET NORSKE VERITAS

## QUALITY MANAGEMENT SYSTEM CERTIFICATE

Certificato No. / Certificate No. **CERT-07870-2001-AQ-MIL-SINCERT**

Si attesta che / This certifies that

Il sistema di gestione per la qualità di / the quality management system of  
**ITALMATIC S.r.l.**

**Villa Pompea, 31 - 20060 Cassina de' Pecchi (MI) - Italy**

È conforme ai requisiti della norma per i sistemi di gestione per la qualità  
Conforms to the quality management systems standard

**UNI EN ISO 9001:2008 (ISO 9001:2008)**

Questa certificazione è valida per il seguente campo applicativo:  
This certificate is valid for the following products or services:

*(Ulteriori chiarimenti riguardanti lo scopo e l'applicabilità dei requisiti della normativa si possono ottenere consultando l'organizzazione certificata)  
(Further clarifications regarding the scope and the applicability of the requirements of the standard(s) may be obtained by consulting the certified organization)*

**Produzione e vendita di contrappesi per equilibratura ruote**  
**Manufacture and sales of wheel balancing weights**

Data Prima Emissione

First Issue Date

**2001-02-05**

Luogo e data  
Place and date

**Agrate Brianza, (MB) 2011-08-23**

**Settore EA : 22 a - 17**

**Armando Tarozzi**

*Lead Auditor*



SGQ N°003 A PRD N°003 B  
SGA N°003 D SSI N°002 G  
SCR N°004 F FSM N°001 I

Membro di MLA EA per gli schemi di accreditamento SGQ,  
SGA, PRD, PRS, ISP e LAB, di MLA IAF per gli schemi di  
accreditamento SGQ, SGA, SSI, FSM e PRD  
e di PRA ILAC per gli schemi di accreditamento LAB

Data di scadenza

Expiry Date

**2014-07-18**

per l'Organismo di Certificazione  
for the Accredited Unit

**DET NORSKE VERITAS ITALIA S.R.L.**

**Zeno Beltrami**

*Management Representative*

La validità del presente certificato è subordinata a sorveglianza periodica (ogni 6, 9 o 12 mesi) e al riesame completo del sistema con periodicità triennale

The validity of this certificate is subject to periodical audits (every 6, 9 or 12 months) and the complete re-assessment of the system every three years

Le aziende in possesso di un certificato valido sono presenti nella banca dati sul sito [www.dnv.it](http://www.dnv.it) e sul sito [Accredia \(www.accredia.it\)](http://www.accredia.it) - All the companies with a valid certificate are online at the following addresses: [www.dnv.it](http://www.dnv.it) and [www.accredia.it](http://www.accredia.it)



---

# DET NORSKE VERITAS

---

## MANAGEMENT SYSTEM CERTIFICATE

---

Certificate No.: 100743-2011-AQ-ITA-IATF

IATF Certificate No.: 0124257

Page 1 of 1

*This is to certify that the Management System of:*

**Italmatic S.r.l.**

Via dell'Artigianato, 8A - 20060 Cassina de' Pecchi (MI), Italy

*Supporting Site Extensions: None*

*Remote Supporting Functions: None*

*has been found to conform to Technical Specification:*

**ISO/TS 16949:2009**

*having been audited in accordance with the:*

*Rules for the registration scheme for ISO/TS 16949:2009 – 3<sup>rd</sup> Edition.*

*This Certificate is valid for the following products/service ranges*

**MANUFACTURING OF WHEEL BALANCING WEIGHTS**

**EXCLUSION: 7.3 PRODUCT DESIGN**

*Initial Certification date:*

19 July 2011

*This Certificate is valid until:*

18 July 2014

**Armando Tarozzi**

Armando Tarozzi

*Lead Auditor*



*Place and Validity Start date:*

Katy, Texas, 19 July 2011

*for the Accredited Unit*

DET NORSKE VERITAS  
CERTIFICATION INC., KATY, TX, USA

Robert Kozak

*Management Representative*

*Audit Conducted by DNV Office located in Milan, Italy*

PRODOTTO	PAGINA
<b>A</b>	
accessori antinfortunistica	37
accessori da taglio	24
accessori per autoclavi e cilindri	35
accessori per valvole	113-115
anelli di montaggio per tubeless	162
attacchi e raccordi	29
attrezzi montaggio /smontaggio valvole	121, 123
attrezzi per contrappesi	128-129
attrezzi riempimento/svuotamento acqua	122
avvitatori	82-83, 181
avvolgitori cavi elettrici	74
<b>B-C</b>	
bead booster	175
bussole	79-81, 83-84
calibri	30
calibri e tester per freni	183
camere di cottura	38-39
carrelli per movimentazione pneumatici	177
cassettiere porta attrezzi	103, 157, 178
cavalletti e supporti per moto	55, 179
chiavi a croce	78
chiavi dinamometriche	85
chiavi ritorte per convergenza	183
chiodi per ghiaccio	75
connettori, indicatori di controllo dadi	124
contrappesi di bilanciatura in ferro	139-141, 142
contrappesi di bilanciatura in piombo	130-134
contrappesi di bilanciatura in stagno	138, 142
contrappesi di bilanciatura in zinco	135-138, 142
coperchietti per dadi	125
cricchi a bottiglia	50-51
cricchi a carrello	52-54
cuffie universali per giunti omocineticici	184-185
cuscini per vuoto envelope	45
<b>D-E</b>	
dispositivi di gonfiaggio aria azoto	70-71
distanziali per raspe	11
divaricatore pneumatici	159, 176
durometro per gomma	31
envelopes esterni	41-42
envelopes interni	43
envelopes interni per gomme piene	44
estrusore tubeless per riparazioni	18
estrusori portatili	17-18
etichette per identificazione e RFID	162
<b>F-G-H-I-J-K</b>	
fasce in gomma nera per mandrini	33
fustini di cottura	40
gabbia di sicurezza	176
gessi e pennarelli per pneumatici	170
gomma per estrusore portatile	18

PRODOTTO	PAGINA
gonfiagomme portatili	73
graffatrice pneumatica	36
guarnizioni	30
guarnizioni per autoclavi	34
<b>L-M-N-O</b>	
lame di rasatura	8-9
lame per rigatore	64
lamette	25
lampade	74, 182
lettini carrellati da officina	180
leve per pneumatici autocarro e M.T.	77
leve per pneumatici vettura	76
marcatore elettrico	32
materiale di riparazione a caldo	167
materiale di riparazione autovulcanizzante	146-161
metri decimali	31
microsfere di bilanciatura autocarro	143-144
misuratori battistrada	122
misuratori di pressione	68-69, 182
mole cabide	13-16
mole per metallo e gomma	21
moltiplicatore di forza	78
OR per movimento terra	162
<b>P-Q</b>	
pasta montaggio pneumatici	168-169
perni zigrinati	11
pezze di bilanciatura pneumatici avio	163
piastri di fissaggio	120
piattaforme, tavoli e cuscini di sollevamento	55, 179
pistola chiodatrice	75
pistole di gonfiaggio	66-67
pistole per soffiaggio aria	73
pistole spurazzapara	26
portalamette	25
prodotti per riparazioni di emergenza	158, 172
prolunghe in gomma	116-117
prolunghe in ottone	119-120
prolunghe in plastica	118
prolunghe rivestite in acciaio	119
protezioni per interni	173
pulitori e lucidanti pneumatici e cerchi	171
punte in acciaio per raspe e rullini	8
<b>R</b>	
raccordi di gonfiaggio	121
raspe	10
rigatori	63-65
rilevatore forature	171
rotoli di carta	173, 181
rubinetti	30
rullini e raspette a punte intercambiabili	22
rullini zigrinati, lisci e da taglio	22
ruote per carriole	60

PRODOTTO	PAGINA
ruote per piccoli carrelli	59
<b>S</b>	
sacchi porta ruota	173
scorticatori cilindrici e conici	12
sgorbie	12
silicone per presse	33
smergiliatrici professionali Uryu	23
smonta gomme manuale All-in-One	180
sollevatore per pneumatici	176
soluzioni e solventi per ricostruzione	36, 46-48
spazzole gommate e abrasive	20
spazzole ottonate	19
spazzole parapolverino	36
spessori per convergenza	182
spray sbloccante e pulitore freni e colla	171
stallonatori	174
strumenti di emergenza	182
supporti magnetici porta attrezzature	181
svita interni valvola	121
<b>T-U</b>	
tagliacoperture	175
tamponi in gomma per ponti sollevatori	56-57
tamponi per stazionamento	58
tasselli e colonnette	126-127
termometri	31
TPMS - sensori OE Huf (Beru)	93-94
TPMS - sensori OE Schrader e VDO	95-102
TPMS - sensori universali EZ Sensor	104-105
TPMS - sensori universali Sens.it	92
tubi aria e avvolgitori	72
tubi speciali e accessori	26
tubi teflon	27
<b>V-W-X-Y-Z</b>	
valvole avvitabili per camera d'aria	110-111
valvole genio civile	112
valvole in metallo per pneumatici auto	87
valvole invisibili	90
valvole metallo autocarro	106-109
valvole per camere di cottura	27
valvole per envelopes	28
valvole per moto	90
valvole per serbatoi	119
valvole per veicoli commerciali	88-89
valvole trattore	111
valvole tubeless in gomma per auto	86
vasca prova pneumatici	175
vernice nera a base d'acqua	48
vulcanizzatori	61-62

PRODUCT	PAGE	PRODUCT	PAGE	PRODUCT	PAGE
<b>A</b>		<b>L-M-N-O</b>		<b>T-U</b>	
accessories for auclaves and rollers	35	lamps	74, 182	steel nails for rasps and rollers	8
accessories for industrial accidents prevention	37	lead balancing weights	130-134	stitchers and rasps with interchangeable pins	22
accessories for valves	113-115	levers for car tyres	76	studs for ice	75
air blowing guns	73	levers for truck tyres and E.M.	77	<b>T-U</b>	
air hoses and winders	72	lifting platforms, tables and pads	55, 179	taps	30
<b>B-C</b>		magnetic stands for equipment	181	teflon hoses	27
balance pads for avio tyres	163	material for hot reparing	167	thermometers	31
balancing weights	130-142	metal valves for car tyres	87	tin balancing weights	138, 142
bead boosters	175	mounting paste	168-169	tire cutter	175
bead breakers	174	mounting rings for tubeless	162	tool for valve mounting/dismounting	121, 123
blades for regroover	64	nut caps	125	tools for balancing weights	128-129
bottle jacks	50-51	nut check connectors and indicators	124	tools for cutting	24
brass brushes	19	OR for E.M.	162	tools for water filling/emptying	122
brass extensions	119-120	outer envelopes	41-42	TPMS - universal sensors EZ Sensor	104-105
brushes (rubber and abrasive)	20	<b>P-Q</b>		TPMS - universal sensors Sens.it	92
brushes for rubber dust	36	pads for parking	58	TPMS - sensors OEM Huf (Beru)	93-94
buffing blades	8-9	paper on reel	173, 181	TPMS - sensors OEM Schrader and VDO	95-102
carbide wheels	13-16	para rubber gun	26	tractor valves	111
cement and solvent for retreading	36, 46-48	peeling teeth	12	tread measurers	122
chalks and marking pen for tyres	170	plastic extensions	118	trimming blades	25
chests of drawers for tools	103, 157, 178	pneumatic stapler	36	trolley jacks	52-54
cleaners and polish for tyre and wheel	171	portable extruders	17-18	trolley tables for workshop	180
connettors and couplers	29	portable inflators	73	trolleys for tyres moving	177
cross wrenches	78	pressure measurers	68-69, 182	truck metal valves	106-109
curing bladders	40	products for emergency repairing	158,172	truck tyre balancing microbeads	143-144
curing tubes	38-39	professional grinders Uryu	23	tubeless extruder for repairing	18
<b>D-E</b>		protections for interior compartments	173	twisted wrenches for toe-in	183
decimal meters	31	puncture leaks detector	171	tyre changer All-in-One (manual)	180
dynamometric wrench	85	<b>R</b>		tyre containing bags	173
electric cable winders	74	rasp spacers	11	tyre for wheel barrows	60
electric marker	32	rasps	10	tyre identification labels and RFID	162
emergency tools	182	regroovers	63-65	tyre lifter	176
envelope vacuum pads	45	repairing material self curing	146-161	tyre spreader	159, 176
<b>F-G-H-I-J-K</b>		riveting gun	75	tyre test tank	175
fixing plates	120	rubber bands for standard chucks	33	tyre trimming tools	25
force multiplier	78	rubber extensions	116-117	tyres for small trolleys	59
gaskets	30	rubber for portable extruder	18	universal shrouds for homokinetic joints	184-185
gauges	30	rubber pads for auto lifts	56-57	unlocking spray and cleaner for brakes and glue	171
gauges and tester for brakes	183	rubber tubeless valves for car tyres	86	<b>V-W-X-Y-Z</b>	
gouges	12	<b>S</b>		valve for tanks	119
harness measuring dvice for rubber	31	safety cage	176	valves E.M.	112
impact sockets	79-81, 83-84	screwdrivers for valve core	121	valves for commercial vehicles	88-89
impact wrenches	82-83, 181	seals for autoclaves	34	valves for curing tubes	27
inflating connectors	121	serrated, smooth, and cutting stitchers	22	valves for envelopes	28
inflating devices air and nitrogen	70-71	shims for toe-in	182	valves for motorcycle	90
inflating guns	66-67	silicon for presses	33	valves to be screwed for tubes	110-111
inner envelopes	43	small blocks and studs	126-127	vulcanizers	61-62
inner envelopes for solid tyres	44	special hoses and accessories	26	water based tyre paint	48
invisible valves	90	stands to hold motorcycles	55, 179	wheels for metallic and rubber	21
knurled pins	11	steel balancing weights	139-141, 142	zinc balancing weights	135-138, 142
		steel coated extensions	119		

PRODUIT	PAGE
<b>A</b>	
accessoires pour la prévention des accidents sur le travail	37
accessoires pour valves	113-115
accessories à couper	24
accessories pour autoclaves et cylindres	35
agrafeuse pneumatique	36
aiguilles en acier pour râpes et rouleaux	8
anneaux de montage pour tubeless	162
<b>B-C</b>	
bandes en caoutchouc noir pour mandrins standard	33
bead booster	175
bouchons pour écrous	125
brosses (en caoutchouc et abrasive)	20
brosses cuivrées	19
brosses pour poudrette	36
cache universelles pour joints homocinétiques	184-185
cage de sécurité	176
calibres	30
calibres et testeur pour freins	183
caoutchouc pour extrudeuses portative	18
chambres de cuisson	38-39
chariots pour le mouvement des pneus	177
chevalet porte motorcycle	55, 179
clefs de vissage	82-83, 181
clefs dynamométrique	85
clefs en form de croix	78
clefs retorse pour pincement	183
clous pour neige	75
connecteurs et indicateurs pour écrous	124
connecteur de gonflage	121
connecteurs et raccords	29
coussins pour vide enveloppe	45
craies et stylos de marquage pour pneus	170
crics à bouteille	50-51
crics à chariot	52-54
cuves pour essai pneus	175
<b>D-E</b>	
démonte de pneus All-in-One (manuel)	180
détalonneurs	174
détecteur de pertes	171
dispositif électrique pour marquer	32
dispositif pour dévisser les valves	121
dispositifs de gonflage air et azote	70-71
douilles	79-81, 83-84
écarte-pneus	159, 176
écorcheurs	12
élévateur pour pneus	176
enrouleurs de câbles électriques	74
envelopes extérieurs	41-42
envelopes intérieurs	43

PRODUIT	PAGE
envelopes intérieurs pour pneus pleins	44
épaisseurs pour pincement	182
étiquettes pour identification pneus et RFID	162
extensions en plastique	118
extrudeuses portatives	17-18
extrudeuses tubeless pour réparation	18
<b>F-G-H-I-J-K</b>	
gonfleurs portables	73
gouges	12
goujons crénelée	11
intercalaires pour râpes	11
joints	30
joints pour autoclaves	34
<b>L-M-N-O</b>	
lames à ébarber	25
lames de râpage	8-9
lames pour sculpteur	64
lampes	74, 182
leviers pour pneus camion et G.C.	77
leviers pour pneus tourisme	76
machine à découper les pneus	175
masses d'équilibrage en acier	139-141, 142
masses d'équilibrage en étain	138, 142
masses d'équilibrage en zinc	135-138, 142
masses d'équilibrage plomb	130-134
matériel pour réparation à chaud	167
matériel vulcanisant pour réparation	146-161
membranes de cuisson	40
mesure de dureté pour caoutchouc	31
mesureurs de la chape	122
mesureurs de pression	68-69, 182
mètres décimaux	31
meules	13-16
meules pour métal et caoutchouc	21
microsphère d'équilibrage camion	143-144
multiplicateur de force	78
OR pour P.L.	162
outils de secours	182
outils pour monter/démonter valves	121, 123
outils pour masses d'équilibrage	128-129
outils pour remplissage/vidage eau	122
<b>P-Q</b>	
papier sur bobine	173, 181
pâte pour le montage	168-169
pattes de fixation	120
peinture réactivante à base d'eau	48
petit blocs et boulons	126-127
pistolet de clouage	75
pistolet de gonflage	66-67
pistolet pour caoutchouc	26
pistolets pour soufflage air	73
plate-formes, tables et coussins de levage	55, 179

PRODUIT	PAGE
pneus pour brouettes	60
pneus pour petit chariots	59
polisseur-cireurs pour pneus et jantes	171
Ponceuses professionnelles Uryu	23
porte-lames à ébarber	25
produits pour réparation d'urgence	158, 172
protections pour habitacles	173
<b>R</b>	
rallonges en caoutchouc	116-117
rallonges en laiton	119-120
rallonges habillée en acier	119
râpes	10
robinets	30
rouleaux crénelés, lisses et à couper	22
rouleaux et râpes à aiguilles interchangeableables	22
<b>S</b>	
sacs porte pneus	173
silicone pour presses	33
solution et solvant pour rechapage	36, 46-48
sulpteur pneus	63-65
support magnétiques pour équipement	181
<b>T-U</b>	
tables à chariot pour usine	180
tampons d'équilibrage pour pneus avion	163
tampons en caoutchouc pour ponts élévateurs	56-57
tampons pour stationnement	58
thermomètres	31
tiroirs port outils	103, 157, 178
TPMS - capteurs EZ Sensor universel	104-105
TPMS - capteurs OEM Huf (Beru)	93-94
TPMS - capteurs OEM Schrader et VDO	95-102
TPMS - capteurs Sens.it universel	92
tuyaux air et enrouleurs	72
tuyaux en teflon	27
tuyaux spéciaux et accessoires	26
<b>V-W-X-Y-Z</b>	
valves à visser pour chambre à air	110-111
valves camion en laiton	106-109
valves en métal pour voiture	87
valves Génie Civil	112
valves invisibles	90
valves pour chambres de cuisson	27
valves pour envelopes	28
valves pour motocyclettes	90
valves pour réservoirs	119
valves pour tracteur	111
valves pour véhicules commerciaux	88-89
valves tubeless en caoutchouc pour voiture	86
vaporisateur débloquent et polissent pour freins et colle	171
vulcanisateurs	61-62









[www.italmatic.net](http://www.italmatic.net)



HEAD OFFICE & PRODUCTION PLANT:  
**ITALMATIC S.R.L.**  
Via dell'Artigianato, 8A  
20060 Cassina de' Pecchi (MI) - ITALY  
Tel.: +39 02 95300545  
Fax: +39 02 95300199  
E-mail: [mail@italmatic.net](mailto:mail@italmatic.net)



PRODUCTION PLANT:  
**ITALMATIC PRESSE STAMPI S.R.L.**  
Via Tazio Nuvolari s.n.  
55061 Frazione Carraia - Capannori (LU) - ITALY  
Tel.: +39 0583 981166  
Fax: +39 0583 981080

***italmatic***®  
***italmatic***®